

FLM R22+

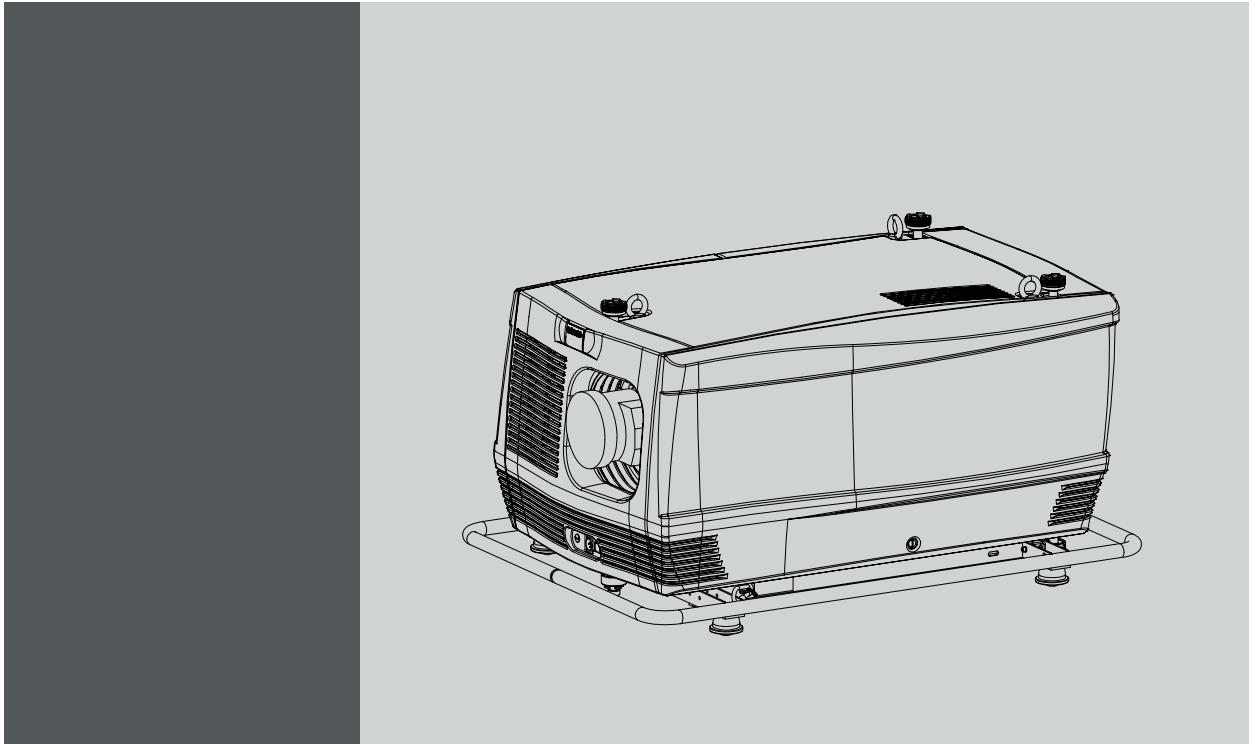

User guide

R9004500

Barco nv Media & Entertainment Division

Noordlaan 5, B-8520 Kuurne

Phone: +32 56.36.82.11

Fax: +32 56.36.883.86

E-mail: sales.events@barco.com

Visit us at the web: www.barco.com

Changes

Barco provides this manual 'as is' without warranty of any kind, either expressed or implied, including but not limited to the implied warranties or merchantability and fitness for a particular purpose. Barco may make improvements and/or changes to the product(s) and/or the program(s) described in this publication at any time without notice.

This publication could contain technical inaccuracies or typographical errors. Changes are periodically made to the information in this publication; these changes are incorporated in new editions of this publication.

Copyright ©

All rights reserved. No part of this document may be copied, reproduced or translated. It shall not otherwise be recorded, transmitted or stored in a retrieval system without the prior written consent of Barco.

Trademarks

Brand and product names mentioned in this manual may be trademarks, registered trademarks or copyrights of their respective holders. All brand and product names mentioned in this manual serve as comments or examples and are not to be understood as advertising for the products or their manufacturers.

Federal Communications Commission (FCC Statement)

This equipment has been tested and found to comply with the limits for a class A digital device, pursuant to Part 15 of the FCC rules. These limits are designed to provide reasonable protection against harmful interference when the equipment is operated in a commercial environment. This equipment generates, uses, and can radiate radio frequency energy and, if not installed and used in accordance with the instruction manual, may cause harmful interference to radio communications. Operation of this equipment in a residential area may cause harmful interference, in which case the user will be responsible for correcting any interference at his own expense

EN55022/CISPR22 Class A ITE (Information Technology Equipment)

Class A ITE is a category of all other ITE which satisfies the class A ITE limits but not the class B ITE limits. Such equipment should not be restricted in its sale but the following warning shall be included in the instructions for use:

Warning : This is a class A product. In a domestic environment this product may cause radio interference in which case the user may be required to take adequate measures.

Software License Agreement

You should carefully read the following terms and conditions before using this software. Your use of this software indicates your acceptance of this license agreement and warranty.

Terms and Conditions:

1. No redistribution of the software is allowed.
2. Reverse-Engineering. You may not reverse engineer, decompile, disassemble or alter anyhow this software product.

Disclaimer of Warranty:

This software and the accompanying files are sold "as is" and without warranties as to performance or merchantability or any other warranties whether expressed or implied. In no event shall Barco be liable for damage of any kind, loss of data, loss of profits, business interruption or other pecuniary loss arising directly or indirectly. Any liability of the seller will be exclusively limited to replacement of the product or refund of purchase price.

GNU-GPL code

If you would like a copy of the GPL source code contained in this product shipped to you on CD, please contact Barco. The cost of preparing and mailing a CD will be charged.

Disposal Information

This equipment has required the extraction and use of natural resources for its production. It may contain hazardous substances for health and environment. In order to avoid the dissemination of those substances in the environment and to diminish the pressure on natural resources, we encourage you to use the appropriate take-back systems. Those systems will reuse or recycle most of the materials of your end of life equipment in a sound way.



The crossed-out wheeled bin symbol invites you to use those systems. If you need more information on the collection, reuse and recycling systems, please contact your local or regional waste administrator. You can also contact us for more information on the environmental performances of our products.

TABLE OF CONTENTS

1. Safety	5
1.1 General	5
1.2 Important safety instructions	6
1.3 Important warnings concerning FLM flight cases	9
2. General	11
2.1 Installation requirements	11
2.2 Unpacking the projector	12
2.3 Box content	13
2.4 FLM flight case	14
2.5 Projector configurations	14
2.6 Projector air inlets and outlets	18
2.7 Free download of Projector Toolset	18
3. Physical installation	19
3.1 Remote control unit (RCU)	19
3.1.1 RCU battery installation	20
3.1.2 RCU rugged case installation	21
3.1.3 RCU XLR adaptor installation	21
3.1.4 Using the XLR adaptor of the RCU	21
3.1.5 RCU usage possibilities	22
3.2 Lenses	23
3.2.1 Available lenses	23
3.2.2 Lens selection	23
3.2.3 Lens formulas	24
3.2.4 Lens installation	24
3.2.5 Lens removal	26
3.3 Alignment of a table mount FLM projector	27
3.4 Alignment of a ceiling mount FLM projector	27
3.5 Suspension of the FLM projector with rigging clamps	28
4. Stacking FLM projectors	31
4.1 Stacking FLM projectors	31
4.2 Aligning stacked FLM projectors	33
5. Connections	35
5.1 Power connection	35
5.2 Input source connections	37
5.3 Communication connections	38
6. Getting started	43
6.1 RCU & Local keypad	43
6.2 Terminology overview	43
6.3 Operating the projector	45
6.3.1 Switching on	45
6.3.2 Errors, warnings and messages during start up	46
6.3.3 Switching to standby	46
6.3.4 Switching off	47
6.4 Using the RCU	47
6.5 Quick setup adjustments	49
6.5.1 Text boxes ON or OFF	49
6.5.2 Quick Lens Adjustment	49
6.5.2.1 Quick Lens Adjustment via LENS key	49
6.5.2.2 Direct Lens Adjustment (RCU)	50
6.5.3 Quick picture in picture	50
6.5.4 Quick layout selection with Rigging key	51
6.5.5 Quick language selection	51
6.6 Projector Address	52
6.6.1 Displaying and Programming addresses	52
6.6.2 Controlling the projector	53
6.7 Source selection	53
6.8 Controlling the Projector	54
7. Start up of the Adjustment Mode	55
7.1 About the adjustment mode	55
7.2 About the use of the remote control and the local keypad	55
7.3 Start up the adjustment mode	55
7.4 Navigation and adjustments	56
7.5 Shortcut keys to the menus	56
7.6 On screen menus versus LCD display menus	57
7.7 Test patterns in adjustment mode	57
7.8 Menu memory	57

8. Input menu	59
8.1 Overview flow	59
8.2 Slot module type	59
8.2.1 About Input Setup	59
8.2.2 Input configuration	60
8.3 Input locking	61
8.4 Minimum delay	63
8.5 Native resolution	63
8.6 Source switching	65
8.7 No signal	65
8.7.1 Background color	65
8.7.2 Shutdown setting	66
8.7.3 Shutdown retarding time	66
9. Image menu	69
9.1 Overview flow	69
9.2 How to select the image adjustments?	70
9.3 Image Settings	70
9.3.1 Contrast	71
9.3.2 Brightness	71
9.3.3 Saturation	72
9.3.4 Tint (hue)	73
9.3.5 Phase	73
9.3.6 Sharpness	74
9.3.7 Noise reduction	75
9.3.8 Color temperature	76
9.3.8.1 Predefined color temperature	76
9.3.8.2 Set a custom color temperature	77
9.3.9 Input balance	78
9.3.9.1 Introduction to Input Balance	78
9.3.9.2 Adjusting the input balance	79
9.4 Aspect ratio	82
9.5 Timings	83
9.5.1 Source timings	83
9.5.2 Advanced settings	84
9.5.3 Advanced settings, film mode detection	86
9.6 Image files services	88
9.6.1 Files and file manipulations	88
9.6.2 Manual Load file	88
9.6.3 Delete file	89
9.6.4 Delete all custom files	90
9.6.5 Rename a file	90
9.6.6 Copy a file	91
9.6.7 File options	92
9.7 Save custom settings	93
10. Layout menu	95
10.1 Overview flow	95
10.2 Main window	95
10.2.1 Source selection	96
10.2.2 Size adjustment	96
10.2.3 Position adjustment	99
10.3 PIP window	100
10.3.1 Introduction to PIP	100
10.3.2 Picture in Picture activation	101
10.3.3 Picture in Picture source selection	101
10.3.4 Picture in Picture size of the window	102
10.3.5 Picture in Picture, position window	105
10.4 Layout file services	106
10.4.1 Load layout	106
10.4.2 Rename a layout	107
10.4.3 Delete a layout	107
10.4.4 Copy / Save as a layout	108
10.5 Zoom - Focus	109
11. Lamp menu	111
11.1 Overview flow	111
11.2 Lamp power mode	111
11.3 Lamp power	112
11.4 Constant Light Output mode (CLO mode)	113
11.5 CLO target	114
11.6 Lamp Identification	114
11.7 Z-axis adjustment	115
12. Alignment menu	117
12.1 Overview flow	117
12.2 Orientation	118

12.3	Lens adjustment	119
12.4	Side keystone	120
12.5	Warp geometry settings	121
12.5.1	About Warp geometry settings	121
12.5.2	Warp Status	122
12.5.3	Horizontal keystone correction	123
12.5.4	Vertical keystone correction	124
12.5.5	Rotation	125
12.5.6	Pincushion - Barrel correction	126
12.5.7	4 corner correction	127
12.5.8	Reset warp settings	128
12.5.9	Load warp file	129
12.6	Contrast enhancement	130
12.7	Blanking	130
12.8	Gamma	132
12.9	Internal pattern	132
12.10	Color space	133
12.11	ScenergiX	134
12.11.1	Introduction	134
12.11.2	Preparations	135
12.11.3	ScenergiX activation	135
12.11.4	ScenergiX overlap zone (horizontal ScenergiX)	136
12.11.5	ScenergiX overlap zone (vertical ScenergiX)	137
12.11.6	ScenergiX size adjustment (White level)	139
12.11.7	Adjusting the black level of the images	141
13.	Projector control	145
13.1	Overview flow	145
13.2	Projector address	146
13.2.1	Individual projector address	146
13.2.2	Common address	147
13.3	Serial communication	148
13.3.1	Baud rate setup	148
13.3.2	Interface standard	148
13.3.3	RS422 termination	149
13.4	Network	149
13.4.1	Introduction to a Network connection	150
13.4.2	DHCP setup	150
13.4.3	IP-address set up	151
13.4.4	Subnet-mask set up	151
13.4.5	Default Gateway set up	152
13.5	IR control switching	153
13.6	Art-Net DMX	153
13.6.1	DMX address	154
13.6.2	DMX universe	154
13.6.3	DMX monitor	155
13.6.4	DMX mode	156
13.6.5	Art-Net activation	157
13.6.6	Home lens at startup	157
13.7	Buttons	158
13.7.1	Standby button	158
13.7.2	APA (auto) button	159
13.7.3	Shortcut keys	159
13.8	Menu position	160
13.8.1	On screen menu	160
13.8.2	Bar scale	161
13.9	Local LCD	161
13.9.1	Local LCD time out	161
13.9.2	Local LCD contrast	162
13.10	Language selection	162
14.	Service menu	165
14.1	Overview flow	165
14.2	Identification	166
14.3	Diagnosis	167
14.3.1	How to start up the diagnosis?	167
14.3.2	Versions	167
14.3.3	Voltages	168
14.3.4	I ² C diagnosis	169
14.3.5	Temperatures	169
14.3.6	Fan speeds overview	170
14.3.7	SPI	171
14.3.8	Error logging overview	172
14.4	Convergence	172
14.5	Internal service patterns	173
14.6	Restore factory defaults	174

14.7	Reset formatter	175
14.8	Save custom settings	176
14.9	Refill mode	176
14.10	Broadcast mode	177
14.11	USB memory	178
15.	Maintenance	181
15.1	Replacement of the dust filter on the front side	181
15.2	Replacement of the dust filter on the bottom side	182
15.3	Replacement of the dust filter on the top side	183
15.4	Pressure verification of the liquid cooling circuit	183
15.5	Cleaning the lens	184
15.6	Cleaning the exterior of the projector	184
16.	Servicing	185
16.1	Removal of the lamp house	185
16.2	Removal of the input & communication unit	186
16.3	Removal of an input module	187
16.4	Installation of the lamp house	188
16.5	Installation of the input & communication unit	189
16.6	Installation of an input module	190
16.7	Realignment of the lamp in its reflector	191
17.	Removal of the projector covers	193
17.1	Removal of the front cover	193
17.2	Removal of the side cover	194
17.3	Removal of the lamp cover	195
17.4	Removal of the input cover	195
17.5	Installation of the front cover	196
17.6	Installation of the side cover	197
17.7	Installation of the lamp cover	198
17.8	Installation of the input cover	199
18.	Dimensions	201
18.1	Dimensions of the FLM R22+	201
18.2	Dimensions of the FLM flight case	202
18.3	Dimensions of the rigging clamps	203
19.	Standard Source Files	205
19.1	Table overview	205
20.	DMX chart	207
20.1	DMX chart, basic	207
20.2	DMX chart, Extended	208
20.3	DMX chart, Full	209
21.	Troubleshooting	213
21.1	Error codes	213
22.	Specifications	221
22.1	Specifications FLM R22+	221
22.2	Specifications FLM 5 cable input (multi purpose)	224
22.3	Specifications FLM HDSI – SDI input	225
22.4	Specifications FLM DVI input	226
22.5	Specifications FLM DVI HDCP input	227
23.	Order information	229
23.1	Spare part order info	229
Glossary		231
Index		233

1. SAFETY

1.1 General



WARNING: Ensure you understand and follow all the safety guidelines, safety instructions, warnings and cautions mentioned in this manual.



WARNING: Be aware of suspended loads.



WARNING: Wear a hard hat to reduce the risk of personal injury.



WARNING: Be careful while working with heavy loads.



WARNING: Mind your fingers while working with heavy loads.



CAUTION: High pressure lamp may explode if improperly handled.

Notice on safety

This equipment is built in accordance with the requirements of the international safety standards IEC60950-1, EN60950-1, UL60950-1 and CAN/CSA C22.2 No.60950-1, which are the safety standards of information technology equipment including electrical business equipment. These safety standards impose important requirements on the use of safety critical components, materials and insulation, in order to protect the user or operator against risk of electric shock and energy hazard, and having access to live parts. Safety standards also impose limits to the internal and external temperature rises, radiation levels, mechanical stability and strength, enclosure construction and protection against the risk of fire. Simulated single fault condition testing ensures the safety of the equipment to the user even when the equipment's normal operation fails.

Restricted access location

The FLM R22+ must be installed in a restricted access location, due to the temperature rise of parts of the equipment (air outlet).



Restricted access location

A location for equipment where both of the following paragraphs apply:

- 1) Access can only be gained by SERVICE PERSONS or by USERS who have been instructed about the reasons for the restriction applied to the location and about the precautions that shall be taken.
- 2) Access is through the use of the tool or lock and key, or other means of security, and is controlled by the authority responsible for the location.

1.2 Important safety instructions

To prevent the risk of electrical shock

- This product should be operated from a mono phase AC power source. Power input voltage range must be between 200-240 VAC, 50–60 Hz, 18 amps at 230 VAC.
- The power cord of the FLM R22+ is equipped with a 3-wire grounding plug, a plug having a third (grounding) pin. This plug will only fit into a grounding-type IEC 60309 power outlet. This is a safety feature. Mains power cord with IEC 60309 plug:



Warning: This apparatus must be grounded (earthed) via the supplied 3 conductor AC power cable. If the supplied power cable is not the correct one, consult your dealer.

If you are unable to insert the plug into the outlet, contact your electrician to replace your obsolete outlet with respect to the local regulations. Do not defeat the purpose of the grounding-type plug.

- Do not allow anything to rest on the power cord. Do not locate this product where persons will walk on the cord. To disconnect the cord, pull it out by the plug. Never pull the cord itself.
- If an extension cord is used with this product, make sure that the total of the ampere ratings on the products plugged into the extension cord does not exceed the extension cord ampere rating.
- Use only the power cord supplied with your device. While appearing to be similar, other power cords have not been safety tested at the factory and may not be used to power the device. For a replacement power cord, contact your dealer.
- Never push objects of any kind into this product through cabinet slots as they may touch dangerous voltage points or short out parts that could result in a risk of fire or electrical shock.
- Never spill liquid of any kind on the product. Should any liquid or solid object fall into the cabinet, unplug the set and have it checked by qualified service personnel before resuming operations.
- Lightning - For added protection for this video product during a lightning storm, or when it is left unattended and unused for long periods of time, unplug it from the wall outlet. This will prevent damage to the device due to lightning and AC power-line surges.

To prevent personal injury

- Isolated electrically before re-lamping. Caution : hot lamp (house).
- Caution: High pressure lamp may explode if improperly handled. Refer servicing to qualified service personnel. The customer should never attempt to disassemble the lamp casing or to dispose of the lamp casing other than by returning it to Barco.
- To reduce the lamp heat of the projector, switch the projector first to standby and let the projector lamp cool down for at least 5 minutes. Then the projector may be switched off with the power switch.
- To prevent injury and physical damage, always read this manual and all labels on the system before inserting the lamp casing, connecting to the wall outlet or adjusting the projector.
- To prevent injury, take note of the weight of the projector. Minimum 4 persons are needed to carry the FLM R22+.
- To prevent injury, ensure that the lens and all cover plates are correctly installed. See installation procedures.
- Warning: high intensity light beam. NEVER look into the lens ! High luminance could result in injury to the eye.
- Before attempting to remove any of the projector's covers, you must disconnect from the wall outlet.
- When performing setup work to a ceiling mounted projector, to prevent injury caused by falling objects or the system, set out a keep out area.
- Consult a professional structural engineer prior to suspending the projector from a structure not intended for that use. Always ensure that the working load limit of the structure can handle the load of the projector.
- Never stack more than two (2) FLM projectors in a hanging configuration (truss) and never stack more than three (3) FLM projectors in a base stand configuration (table mount).
- The power input at the projector side is considered as the disconnect device. When required to switch off the device, to access parts inside, always disconnect the power cord at the base of the device. In case the power input at the base of the device is not accessible (e.g. ceiling mount), the socket outlet supplying the device shall be installed nearby the device and be easily accessible, or a readily accessible general disconnect device shall be incorporated in the fixed wiring.
- Do not place this equipment on an unstable cart, stand, or table. The product may fall, causing serious damage to it and possible injury to the user.
- When mounting the device to the ceiling or to a rigging system, always mount security chains.
- It is hazardous to operate without lens or shield. Shields, lenses or ultra-violet screens shall be changed if they have become visible damaged to such an extent that their effectiveness is impaired. For example by cracks or deep scratches.
- **Warning: Protection from ultraviolet radiation:** Do not look directly in the light beam. The lamp contained in this product is an intense source of light and heat. One component of the light emitted from this lamp is ultraviolet light. Potential eye and skin hazards are present when the lamp is energized due to ultraviolet radiation. Avoid unnecessary exposure. Protect yourself and your employees by making them aware of the hazards and how to protect themselves. Protecting the skin can be accomplished by wearing tightly woven garments and gloves. Protecting the eyes from UV can be accomplished by wearing safety glasses that are designed to provide UV protection. In addition to the UV, the visible light from the lamp is intense and should also be considered when choosing protective eye wear.
- **Exposure to UV radiation:** Some medications are known to make individuals extra sensitive to UV radiation. The American Conference of Governmental Industrial Hygienists (ACGIH) recommends occupational UV exposure for an 8-hour day to be less than 0.1 microwatts per square centimeters of effective UV radiation. An evaluation of the workplace is advised to assure employees are not exposed to cumulative radiation levels exceeding these government guidelines.
- **Cooling liquid circuit.** The device head contains a cooling circuit filled with Blue antifreeze diluted (1/3 ethanediol – 2/3 Demi water).
When the cooling circuit leaks, switch off the device and contact a service technician.
The liquid is not for household use. Keep out of reach of children. Harmful by oral intake. Avoid exposure to pregnant women. Avoid contact with eyes, skin and clothing. Avoid inhale of the noxious fumes.

To prevent device damage

- The FLM R22+ has been designed for use with a specific lamp (house) type. See installation instructions for its correct type.
- If the air filters are not regularly replaced, the air flow inside the projector could be disrupted, causing overheating. Overheating may lead to the projector shutting down during operation.
- In order to ensure that correct airflow is maintained, and that the device complies with electromagnetic compatibility (EMC) requirements, and for safety requirements, it should always be operated with all of its covers in place.
- Slots and openings in the cabinet are provided for ventilation. To ensure reliable operation of the product and to protect it from overheating, these openings must not be blocked or covered. The openings should never be blocked by placing the product on a bed, sofa, rug, or other similar surface. This product should never be placed near or over a radiator or heat register. The device should not be placed in a built-in installation or enclosure unless proper ventilation is provided.
- Do not block the projector cooling fans or free air movement under and around the projector. Loose papers or other objects may not be nearer to the projector than 10 cm (4") on any side.
- The device must always be mounted in a manner which ensures free flow of air into its air inlets and unimpeded evacuation of the hot air exhausted from its cooling system. Heat sensitive materials should not be placed in the path of the exhausted air. Leave at least a free safety area of 1 meter (40") at the rear of the projector.
- Ensure that nothing can be spilled on, or dropped inside the projector. If this does happen, switch off and unplug the mains supply immediately. Do not operate the projector again until it has been checked by qualified service technicians.
- Consult a professional structural engineer when you have the intention to use this projector as ceiling mounted projector. Always ensure the working load limit of the structure supporting the projector.
- Do not use this equipment near water.

- **Special Care for Laser Beams:** Special care should be used when DLP projectors are used in the same room as high power laser equipment. Direct or indirect hitting of a laser beam on to the lens can severely damage the Digital Mirror Devices™ in which case there is a loss of warranty.
- Never place a FLM R22+ in direct sun light. Sun light on the lens can severely damage the Digital Mirror Devices™ in which case there is a loss of warranty.
- Save the original packing material; they will come in handy if you ever have to ship your equipment. For maximum protection, repack your set as it was originally packed at the factory.
- Unplug this product from the wall outlet before cleaning. Do not use liquid cleaners or aerosol cleaners. Use a damp cloth for cleaning. Never use strong solvents, such as thinner or benzine, or abrasive cleaners, since these will damage the cabinet. Stubborn stains may be removed with a cloth lightly dampened with mild detergent solution.
- To ensure the highest optical performance and resolution, the projection lenses are specially treated with an anti-reflective coating, therefore, avoid touching the lens. To remove dust on the lens, use a soft dry cloth. Do not use a damp cloth, detergent solution, or thinner.
- Rated maximum ambient temperature, $t_a = 40\text{ }^\circ\text{C}$ (104°F).
- The lamp house shall be replaced if it has become damaged or thermally deformed.

To prevent battery explosion

- Danger of explosion if battery is incorrectly installed.
- Replace only with the same or equivalent type recommended by the manufacturer.
- Dispose of used batteries according to the manufacturer's instruction.

To prevent fire hazard

- Warning "Risk of fire". Do not place flammable or combustible materials near the projector !
This projector radiates heat on its external surfaces and from ventilation ducts during normal operation, which is both normal and safe. Exposing flammable or combustible materials into close proximity of this projector could result in the spontaneous ignition of that material, resulting in a fire. For this reason, it is absolutely necessary to leave an "exclusion zone" around all external surfaces of the projector whereby no flammable or combustible materials are present. The exclusion zone must be not less than 40 cm (18"). The exclusion zone on the lens side must be at least 2 m (80").
- Do not cover the projector or the lens with any material while the projector is in operation.
- Mount the device in a well ventilated area away from sources of ignition and out of direct sun light.
- Never expose the projector to rain or moisture.
- In the event of fire, use sand, CO₂, or dry powder fire extinguishers; never use water on an electrical fire.
- This product should never be placed near or over a radiator or heat register.
- This projector should not be placed in a built-in installation or enclosure unless proper ventilation is provided.
- The operation room must be well ventilated or cooled in order to avoid build up of heat.

On servicing

- Do not attempt to service this product yourself, as opening or removing covers may expose you to dangerous voltage potentials and risk of electric shock.
- Refer all servicing to qualified service personnel.
- Fence off a restricted area of at least 3 meters around the projector using an eye-catching fence and "KEEP OUT" signs. This to prevent unauthorized persons coming near the projector during servicing.
- Unplug this product from the wall outlet and refer servicing to qualified service technicians under the following conditions:
 - When the power cord or plug is damaged or frayed.
 - If liquid has been spilled into the equipment.
 - If the product has been exposed to rain or water.
 - If the product does not operate normally when the operating instructions are followed. Adjust only those controls that are covered by the operating instructions since improper adjustment of the other controls may result in damage and will often require extensive work by a qualified technician to restore the product to normal operation.
 - If the product has been dropped or the cabinet has been damaged.
 - If the product exhibits a distinct change in performance, indicating a need for service.
- Replacement parts: When replacement parts are required, be sure the service technician has used original Barco replacement parts. Unauthorized substitutions may result in degraded performance and reliability, fire, electric shock or other hazards. Unauthorized substitutions may void warranty.
- Safety check: Upon completion of any service or repairs to this device, ask the service technician to perform safety checks to determine that the product is in proper operating condition.
- Lamp replacement: high pressure lamp may explode if improperly handled.

1.3 Important warnings concerning FLM flight cases

Important warnings concerning stacking/transporting FLM rental flight cases

- Stack maximum two (2) FLM rental flight cases high. Never higher.
- Surface on which flight case is standing must be level to ensure that the total load is evenly spread out among the four wheels. The surface must also be able to support the load safely.
- Before stacking or transporting flight cases, check the wheels and their fixation screws for wear or defects.
- Before stacking or transporting flight cases, check that the four lock handles on each flight case are in good working order and locked securely.
- When stacked, make sure the wheels of the upper flight case are precisely positioned in the stacking dishes of the flight case below.
- Stacked flight cases may not be moved. Before stacking, the lower flight case must already be in its final resting position before placing the second upon it.
- Never stack loaded flight cases in a truck or other transport medium, unless each flight case is rigidly strapped tight.
- In the event of a wheel breaking, flight cases must be rigidly strapped tight to prevent a stack collapsing.
- Use an appropriate forklift to raise flight cases and take the necessary precautions to avoid personnel injury.

2. GENERAL

About this chapter

Read this chapter before installing your FLM R22+. It contains important information concerning installation requirements for the FLM R22+, such as minimum and maximum allowed ambient temperature, humidity conditions, required safety area around the installed projector, required power net, compatible signal sources, etc.

Furthermore, careful consideration of things such as image size, ambient light level, projector placement and type of screen to use are critical to the optimum use of the projection system.

Overview

- Installation requirements
- Unpacking the projector
- Box content
- FLM flight case
- Projector configurations
- Projector air inlets and outlets
- Free download of Projector Toolset

2.1 Installation requirements

Ambient temperature conditions

The maximum allowed ambient temperature for an operating Barco FLM R22+ may not exceed +40 °C (+104 °F).

The minimum allowed ambient temperature for an operating Barco FLM R22+ may not drop below +10 °C (+50 °F).

The projector will not operate if the ambient air temperature falls outside this range (+10 °C → +40 °C or +50 °F → +104 °F). Be aware that room heat rises to the ceiling. Check if the temperature near the installation site is not excessive.

The minimum storage temperature is -35 °C (-31 °F) and the maximum storage temperature is +65 °C (+149 °F).

Humidity conditions

Storage: 0 to 98% relative humidity, non-condensing.

Operation: 0 to 95% relative humidity, non-condensing.

Projector weight

Do not underestimate the weight of one Barco FLM R22+, which is about ±100 kg (±225 lb.). Be sure that the table or truss installation on which the projector(s) has to be installed is capable of handling five (5) times the complete load of the complete system.

Power requirements

One Barco FLM R22+ requires 200-240 VAC, 50–60 Hz, 18 amps at 230 VAC.

Clean air environment

A projector must always be mounted in a manner which ensures the free flow of clean air into the projectors ventilation inlets. For installations in environments where the projector is subject to airborne contaminants such as that produced by smoke machines or similar (these deposit a thin layer of greasy residue upon the projectors internal optics and imaging electronic surfaces, degrading performance), then it is highly advisable and desirable to have this contamination removed prior to it reaching the projectors clean air supply. Devices or structures to extract or shield contaminated air well away from the projector are a prerequisite, if this is not a feasible solution then measures to relocate the projector to a clean air environment should be considered.

Only ever use the manufacturer's recommended cleaning kit which has been specifically designed for cleaning optical parts, never use industrial strength cleaners on the projector's optics as these will degrade optical coatings and damage sensitive optoelectronics components. Failure to take suitable precautions to protect the projector from the effects of persistent and prolonged air contaminants will culminate in extensive and irreversible ingrained optical damage. At this stage cleaning of the internal optical units will be noneffective and impracticable. Damage of this nature is under no circumstances covered under the manufacturer's warranty and may deem the warranty null and void. In such a case the client shall be held solely responsible for all costs incurred during any repair. It is the clients responsibility to ensure at all times that the projector is protected from the harmful effects of hostile airborne particles in the environment of the projector. The manufacturer reserves the right to refuse repair if a projector has been subject to knowingly neglect, abandon or improper use.

Which screen type ?

There are two major categories of screens used for projection equipment. Those used for front projected images and those for rear projection applications.

2. General

Screens are rated by how much light they reflect (or transmit in the case of rear projection systems) given a determined amount of light projected toward them. The 'GAIN' of a screen is the term used. Front and rear screens are both rated in terms of gain. The gain of screens range from a white matte screen with a gain of 1 (x 1) to a brushed aluminized screen with a gain of 10 (x 10) or more. The choice between higher and lower gain screens is largely a matter of personal preference and another consideration called the viewing angle. In considering the type of screen to choose, determine where the viewers will be located and go for the highest gain screen possible. A high gain screen will provide a brighter picture but reduce the viewing angle. For more information about screens, contact your local screen supplier.

What image size? How big should the image be?

The projector is designed for projecting an image size : minimum 1 meter (3.3 ft.) to maximum 18 meter (59 ft.) (depending on the ambient light conditions), with an aspect ratio of 4 to 3 (recommended between 1 m (3.3ft) - 12 m (39.4ft)).

2.2 Unpacking the projector

What has to be done ?

At delivery the projector is packed in a carton box upon a wooden pallet and secured with banding and fastening clips. Furthermore, to provide protection during transportation, the projector is surrounded with foam. Once the projector is arrived at the installation site, it has to be removed from the carton box and wooden pallet in a safe manner without damaging the projector.

Necessary tools

- Side cutter.
- 8 mm Allen key.

How to unpack the projector ?

1. Remove the banding around the carton box, by releasing the fastening clips as illustrated, and remove the top cover.

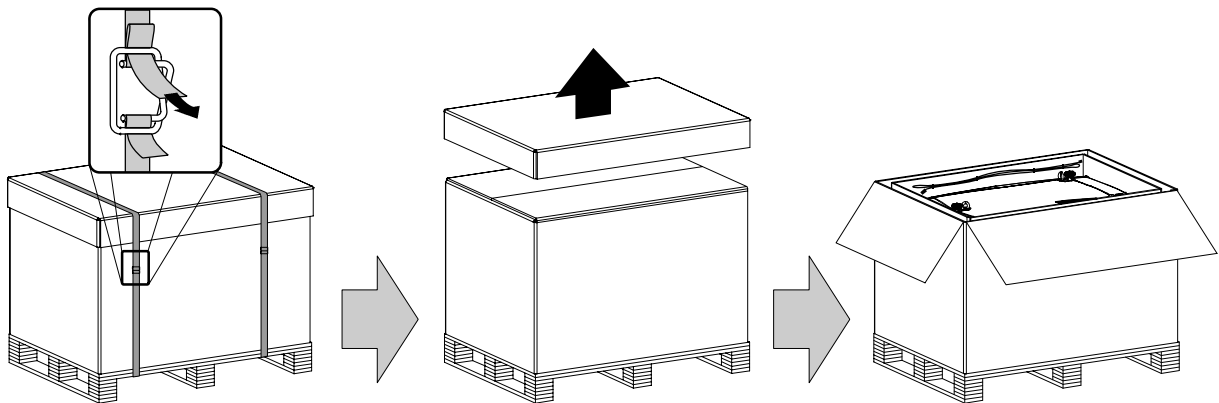

Image 2-1

2. Remove the power cord, which is attached to the packaging with a cable ties, and the two smaller carton boxes, located between the inner carton sleeve and outer carton box.

Note: The two smaller carton boxes contain the manuals, the remote control unit (RCU), two standard batteries size AA and four rigging clamps for projector suspension.

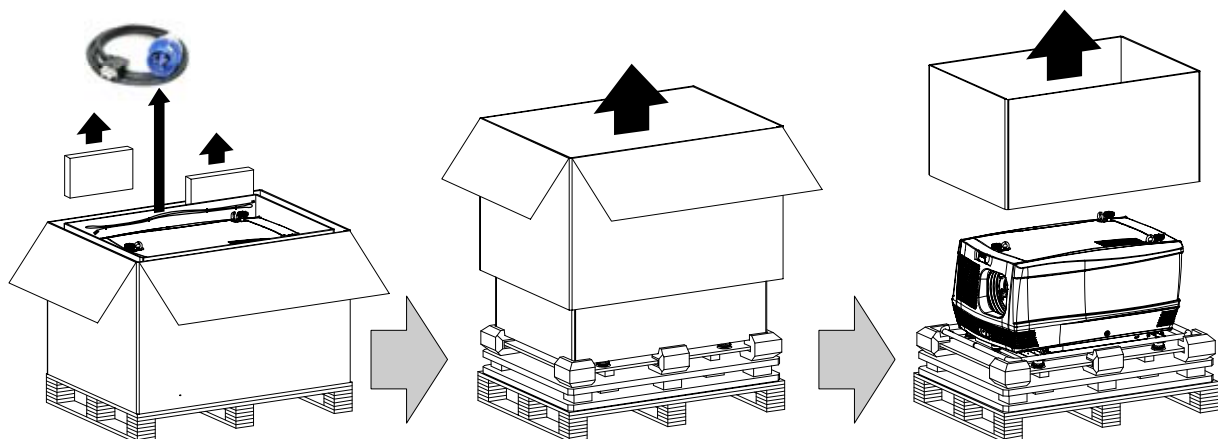

Image 2-2

- Remove the carton box, the inner carton sleeve and the foam around the projector. See image 2-2.

Note: The projector is still attached to a wooden plate, which is detached from the below pallet.

- Gently turn the projector upside down to gain access to the four bolts, which secure the projector. Note that this wooden plate is detached from the pallet.

Tip: Lay a blanket (or the earlier removed foam) on the floor to protect the projector housing from scratches while turning.

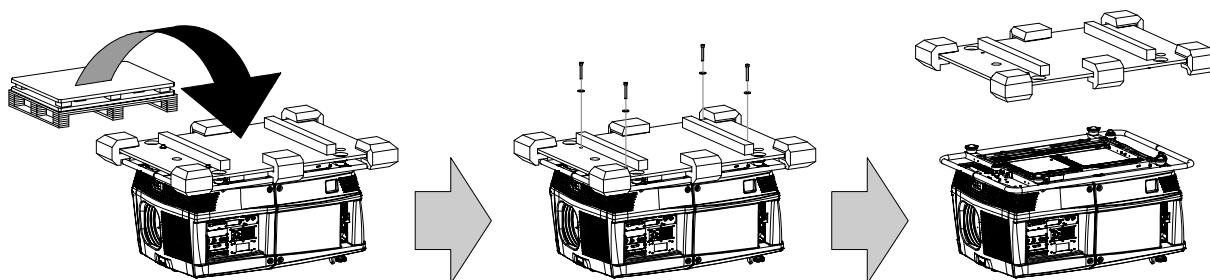

Image 2-3

- Remove the wooden plate from the projector bottom, by releasing the four bolts. Use an 8 mm Allen key. See image 2-3.
- Gently turn the projector back on its feet.
- Remove the foam rubber around the carrying handle.



Save the original shipping carton and packing material, they will be necessary if you ever have to ship your projector. For maximum protection, repack your projector as it was originally packed at the factory.



A rubber foam inside a plastic bag is placed into the lens opening of the projector. It's recommended to reuse this foam and plastic back each time you transport the projector. This to prevent intrusion of dust and foreign particles.

2.3 Box content

Content

- One Barco FLM R22+, weight ± 100 kg (± 225 lb.).
- One Remote Control Unit (RCU).
- Two AA size batteries for the RCU.
- One power cord of 2,5 meter with EN60-309 plug.
- Four rigging clamps for projector suspension.
- One user manual.

Initial inspection

Before shipment, the projector was inspected and found to be free of mechanical and electrical defects. As soon as the projector is unpacked, inspect for any damage that may have occurred in transit. Save all packing material until the inspection is completed. If damaged is found, file claim with carrier immediately. The Barco sales and service office should be notified as soon as possible.



The packaging of the FLM R22+ is provided with a shock-watch label. If this shock-watch label was triggered (red colored at arrival) during transport, indicates that the package was possibly roughly handled by the transport company. In this case, the instructions mentioned on the label, should be followed, which are: adding a note on the "bill of lading" and informing the transport company and the Barco sales and service office as soon as possible.

Mechanical check

This check should confirm that there are no broken knobs or connectors, that the cabinet and panel surfaces are free of dents and scratches, and that the meter face and operating panel are not scratched or cracked. The Barco sales and service office should be notified as soon as possible.

2.4 FLM flight case

Introduction of the FLM flight case

The FLM flight case is designed to transport the FLM R22+ in a safe and secure manner. The four caster wheels, provided with breaks, and the eight handles make the FLM flight case easy to handle. The floor of the flight case wagon is equipped with two small covered compartments to store the remote control and the rigging clamps. Furthermore, three Velcro strips are attached to the bottom for fastening the power cord of the projector.

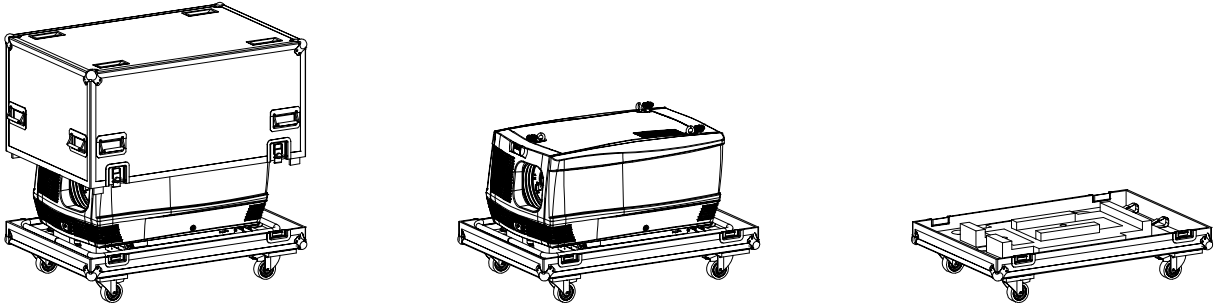

Image 2-4
FLM flight case (R9854510).

The dimensions of the FLM flight case are optimal for maximum utilization of the floor area of a truck. The cover of the FLM flight case has four stacking dishes, which allows to stack the flight cases.

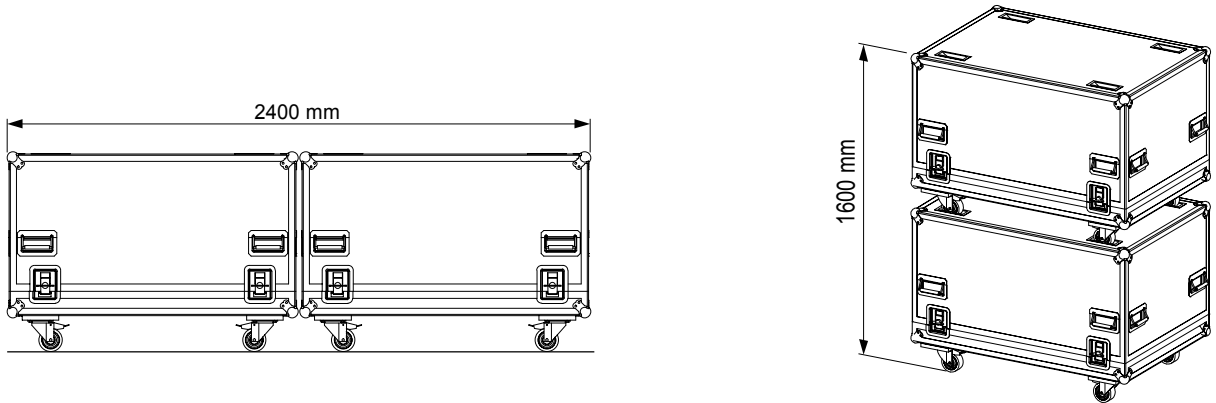

Image 2-5



WARNING: Maximum stack two (2) FLM flight cases high. Never higher.



CAUTION: Prior to inserting projector in flight case turn in the adjustable feet and interlocking adapters fully.

2.5 Projector configurations

The different configurations

Depending on the installation the projector can be mounted in different ways, the 4 different configurations are:

1. Front / Table (F/T)
2. Front / Ceiling (F/C)
3. Rear / Table (R/T)
4. Rear / Ceiling (R/C)

Front projection

The projector is installed, either in a table mount or ceiling mount configuration, at the same side of the screen as the audience.

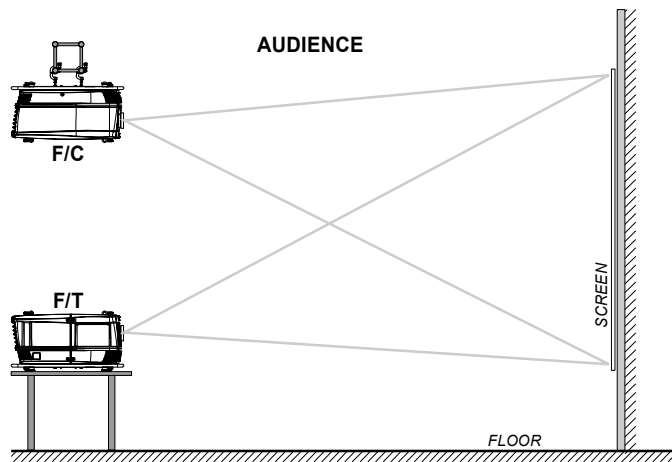

Image 2-6

Rear projection

The projector is installed, either in a table mount or ceiling mount configuration, at the other side of the screen opposite the audience.

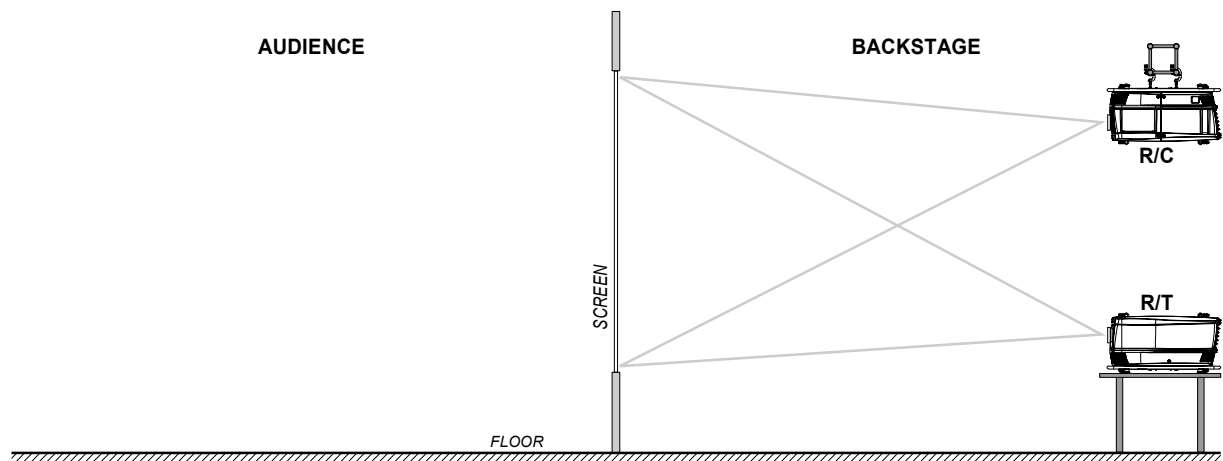

Image 2-7

Positioning the projector

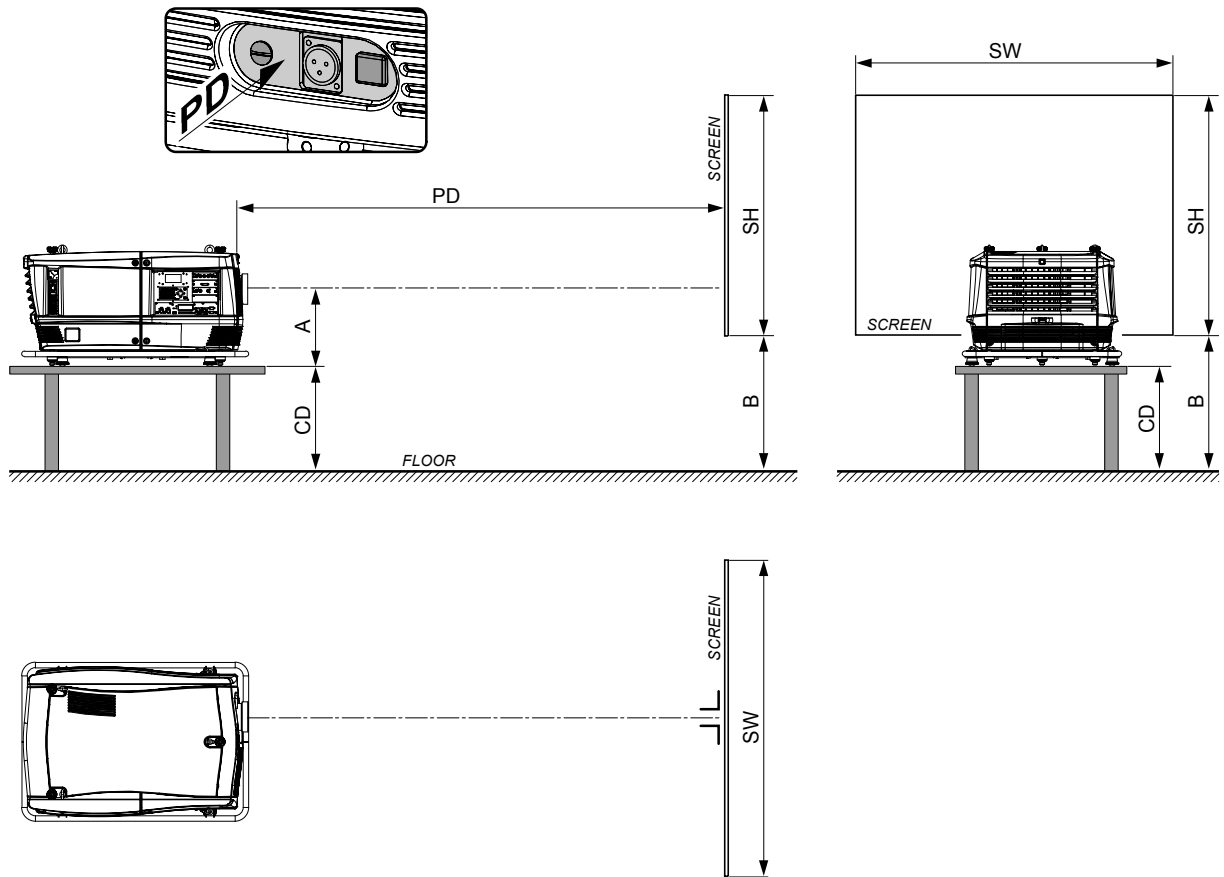

Image 2-8

The projector should be installed at right angles (horizontally and vertically) to the screen at a distance PD . Note the distance (A) between lens centre and table surface is slightly variable. This distance (A) is nominal 35 cm in case all feet are turned in completely and the vertical lens shift is set to zero (0).

On-Axis / Off-Axis projection

The position of the projector with reference to the screen may also be different depending on the installation. Basically the projector can be positioned in On-Axis or Off-Axis configuration. On-Axis configuration means that the projector is positioned so as to have the centre of the lens coinciding with the centre of the screen. Off-Axis projection is obtained by shifting the lens up, down, left or right. Several parameters can be calculated determining the position in any installation.

Formula to calculate the distance CD for On-Axis projection: $CD = SH/2 + B - A$

Shift range

The lens can be shifted with respect to the DMD (P) which result in a shifted image on the screen (Off-Axis). A 100% shift means that the centre point of the projected image is shifted by half the screen size. In other words, the centre point of the projected image falls together with the outline of the image in an On-Axis projection. Due to mechanical and optical limitations it's recommended to keep the shift values within the field of view (F) as illustrated below. Within these shift ranges the projector and lens perform excellently. Configuring the projector outside these shift ranges will result in a slight decline of image quality.

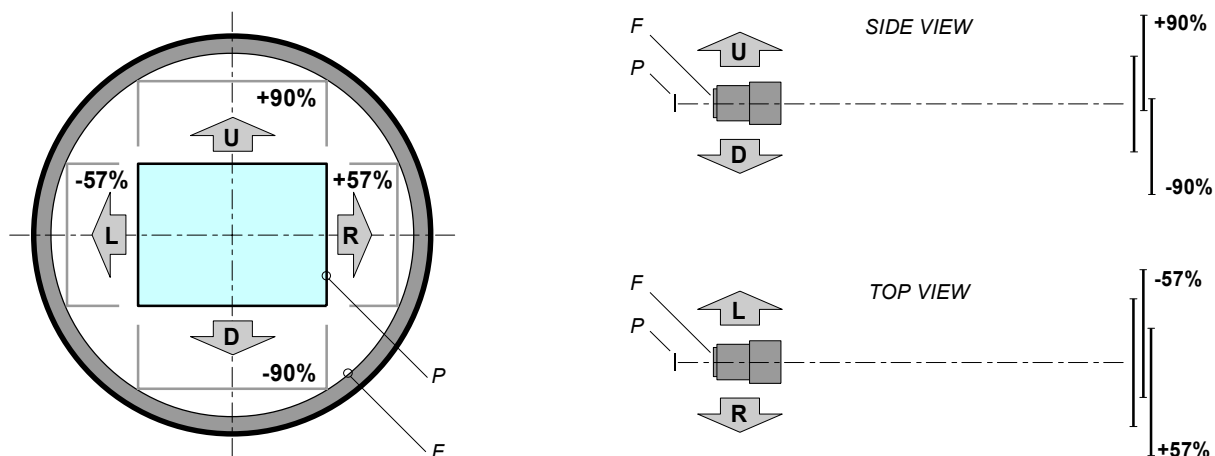

Image 2-9
 P DMD.
 F Field of view.



It's mechanical possible to shift outside the recommended field of view ($\pm 100\%$ UP/DOWN and $\pm 70\%$ LEFT/RIGHT), but this will result in a slightly decline of image quality depending on the used lens and the zoom position of the used lens. Furthermore, shifting too much in both directions will result in a blurred image corner.



Best image quality is projected in the On-Axis configuration.

Horizontal and vertical projector tilt ranges

The projector can be rotated and mounted at any vertical angle. In other words, you can tilt the lens side of the projector as much as desired for your application. Side to side tilt, however, must not exceed $\pm 15^\circ$. This limit ensures that the lamp in the projector operates properly and safely. More tilting within area C is allowed but lamp flicker can happen.

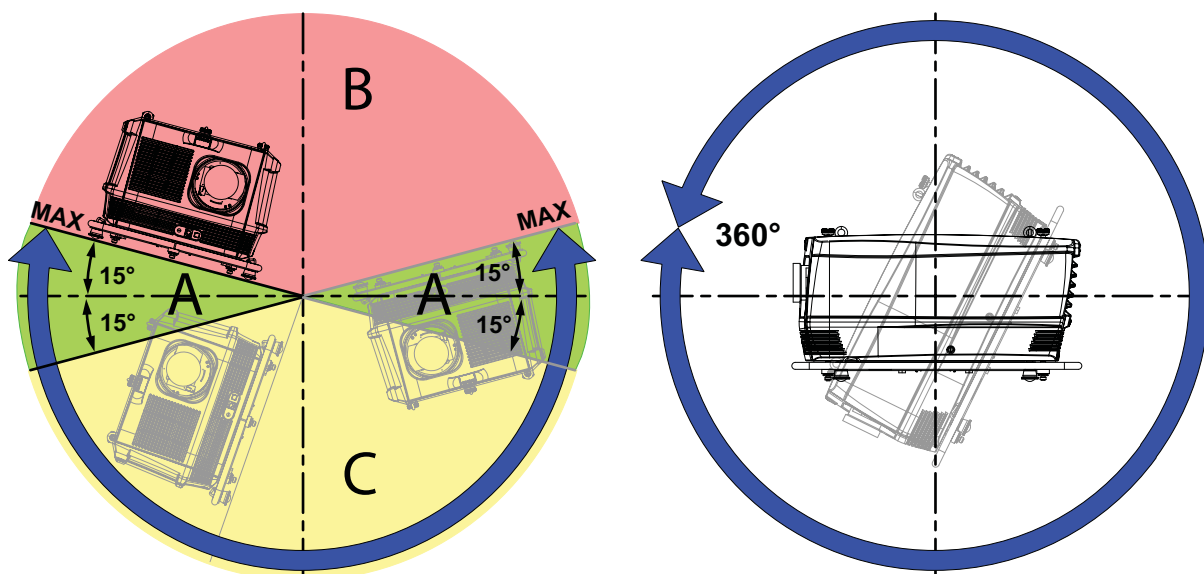

Image 2-10
 A Tilting allowed without problems
 B No tilting allowed in this area
 C Tilting allowed but lamp flicker possible



CAUTION: Always respect the allowed tilt range of the projector. Neglecting this will result in lamp flicker, which reduces the light output and the life span of the lamp substantially. Furthermore, in the long term, the possibility exist that the lamp explodes.

2.6 Projector air inlets and outlets

Air inlets and outlets

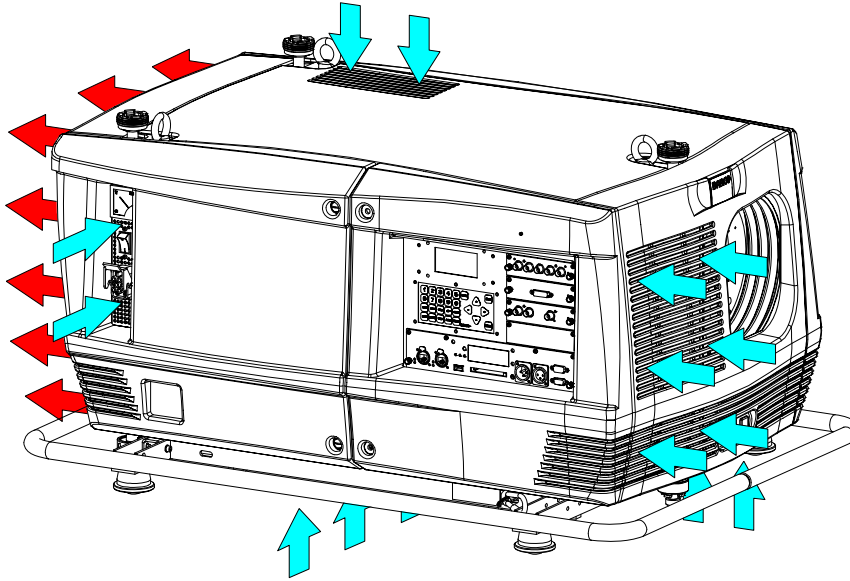

Image 2-11

The FLM R22+ has 5 air inlet channels and one air outlet. The air outlet is located at the rear of the projector. The air inlets are located at the front, bottom, top and right side of the projector.

2.7 Free download of Projector Toolset

About Projector Toolset

Projector Toolset is a software tool to set up, configure, manage and control Barco projectors.

The concept of this Projector Toolset software is modular. The basic package can be extended with several optional device plug-in modules, now and in the future available.

The Projector Toolset software works with configurations that can be loaded. Within a configuration, different snapshots can be taken. A snapshot represents a current state of a configuration and can be reloaded to return to this typical state. These terms will be used through the complete software.

Projector Toolset is a stand-alone application that runs on a Java Virtual Machine and that does not require extra services to run.

Several configurations can be controlled simultaneously. Even when the configurations are connected via different ways.



Projector Toolset is only available in a download version, no CD can be ordered.

Where to find the download file(s)

The program and all necessary plug-ins, as well as the Reference manual can be downloaded for free from Barco's Partnerzone, URL <https://my.barco.com>. Registration is necessary.

If you are not yet registered, click on Partnerzone registration and follow the instructions. With the created login and password, it is possible to enter the partnerzone where you can download the Projector Toolset software and the device plug-in updates as well as the corresponding reference manual.

When downloading the complete Projector Toolset, this software contains already the latest device plug-ins. When you already have the latest core version of Projector Toolset, it is possible to download only device plug-in updates from the same web site location.

As Projector Toolset is a stand alone application, it is not necessary to install any other software. A Java virtual machine is included with this download.

Installation

Download first the reference manual (Part number: R59770052) and follow the installation instructions as written in this manual.

3. PHYSICAL INSTALLATION

About this chapter

This chapter explains how to install and set up your FLM projector. If you are familiar with the projector and want to quickly set it up for temporary use, follow the "Quick setup" instructions below. For a more complete setup, follow the instructions and guides covered in the remaining subsections.

Quick setup

The following steps describe briefly how to setup your FLM projector in a table mount front projection. Note that each step refers to a corresponding procedure, which is more detailed and illustrated.

1. Install the batteries of the remote control, see "RCU battery installation", page 20.
2. Place the projector on a solid table in front of the screen at the expected throw distance. Ensure that the projector is installed at right angles (horizontally and vertically) with the screen.
3. Select and install an appropriate lens, which covers the throw ratio (= screen size / projector screen distance). For more details see "Lens selection", page 23, and "Lens installation", page 24.
4. Connect the projector with the local power net, see "Power connection", page 35.
5. Connect your source to the appropriate input module, see "Input source connections", page 37.
6. Switch ON the projector, see procedure "Switching on", page 45.
7. Select the input slot at which your source is connected with. Do this by pressing the numeric key "1", "2", "3" or "4" on the remote control unit or on the local keypad, see chapter "Source selection", page 53.
8. Zoom and shift the lens until the image is properly projected on the screen, Do this by using the "ZOOM" and "FOCUS" key on the remote control unit or on the local keypad, see "Quick Lens Adjustment via LENS key", page 49 or "Direct Lens Adjustment (RCU)", page 50. If necessary, level the projector from side to side by turning the adjustable feet in or out, see "Alignment of a table mount FLM projector", page 27.

3.1 Remote control unit (RCU)

Introduction

The remote control unit (A) of the FLM projector is equipped with a rugged case (B) and an XLR adaptor (C). The remote control unit can be used wired via mini-jack or via rugged XLR. Note that the backlight, of the remote control unit, illuminate continuously when wire connected.

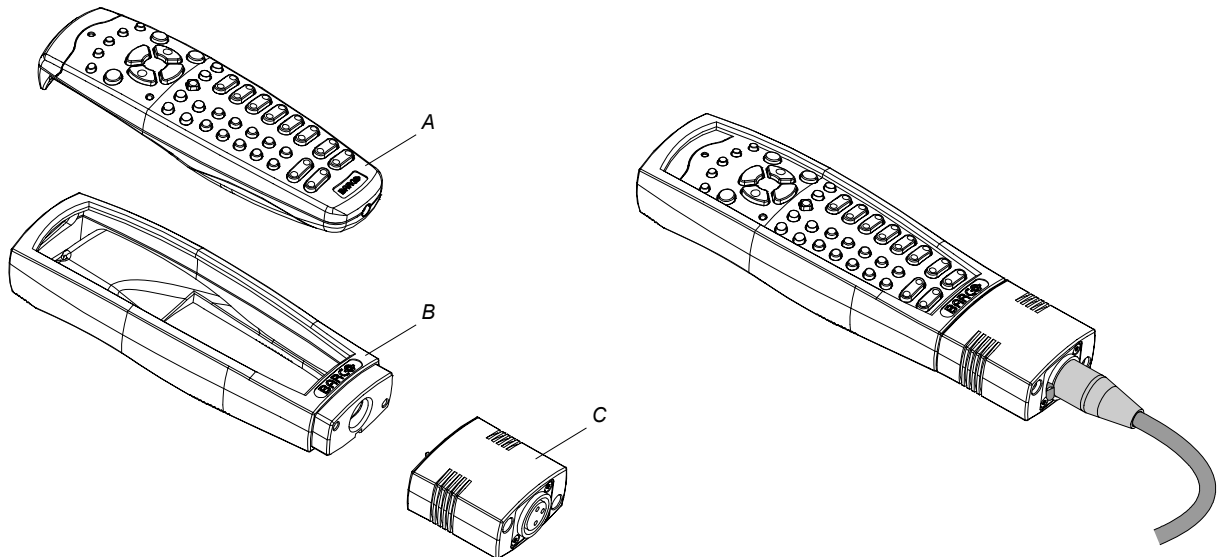

Image 3-1

- A Remote control unit (RCU).
- B Rugged case.
- C XLR adaptor.

Overview

- RCU battery installation
- RCU rugged case installation
- RCU XLR adaptor installation
- Using the XLR adaptor of the RCU
- RCU usage possibilities

3.1.1 RCU battery installation

Where to find the batteries for the remote control ?

The batteries are not placed in the remote control unit to avoid control operation in its package, resulting in a shorter battery life time. At delivery the batteries can be found in a separated bag attached to the remote control unit. Before using your remote control, install the batteries first.

How to install the batteries in the remote control ?

1. Push the battery cover tab with the fingernail a little backwards (1) and pull, at the same time, the cover upwards (2).

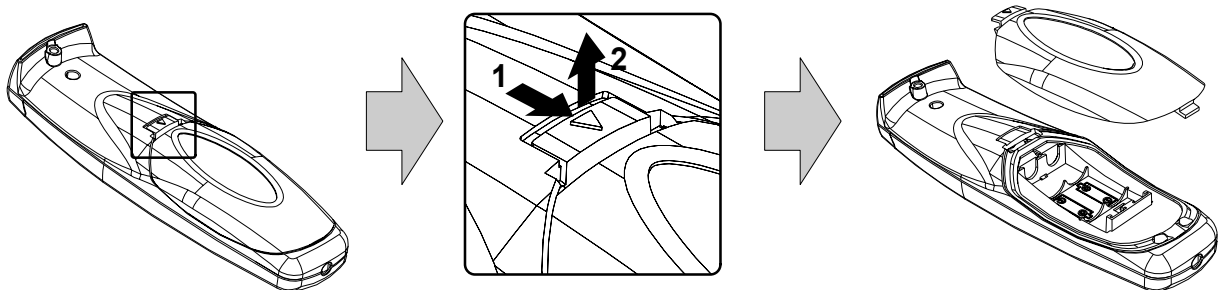

Image 3-2

2. Insert the two AA size batteries, making sure the polarities match the + and - marks inside the battery compartment.

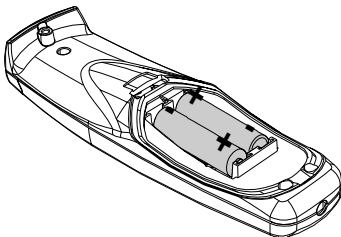

Image 3-3

3. Insert (1) the lower tab of the battery cover in the gap at the bottom of the remote control, and press (2) the cover until it clicks in place.

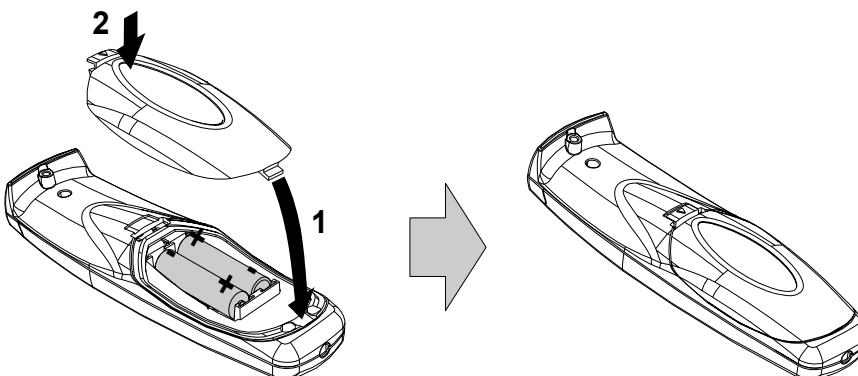

Image 3-4

To prevent battery explosion

- Danger of explosion if battery is incorrectly installed.
- Replace only with the same or equivalent type recommended by the manufacturer.
- Disposal of used batteries must be done according to the manufacturer's instruction.

3.1.2 RCU rugged case installation

How to install the rugged case of the remote control ?

1. Slide the bottom of the RCU into the rugged case and then pull the top of the rugged case over the top of the RCU as illustrated.

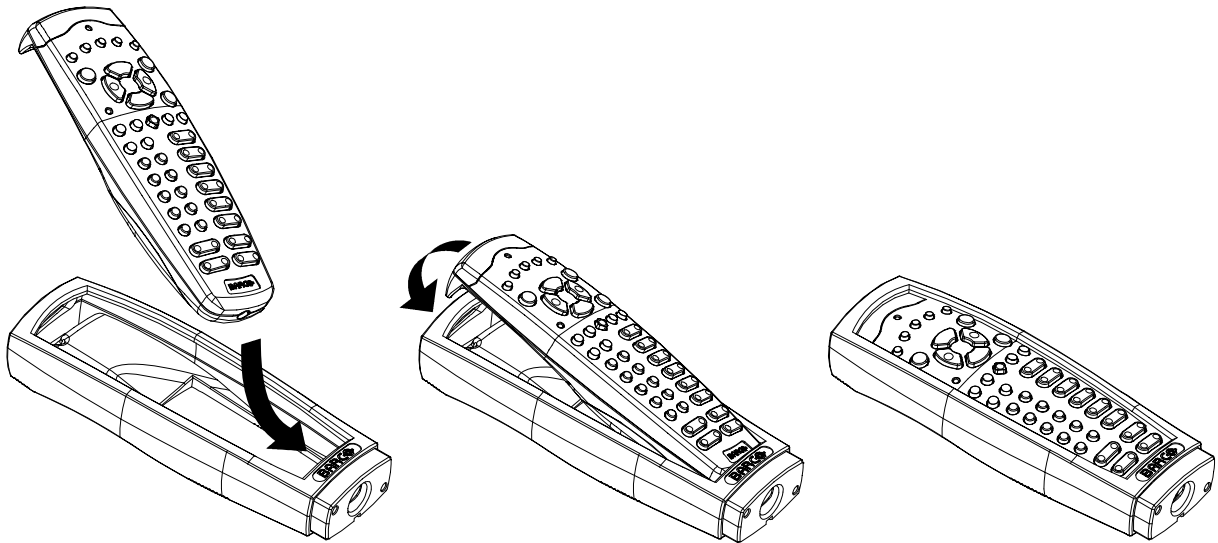

Image 3-5

3.1.3 RCU XLR adaptor installation



Install the rugged case before installing the XLR adaptor. Vice-versa, remove the XLR adaptor before removing the rugged case from the RCU.

Necessary tools

5 mm flat screw driver.

How to install the XLR adaptor of the remote control unit ?

1. Push the XLR adaptor (C) upon the rugged case of the remote control unit as illustrated.

Note: Ensure that the text of the XLR adaptor is on top.

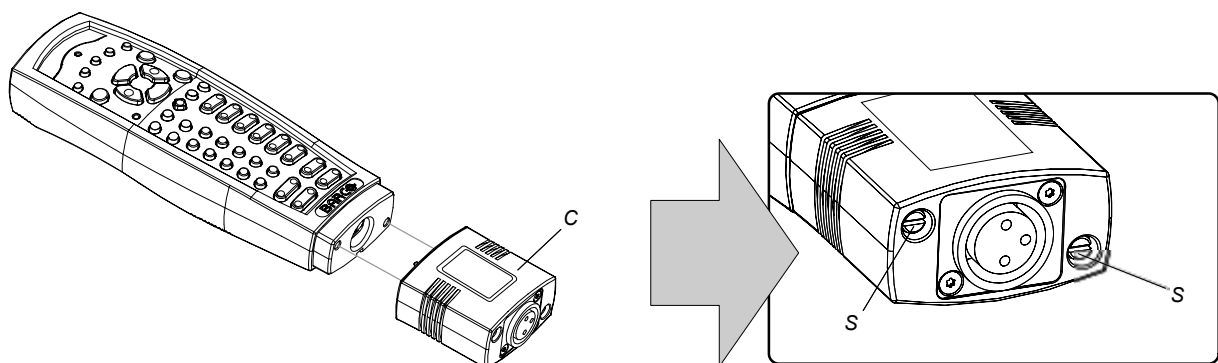

Image 3-6

2. Fasten the two screws (S) of the XLR adaptor. Turn each screw repeatedly one or two turns until both screws are tight.

3.1.4 Using the XLR adaptor of the RCU

How to use the XLR adaptor of the remote control unit ?

1. Connect a cable with XLR plug into the XLR adaptor.
2. Connect the other end of the cable with your FLM R22+.
3. Push the XLR adaptor completely against the rugged case of the remote control unit, as illustrated in the left image below, for wired communication. Pull out the XLR adaptor (about 8 mm) to switch over to wireless communication.

3. Physical installation

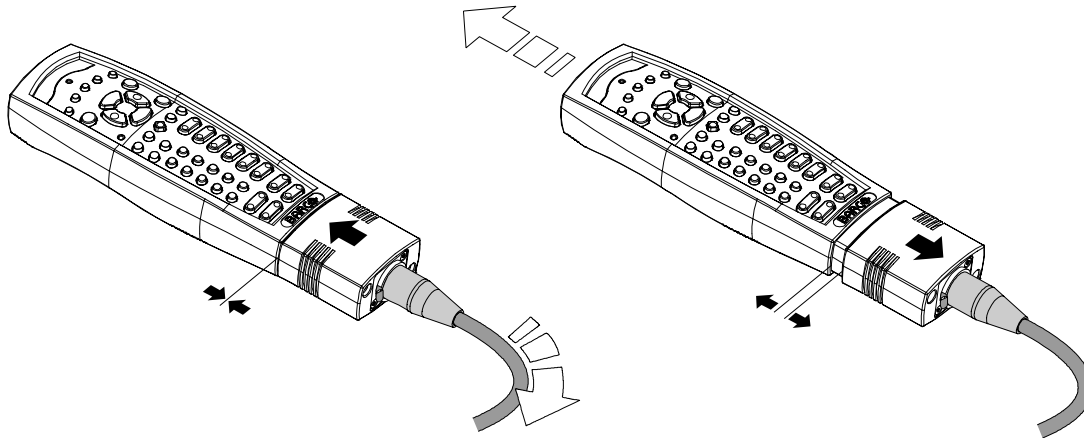

Image 3-7

3.1.5 RCU usage possibilities

Summarized possibilities

Ref.	Possibility description	Comment
a.	RCU not wired	
b.	RCU wired (mini-jack)	Backlight illuminates continuously when wire is connected. Infra red disabled.
c.	RCU with rugged case not wired	
d.	RCU with rugged case wired (mini-jack)	Backlight illuminates continuously when wire is connected. Infra red disabled.
e.	RCU with rugged case and XLR adaptor pulled out "REMOTE" and not wired	The XLR adaptor must be in the pulled out position "REMOTE", otherwise the RCU will not function.
f.	RCU with rugged case and XLR adaptor pulled out "REMOTE" and wired	The RCU will send the commands via infra red to the projector.
g.	RCU with rugged case and XLR adaptor pushed in "WIRED" and wired	The RCU will send the commands via the cable connected with the XLR adaptor to the projector. Backlight illuminates continuously when wire is connected. Infra red disabled.

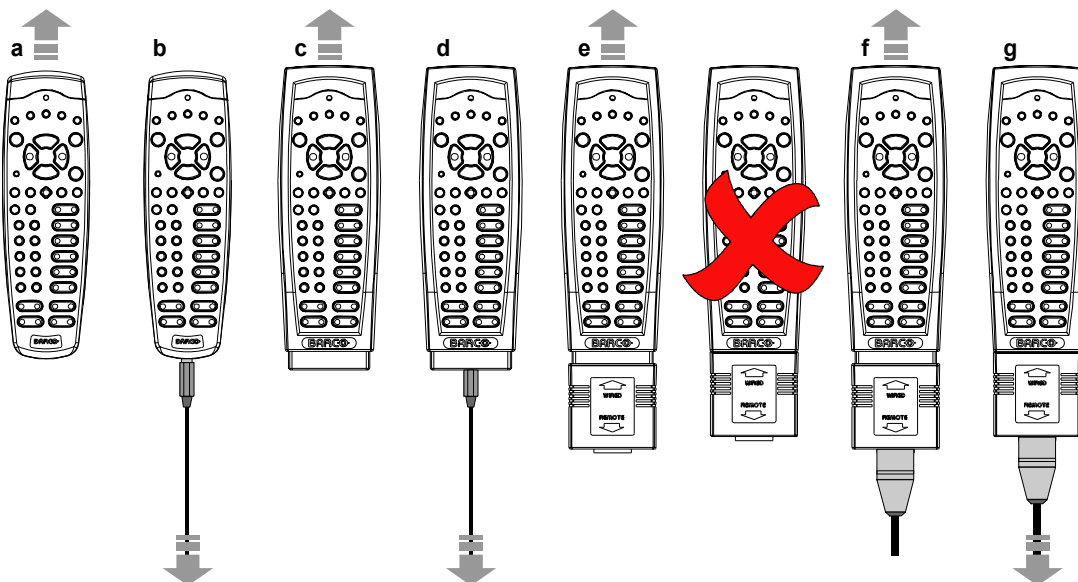

Image 3-8

3.2 Lenses

3.2.1 Available lenses

Available lenses for the FLM R22+ projector

The TLD HB (High Brightness) lens series can be used on the FLM R22+ projector.



Image 3-9
R9842040: TLD HB fixed lens (0.8 : 1)



Image 3-10
R9840770: TLD fixed lens (1.2 : 1)



Image 3-11
R9840775: TLD+ (1.2 : 1) fixed lens



Image 3-12
R9842060: TLD HB zoom lens (1.6 - 2.0 : 1)



Image 3-13
R9842080: TLD HB zoom lens (2.0 - 2.8 : 1)



Image 3-14
R9842100: TLD HB zoom lens (2.8 - 5.0 : 1)



Image 3-15
R9842120: TLD HB zoom lens (5.0 - 8.0 : 1)

3.2.2 Lens selection

How to select the right lens for your application ?

1. Determine the required screen width (SW).
2. Determine the position of the projector in the projection room with regard to the screen and measure the projector-screen distance (PD).

3. Physical installation

- Use the lens formulas to find the best corresponding PD with regard to the measured projector-screen distance for the required screen width SW.

Tip: Divide PD by SW to determine the approximate throw ratio. Choose a Lens, which captures the calculated throw ratio. Use the lens formula of the chosen Lens to recalculate exactly.

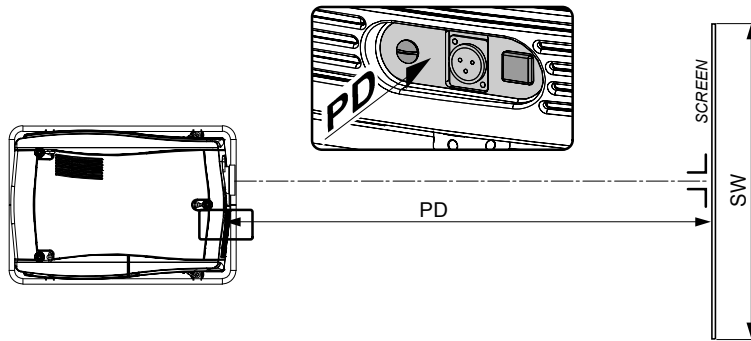

Image 3-16

3.2.3 Lens formulas

Formulas

Lens	Throw ratio for FLM HD	Metric formulas (meter)	Inch formulas (inch)
TLD HB (0.8 : 1)	0.7	$PD = (0.71 \times SW) + 0.05$	$PD = (0.71 \times SW) + 1.97$
TLD (1.2 : 1)	1.1	$PD = (1.03 \times SW) - 0.01$	$PD = (1.03 \times SW) - 0.39$
TLD+(1.2:1)	1.2	$PD = (1.14 \times SW) + 0.11$	$PD = (1.14 \times SW) + 4.33$
TLD HB (1.6 – 2.0 : 1)	1.35 – 1.70	$PD_{min} = (1.36 \times SW) - 0.09$ $PD_{max} = (1.71 \times SW) - 0.13$	$PD_{min} = (1.36 \times SW) - 3.54$ $PD_{max} = (1.71 \times SW) - 5.12$
TLD HB (2.0 – 2.8 : 1)	1.70 – 2.42	$PD_{min} = (1.71 \times SW) - 0.17$ $PD_{max} = (2.42 \times SW) - 0.24$	$PD_{min} = (1.71 \times SW) - 6.69$ $PD_{max} = (2.42 \times SW) - 9.45$
TLD HB (2.8 – 5.0 : 1)	2.42 – 4.35	$PD_{min} = (2.38 \times SW) - 0.16$ $PD_{max} = (4.35 \times SW) - 0.38$	$PD_{min} = (2.38 \times SW) - 6.30$ $PD_{max} = (4.35 \times SW) - 14.96$
TLD HB (5.0 – 8.0 : 1)	4.35 – 6.95	$PD_{min} = (4.17 \times SW) - 0.01$ $PD_{max} = (6.95 \times SW) - 0.29$	$PD_{min} = (4.17 \times SW) - 0.39$ $PD_{max} = (6.95 \times SW) - 11.42$
TLD+(7.5 – 11.2 : 1)	6.93 - 10.34	$PD_{min} = (6.93 \times SW) - 0.2$ $PD_{max} = (10.34 \times SW) - 0.32$	$PD_{min} = (6.93 \times SW) - 7.88$ $PD_{max} = (10.34 \times SW) - 12.60$

3.2.4 Lens installation

How to install a lens into the projector lens holder ?

- Remove the foam rubber in the opening of the lens holder if not removed yet.
- Take the lens assembly out of its packing material and remove the lens caps on both sides.
- Place the lens holder in the "unlocked" position by moving the lens lock handle (A) towards the lens power supply socket (B) as illustrated.

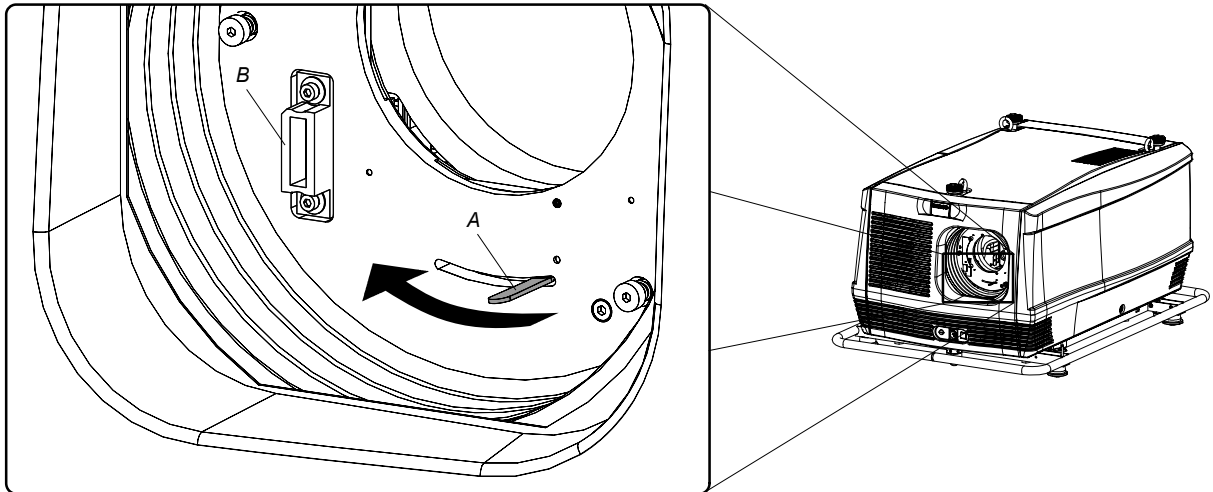

Image 3-17

4. Ensure that the lens holder stands in the On-Axis position (horizontal and vertical mid position).
Note: *The lens holder is placed default in the On-Axis position at factory.*
5. Gently insert the lens in such a way that the lens connector matches the socket (B).

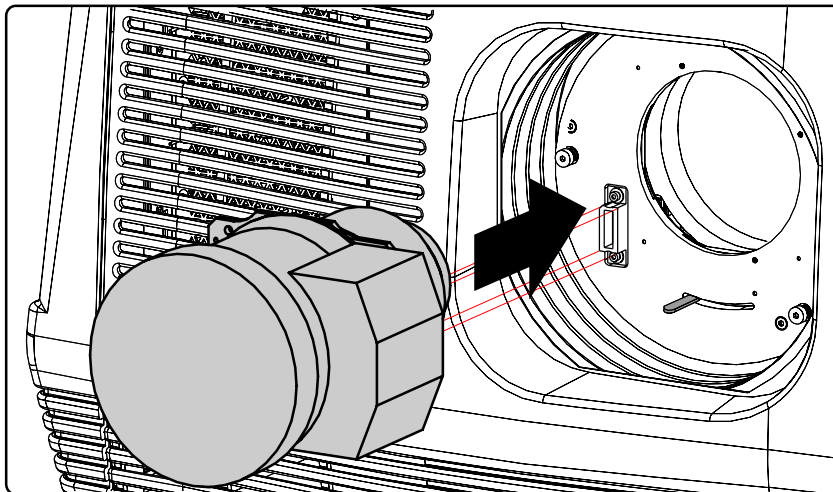

Image 3-18

6. Insert the lens until the connector seats into the socket.
Warning: *Do not release the Lens yet, as the Lens may fall out of the Lens Holder.*
7. Secure the lens in the lens holder by sliding the lens lock handle into the "locked" position, which is away from the lens power supply socket. Ensure the lens touches the front plate of the lens holder.

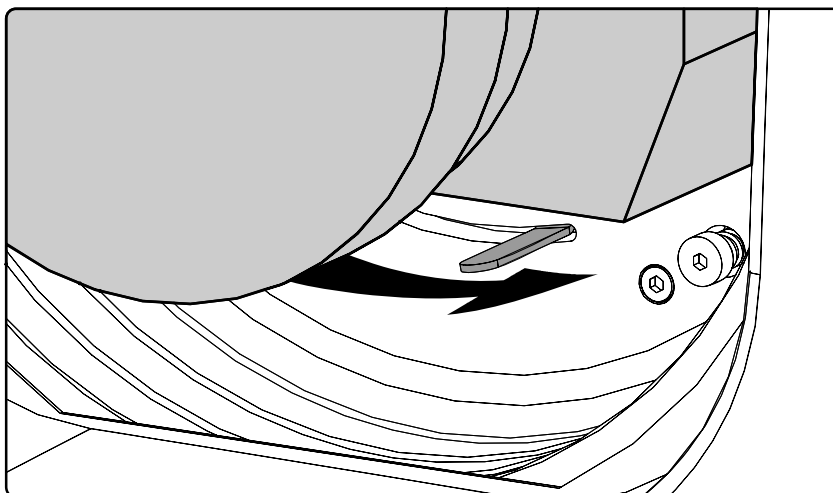

Image 3-19

8. Check if the lens is really secured by trying to pull the lens out of the lens holder.



CAUTION: Never transport the projector with a Lens mounted in the Lens Holder. Always remove the Lens before transporting the projector. Neglecting this can damage the Lens Holder and Prism.

3.2.5 Lens removal

How to remove a lens from the projector lens holder ?

1. Support the lens with one hand while you unlock the lens holder by sliding the lock handle towards the “unlocked” position as illustrated.

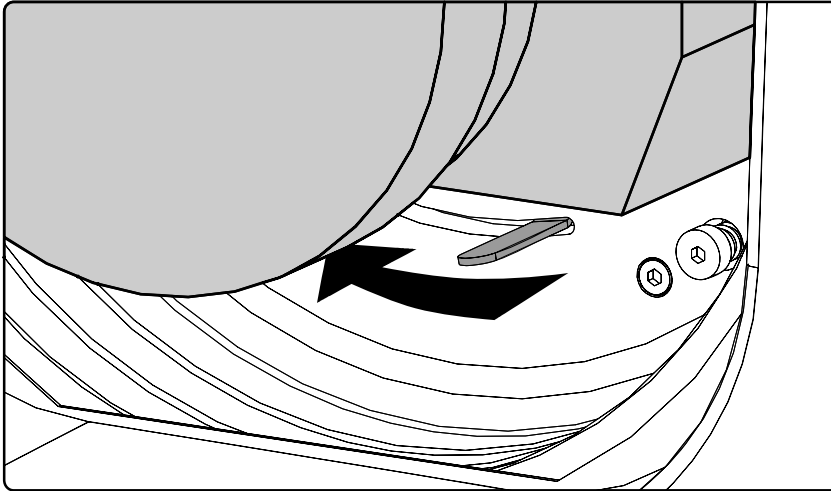

Image 3-20

2. Gently pull the lens out of the lens holder.

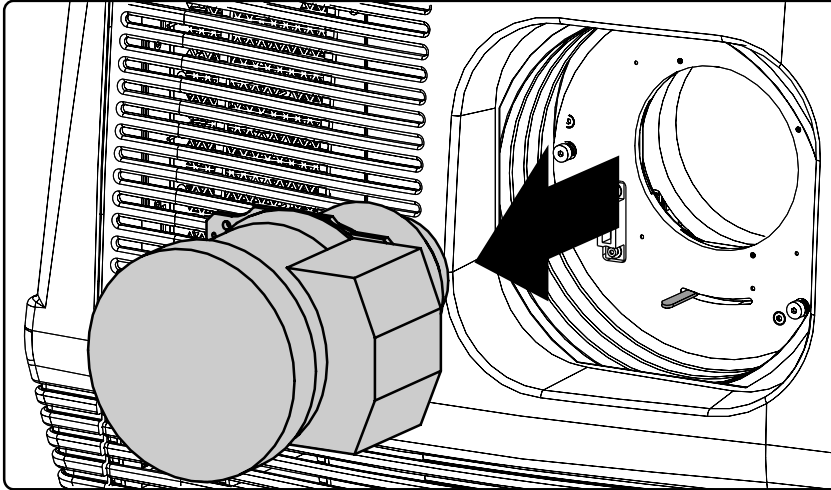

Image 3-21



It's recommended to place the Lens caps of the original Lens packaging, back on both sides of the removed Lens to protect the optics of the Lens.



It's recommended to place the foam rubber of the original projector packaging, back in the Lens opening to prevent intrusion of dust. Note that this foam rubber is packed in a plastic bag to prevent the dust, emitted by the foam, from entering the projector.

3.3 Alignment of a table mount FLM projector

How to align a table mount FLM projector ?

1. Place the projector in the desired location. Take into account the zoom range of the used lens and the size of the screen.
2. Project one of the internal hatch patterns on the screen.
3. Turn the adjustable feet in or out until the projected hatch pattern is perfectly rectangle shaped and leveled.

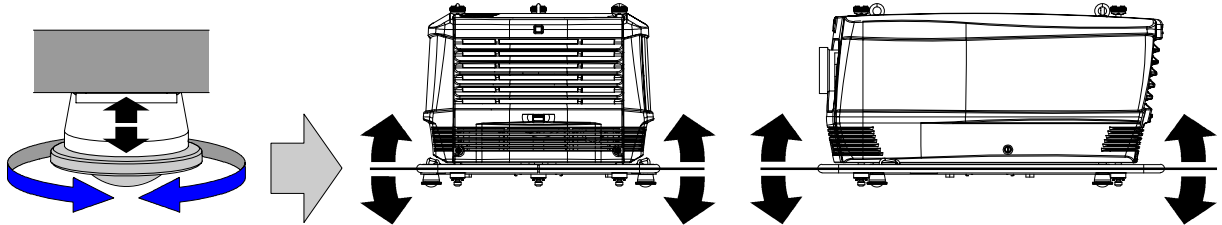

Image 3-22

When this is achieved, the projector is set horizontal and vertical at right angles to the screen.

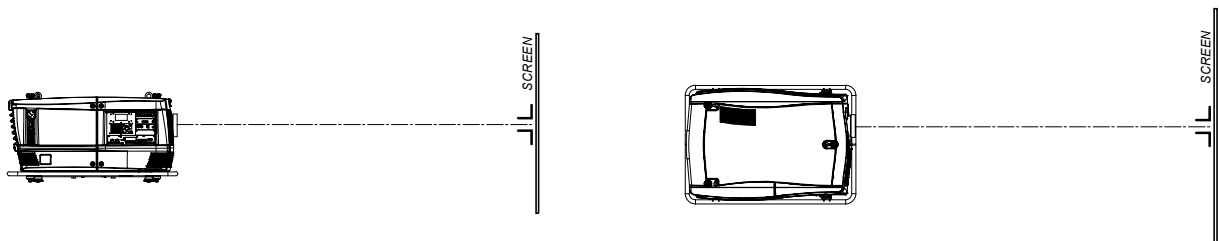

Image 3-23

3.4 Alignment of a ceiling mount FLM projector

Necessary tools

17 mm open ended spanner.

How to align a ceiling mount FLM projector ?

1. Install the projector in the desired location. See installation procedure "Suspension of the FLM projector with rigging clamps", page 28. Take into account the zoom range of the used lens and the size of the screen.
2. Project one of the internal hatch patterns on the screen.
3. Release the lock nut (ref B image 3-24) of the rigging clamps.
4. Adjust the height of the rigging clamps with respect to the projector, until the projected hatch pattern is perfectly rectangle shaped and leveled.

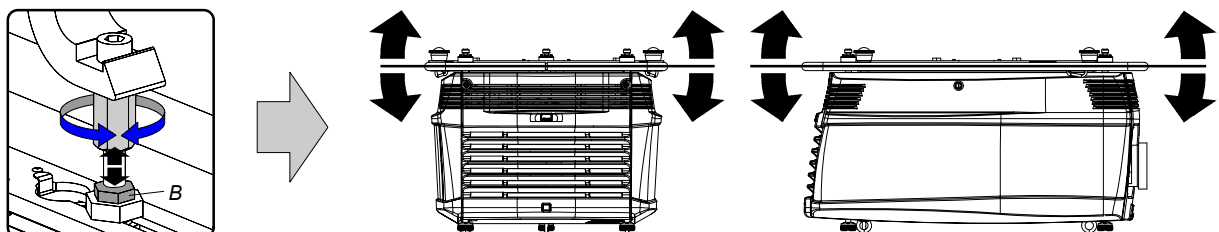

Image 3-24

3. Physical installation

When this is achieved, the projector is set horizontal and vertical at right angles to the screen.

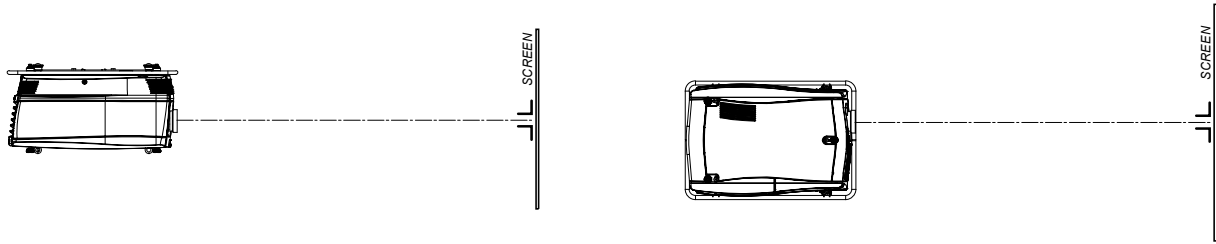

Image 3-25

5. Fasten the lock nut (B) of the rigging clamps.

3.5 Suspension of the FLM projector with rigging clamps

Rigging points and rigging clamps

The carrying handle, at the bottom side of the projector, is provided with eight slots. Four slots are longitudinally (A) oriented and four slots are transversely (B) oriented. Each slot contains a rigging point of which the position in the slot can be adjusted depending on the size of the truss installation. The rigging clamps (C) can be attached to those rigging points, which allows an easy and fast physical setup of the projector in a hanging configuration.

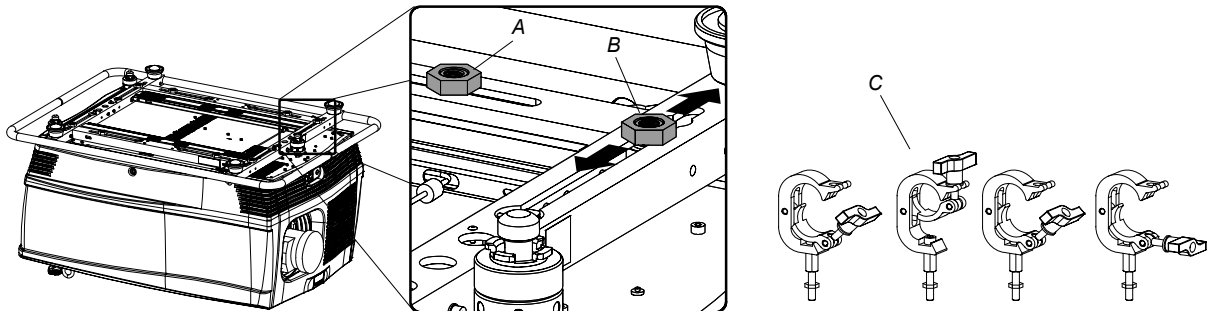

Image 3-26

Necessary tools

- 24 mm open ended spanner.
- 17 mm open ended spanner.

Necessary parts

- Four rigging clamps (R820411).
- Safety chains.

How to install and to use the rigging clamps ?

1. Measure the distance, center tube as reference, between the two used support bars of the truss.

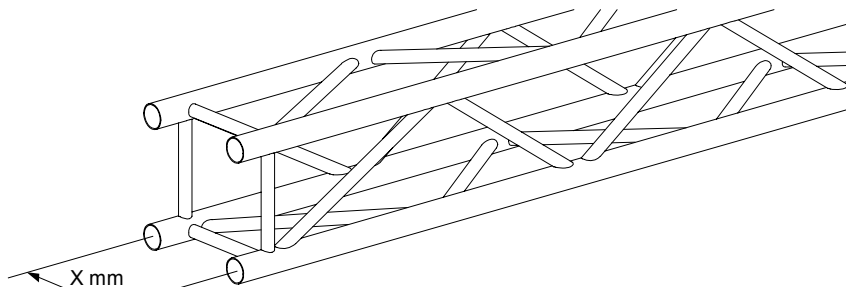

Image 3-27

2. Turn the projector upside down and slide the rigging points on there place in the slots, according the measured distance and secure this position. To release the nuts of the rigging points use a 24 mm open ended spanner. Ensure that the rigging points are symmetrically lined up, so that the projector will hang in balance.

Warning: Be careful while working with heavy loads.

Warning: Always secure the rigging points after adjustment.

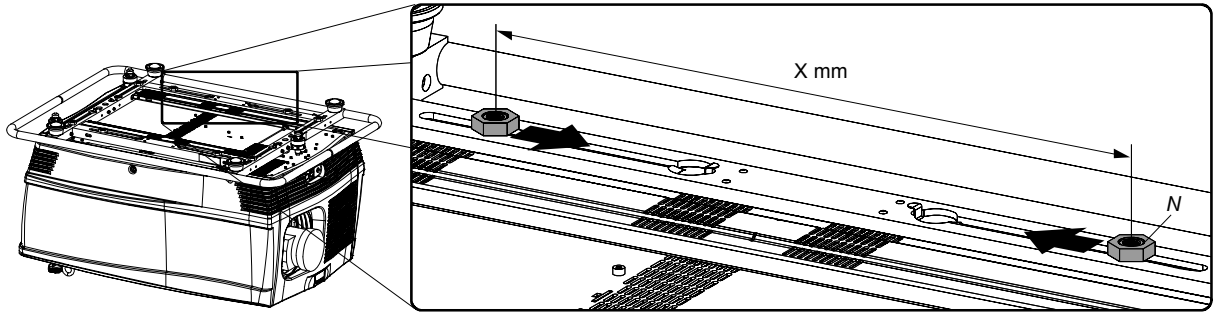

Image 3-28

- Turn in the rigging clamps (A) into the rigging points using a 17 mm open ended spanner and secure the rigging clamps by turning the safety nut (B) on the rigging clamp against the rigging point using a 17 mm open ended spanner.
- Warning:** Always use four (4) rigging points, equally spread, to suspend the projector.

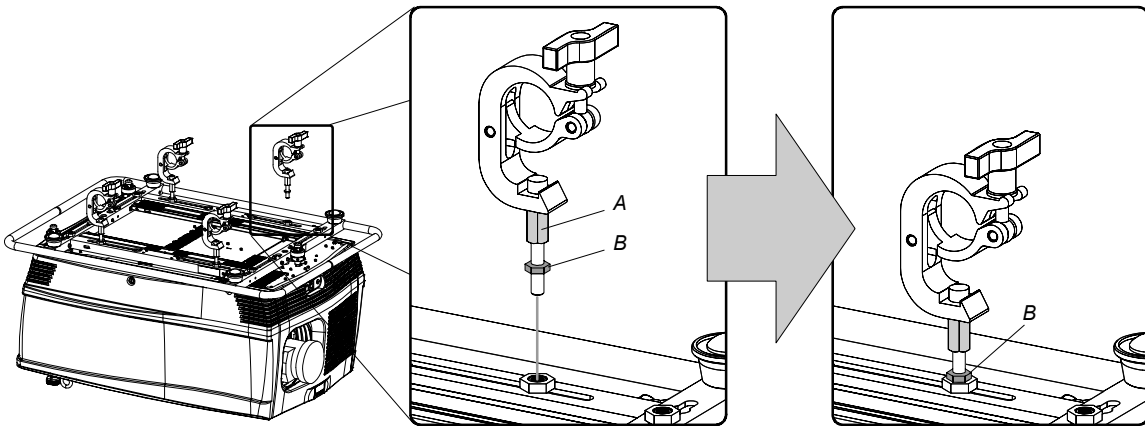

Image 3-29

- Place all four rigging clamps in open position as illustrated.

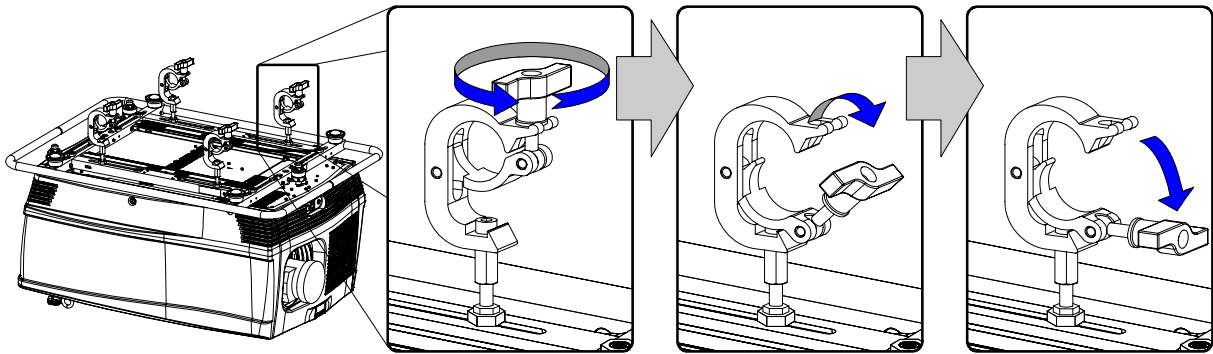

Image 3-30

- Place the projector (upside down) under the truss installation and lower the truss until the support bars of the truss are nearby the rigging clamps mounted on the projector.

3. Physical installation

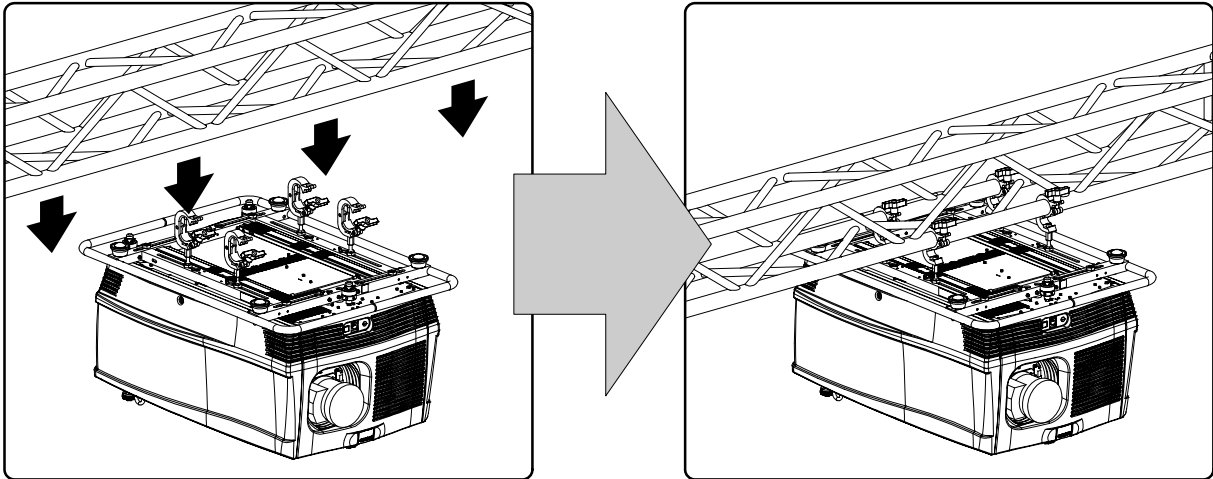

Image 3-31

6. Lift up the projector and hook the four rigging clamps over the support bars of the truss.
7. Lock all four rigging clamps.
8. Install a safety chain (S) around both sides of the carrying handle and around the truss.

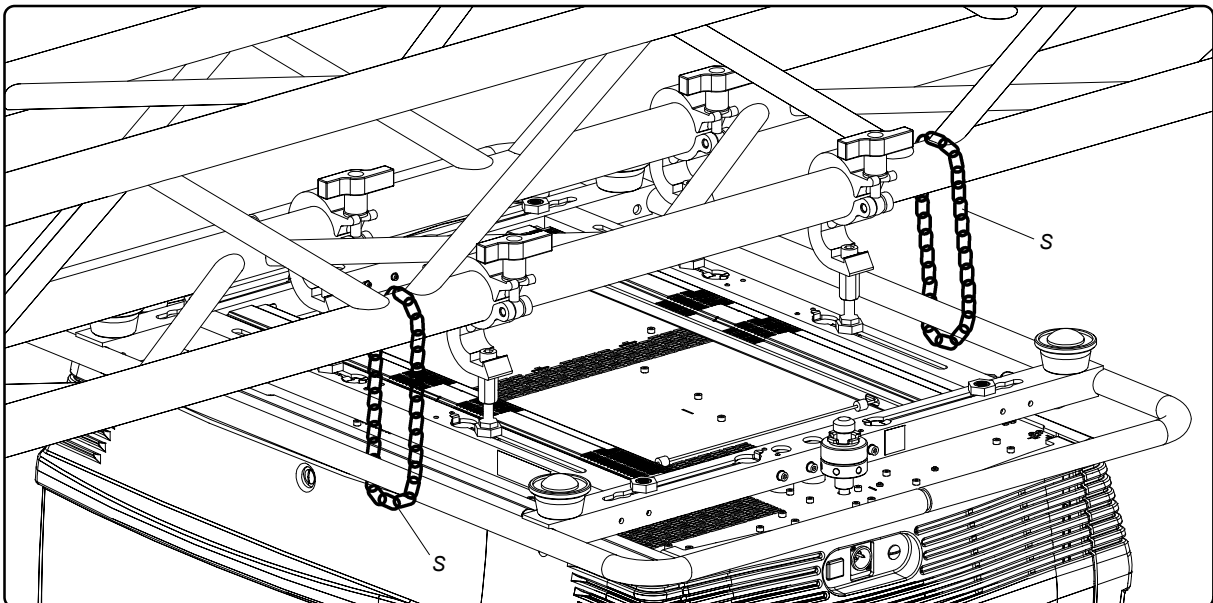

Image 3-32

9. Lift up the truss with attached projector to the desired height.



Proceed with the alignment procedure, see "Alignment of a ceiling mount FLM projector", page 27.

4. STACKING FLM PROJECTORS

General

Three interlocking adapters at the top and at the bottom of the FLM projector allows an easy and fast stacking without using extra tools or accessories.



WARNING: Maximum stack three (3) FLM projectors in a table mount configuration.

Maximum stack two (2) FLM projectors in a ceiling mount configuration.

Overview

- Stacking FLM projectors
- Aligning stacked FLM projectors

4.1 Stacking FLM projectors

How to stack FLM projectors ?

1. Turn in the four feet of the projector you want to stack.
2. Place the projectors on top of each other. Ensure that all three interlocking pins (A) match with their corresponding interlocking sockets (B).

Tip: In case of stacking projectors for a ceiling mount configuration, first turn the projectors upside down before placing the projectors on top of each other.

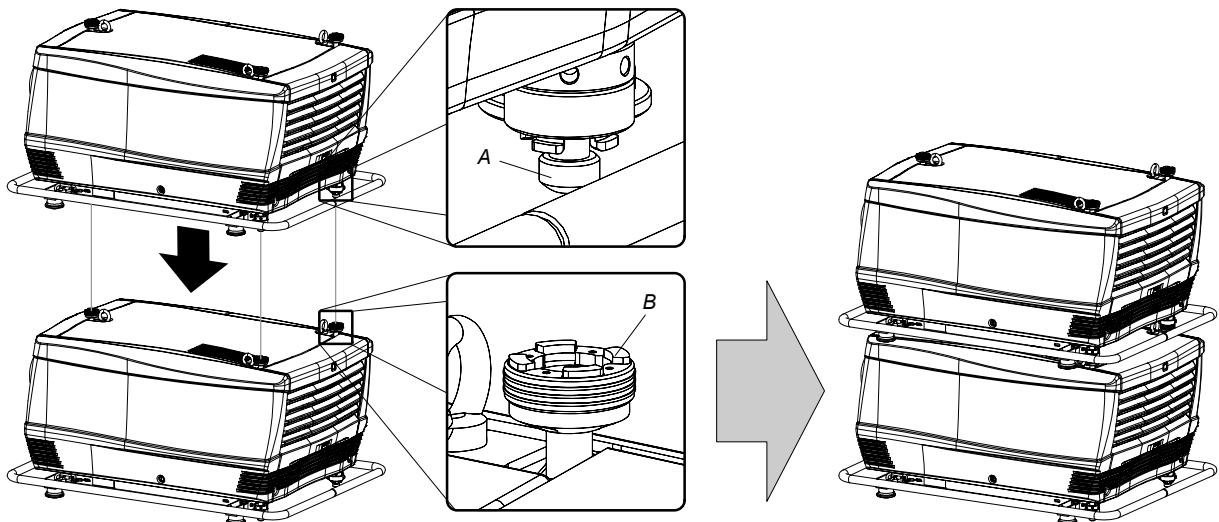

Image 4-1

3. Attach the two projectors together by closing all three interlocking adapters as illustrated.

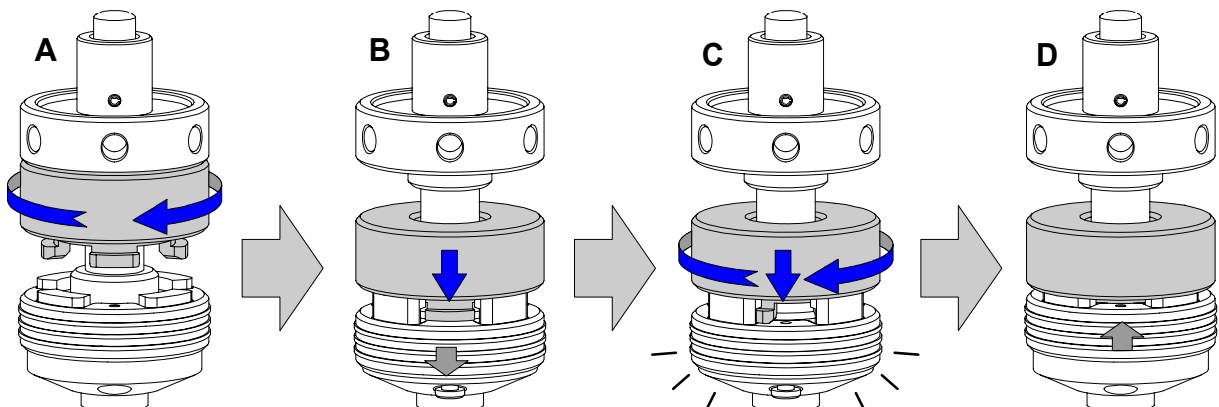

Image 4-2

4. Stacking FLM projectors

4. Are these projectors stacked for a ceiling mount configuration?

If yes, secure the projectors with safety chains as follows:

a) Release the safety hook (H) at both sides of the lowest projector and guide the safety cable around its carrying handle (C) as illustrated.

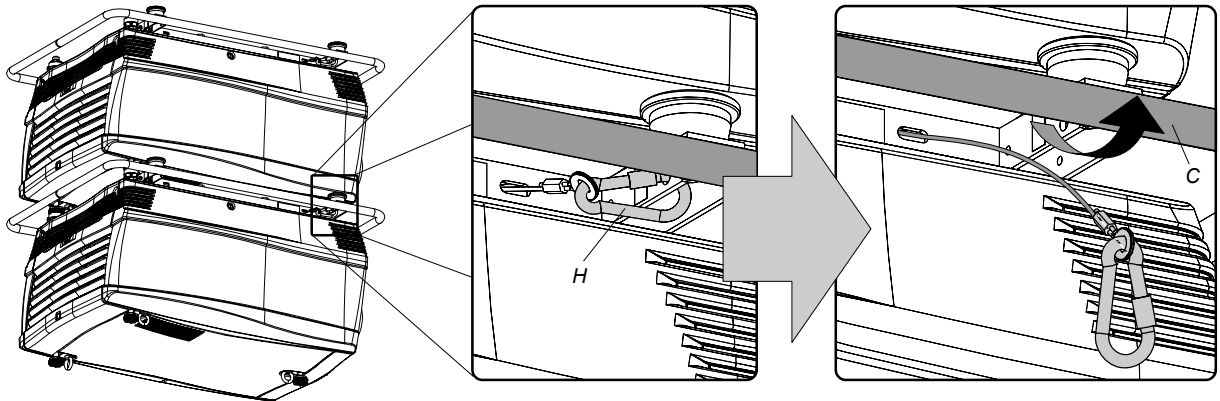

Image 4-3

b) Guide the safety cable around the carrying handle of the projector above and clasp the safety hook around the safety cable as illustrated.

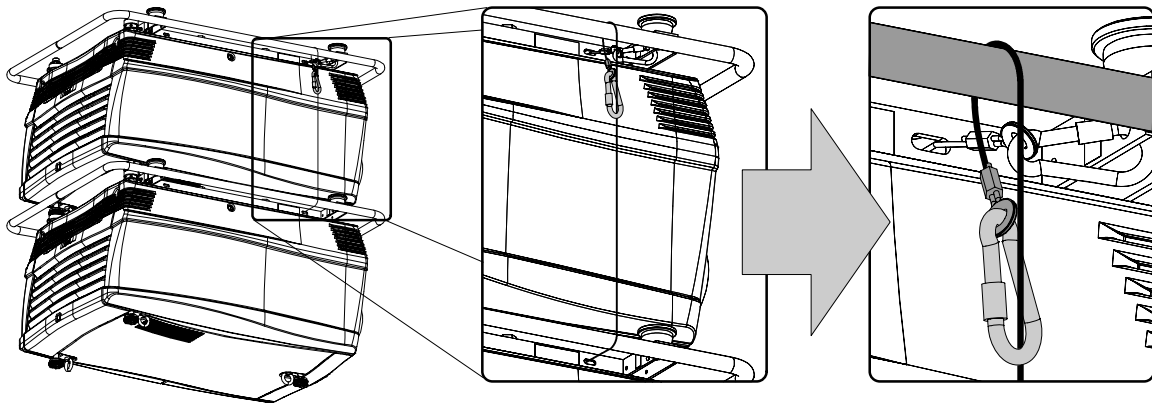

Image 4-4



WARNING: Always use both safety cables of the lowest projector to secure a stacked projector in a ceiling mount configuration.

How to open an interlocking adapter ?

1. Open an interlocking adaptor as illustrated.

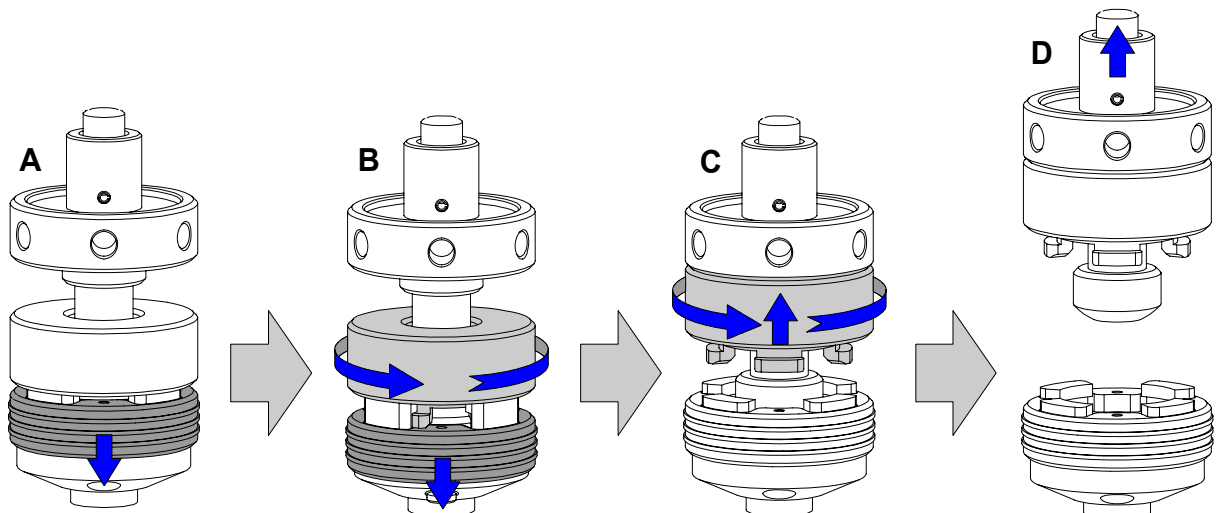

Image 4-5



WARNING: Never open an interlocking adapter of a stacked projector which is still suspended. First place the stacked projectors on the floor.

4.2 Aligning stacked FLM projectors

Necessary tools

8 mm Allen key.

How to align two stacked FLM projectors ?

1. Make sure that the internal hatch pattern projected by the reference projector is sharp and has a perfect rectangle outline. If this is not the case, readjust the reference projector before aligning the other stacked projector(s) with the reference hatch pattern.
Note: The reference projector in a stacked configuration is the lowest projector in case of table mount and the uppermost projector in case of ceiling mount.
2. Project with the stacked projector the same internal hatch pattern as the reference projector.
Tip: Use a white colored hatch pattern for the reference projector and e.g. green colored for the stacked projector. This makes it easier to see the difference between both hatch patterns projected.
3. If necessary, adjust the rotation of the stacked projector with respect to the reference projector by turning in or out the height adjustment ring of the interlocking adapters at the rear of the stacked projector. Adjust until the outline of the hatch pattern is most symmetric with the reference hatch pattern.
Tip: You can increase leverage by using a screw driver in the holes of the adjustment ring

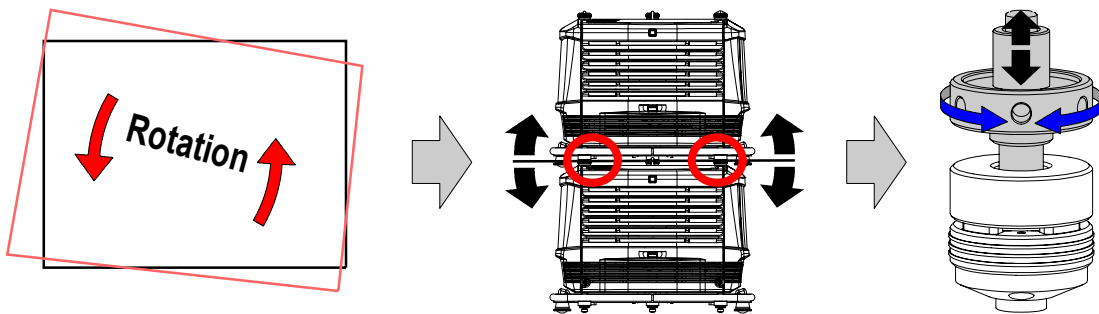

Image 4-6

4. If necessary, adjust the inclination of the stacked projector with respect to the reference projector by turning the height adjustment ring of the interlocking adapter at the front of the stacked projector in or out. Adjust until the outline of the hatch pattern is most symmetric with the reference hatch pattern.

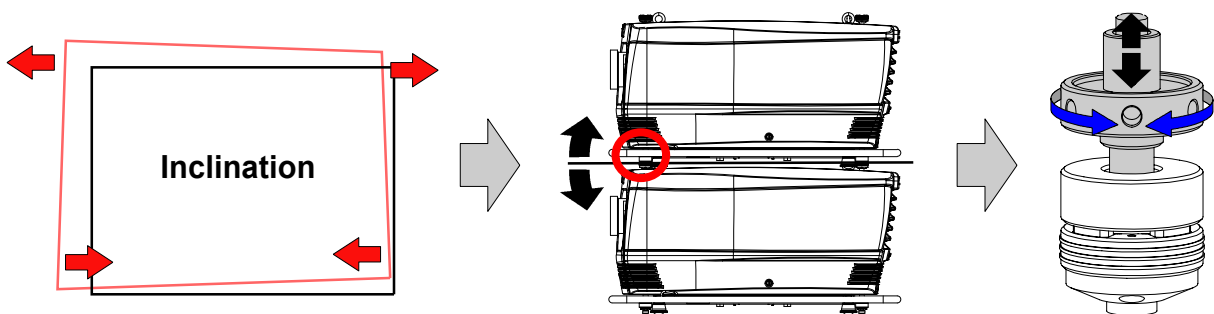

Image 4-7

5. If necessary, adjust the skew of the stacked projector with respect to the reference projector by turning the screw Q in or out using a 8 mm Allen key. The screw Q is located behind the cover of the lamp, just above the volt meter. Adjust until the outline of the hatch pattern is most symmetric with the reference hatch pattern.
Note: See procedure "Removal of the lamp cover", page 195, to access the skew adjustment screw Q.

4. Stacking FLM projectors

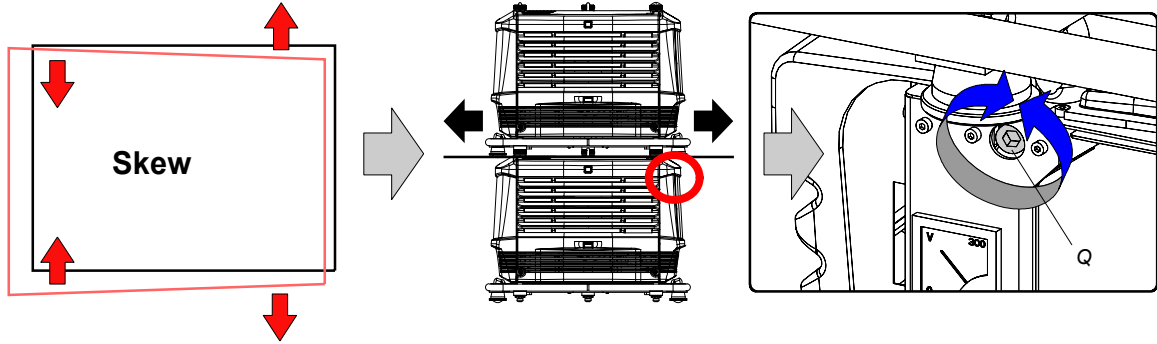

Image 4-8

6. Shift the hatch pattern horizontally and vertically until the outline of the hatch pattern is most symmetrically placed with respect to the reference hatch pattern.

Note: Note that the "Shift" function is motorized, which means that you have to access the projector software, via the local keypad or remote control unit, to operate the "Shift" function.

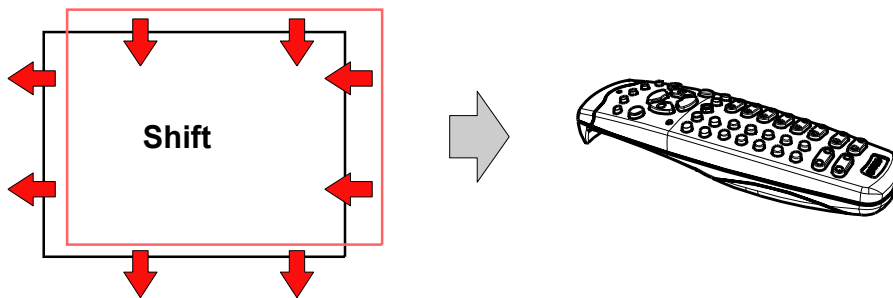

Image 4-9

7. Zoom the hatch pattern in or out until the outline of the hatch pattern matches exactly the outline of the reference hatch pattern.

Note: Note that the "Zoom" function is motorized, which means that you have to access the projector software, via the local keypad or remote control unit, to operate the "Zoom" function.

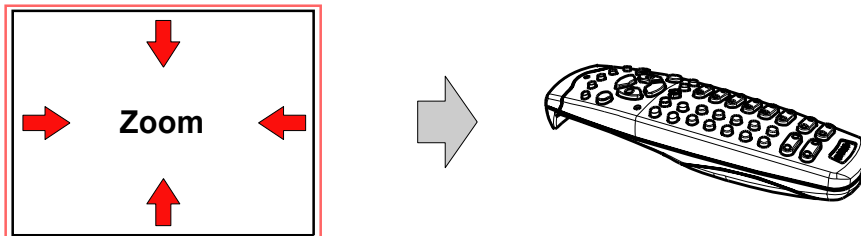

Image 4-10

8. If necessary, repeat from step 2 until the hatch pattern of the stacked projector is perfectly aligned with the hatch pattern of the reference projector.



In case of a triple stacked table mount projector configuration adjust and align first the bottommost projector (reference), then the projector in the middle and finally the uppermost projector.

5. CONNECTIONS

About this chapter

This chapter describes more in detail the power (P), the input source (S) and the communication (C) connections of the FLM R22+.

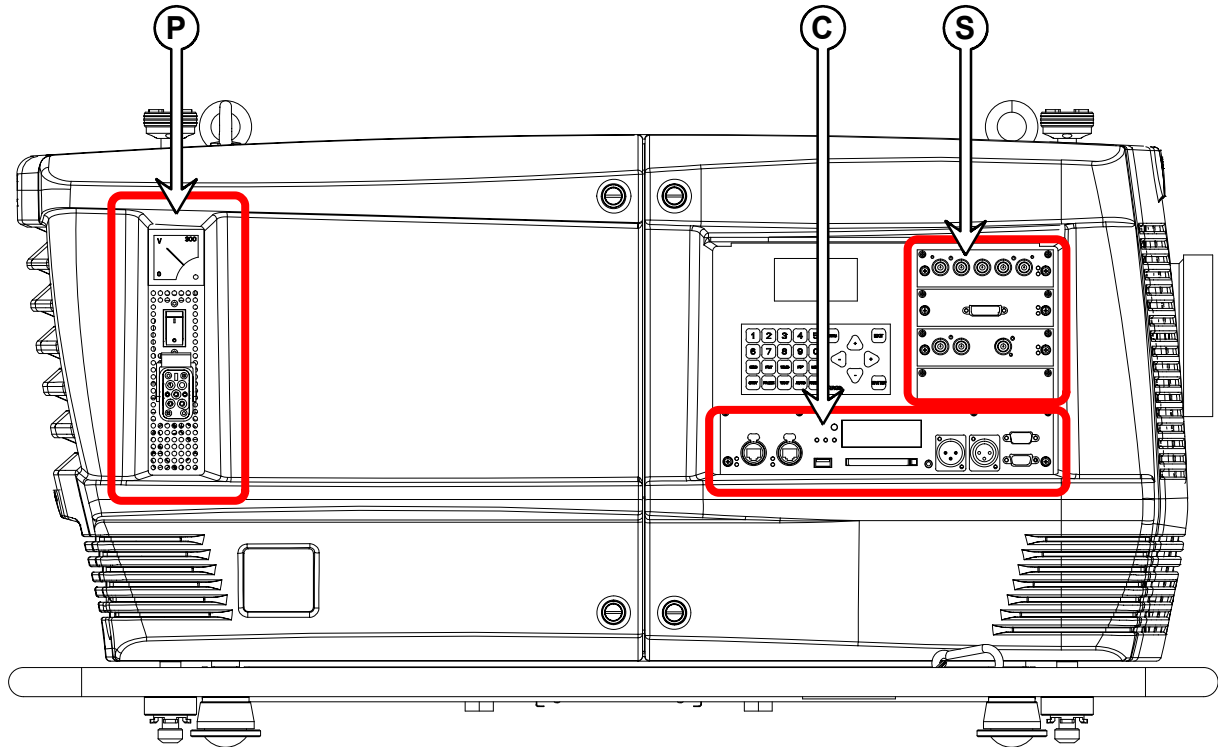

Image 5-1

Overview

- Power connection
- Input source connections
- Communication connections

5.1 Power connection



CAUTION: Use only the power cord provided with the projector.

How to connect your projector with the local power net ?

1. Ensure that the power switch (S) stands in the "0" (OFF) position.
2. Connect the power cord (P) with the power input socket of the projector as illustrated below.
3. Secure the power plug by locking the plug holder clamp (H).
4. Connect the other end of the power cord with the local power net.
Caution: Ensure that the power net meets the power requirements of the projector, which are: 200-240 VAC, 50-60 Hz, 18 amps at 230 VAC.

5. Connections

The voltmeter (M) will immediately indicate the value of the mains voltage as soon as the projector is connected with the power net.

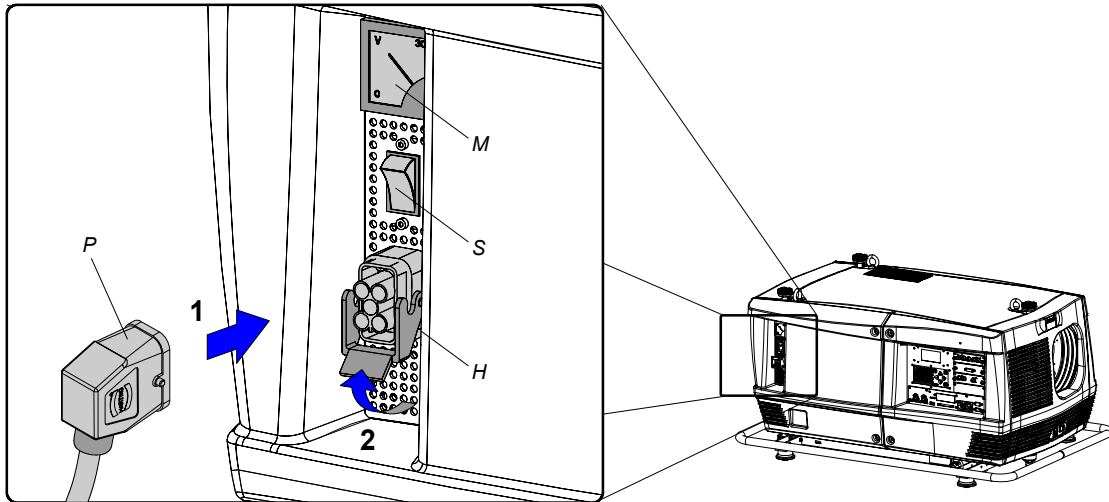

Image 5-2



WARNING: Do not attempt operation if the AC supply and cord are not within the specified voltage and power range.



CAUTION: Once the projector is switched to standby, the lamp cooling fans will continue to run for approximately five minutes to ensure that the projector and lamp have sufficiently cooled, at which point the fans will automatically decrease to standby. To avoid thermal stress that can lead to premature lamp failure, never unplug the power cord while the lamp cooling fans are running. Never unplug the power cord to power down the projector, first switch off the power switch and then unplug the power cord.

Fuses

The projector is protected with an automatic circuit breaker of 35 A which is built in into the power switch.

Volt meter

After starting up the projector (lamp ignition) check if the value indicated by the volt meter is still within the specified power range of the projector. Note that in case the power net drops significantly during start up, the lamp will fail the ignite. If this is the case, take the necessary measures to reinforce the power net to the projector before starting up the projector again.

Spare power plug

The projector is delivered with a spare power plug. This spare power plug is attached behind the nameplate of the projector. Remove the cover of the lamp first to access this spare power plug, see "Removal of the lamp cover", page 195. Note that only qualified technical personnel may install a new power plug.

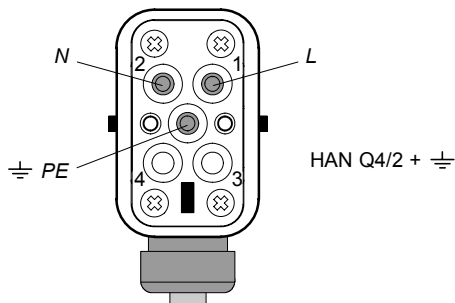

Image 5-3
Pin configuration power plug HAN Q4/2 + PE.

5.2 Input source connections

General

The input and communication unit is equipped with four input slots, which accept any type of input module designed for the FLM projector. The modularity of the input modules makes the FLM projector very flexible regarding input source connectivity. Note that the slot numbering is done from top to bottom. So, the uppermost slot is slot number "1", the second is slot number "2"... etc. All input modules have two status LED's. The green LED lights up if the input module is selected as the active input module. The yellow LED lights up if the input module has detected valid input syncs.

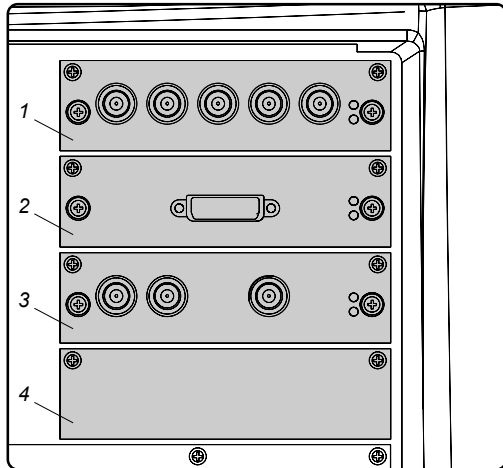
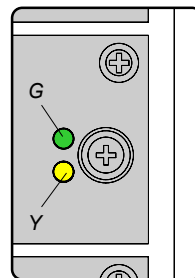

Image 5-4



CAUTION: Always install a cover plate on an unused input slot. This to prevent dust intrusion into the projector.

Available input modules



Image 5-5
5 Cable input (Multi purpose) (R9854430).



Image 5-6
5 Cable input (Multi purpose) (R9854435).



Image 5-7
HDSDI - SDI input (R9854450).



Image 5-8
DVI input (R9854460).



Image 5-9
HDCP DVI input (R9854465).



Image 5-10
Cover plate for unused input slot (R848607).



The FLM R22+ is standard equipped with one 5 cable input module, one HDSDI - SDI input module and one DVI input module. Input slot number 4 (lowermost) is covered with a input cover plate.



For more information about the FLM input modules see chapter "Specifications".

5.3 Communication connections

Communication interface

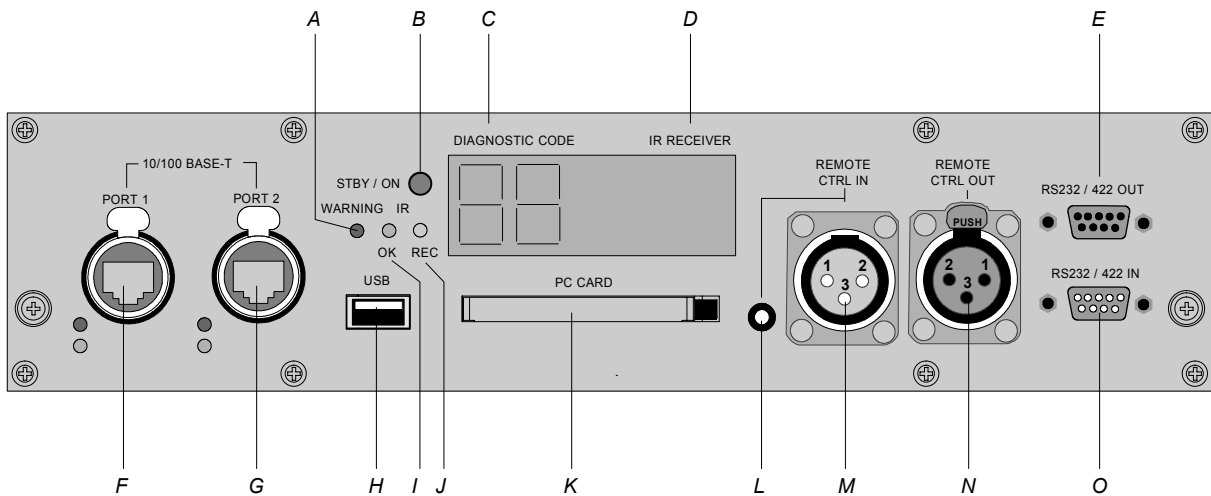

Image 5-11

- A Warning LED.
- B Projector status LED.
- C Two digit LED display for diagnostic code.
- D IR-receiver (side).
- E RS232/422 loop through output port.
- F Ethernet port 1.
- G Ethernet port 2.
- H USB port.
- I IR signal received LED.
- J IR signal acknowledged LED.
- K PCMCIA card-bus (slot).
- L Mini-jack input port for remote control.
- M XLR input port for remote control.
- N XLR output port for remote control.
- O RS232/422 input port.

Projector status

The projector "status" LED (B) lights up green while in operation. The same LED lights up red when the projector is switched to standby.

Besides the projector status LED (B) the communication interface has also a "warning" LED (A) which blinks in case the projector encounters an internal problem concerning fan speed, temperature, supply voltages, ... etc. These type of problems still allows the projector to operate (the show can go on) but an action will be required within a short time period. More information about the involved problem is given on the local LCD display of the projector.

A two character 7-segment display (C) shows, during normal operation, the selected input slot number. If an error has occurred then an error code appears on this two digit LED display.

IR communication (RC5)

An IR receiver (D) is mounted on the communication interface. Note that there is also an IR receiver mounted at the front and at the rear of the projector. When using the remote control unit (wired or wireless), the "IR REC" (I) and the "IR OK" (J) LED's will light up indicating an IR signal was received and recognized.

Wired remote control

If desired the remote control unit can be wired and plugged in into the 3,5 mm mini jack socket (L) or, when using a rugged wire with XLR plugs, plugged in into the male XLR port (M) on the communication interface. Besides the XLR input port a female XLR connector (N) for wired RC5 output is provided. This connector creates a buffered RC5 signal, available for the next projector in the daisy chain. Whenever the projector has no power, a passive loop through is created from the remote control input port to the

female XLR output port (N). So, the following projector in the daisy chain will still receive his RC5 code. Note that the RC5 in/out signals are without carrier.

Mini jack plug		XLR – Remote CTRL in		XLR – Remote CTRL out	
Pin	Description	Pin	Description	Pin	Description
S	GND	1	GND	1	GND
T	RC5 in	2	RC5 in	2	RC5 out
R	n.c. or GND	3	XLR present sense	3	XLR present sense

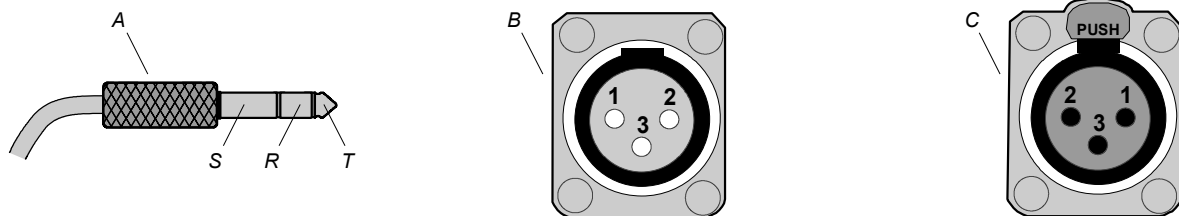

Image 5-12

A Mini stereo jack plug.

- S : Sleeve (shield)
- R : Ring
- T : Tip

B Male XLR socket.

C Female XLR socket.

RS232/422 serial communication

The communication interface of the FLM R22+ supports RS232 and RS422 serial communication. You can use the RS232/RS422 input port (O) to connect a local PC to your FLM projector. This way you can configure and control your FLM projector from your local PC.



Do not forget to set the projector's baud rate (default = 115200) to match that of the computer.

The communication interface has also an active RS232/RS422 loop through output port (E). Whenever the projector has no power, a passive loop through is created from the RS232/RS422 input port (O) to the RS232/RS422 output port (E). So, the following projector in the daisy chain will still receive his RS232/RS422 commands.

Advantages of using RS232/RS422 serial communication:

- easy adjustment of the projector via PC (or MAC).
- allow storage of multiple projector configurations and set ups.
- wide range of control possibilities.
- address range from 0 to 255.
- sending data to the projector (update).
- copying data from the projector (backup).

RS232/422 input port	
Pin	Description
1	DCD : Data Carrier Detect
2	RXD- : Receive Data
3	TXD- : Transmitted Data
4	DTR : Data Terminal Ready [RS232] TXD+ : Transmitted Data [RS422]
5	GND : Ground
6	DSR : Data Set Ready [RS232] RXD+ : Received Data [RS422]
7	— (not connected) —

RS232/422 output port	
Pin	Description
1	— (not connected) —
2	RXD- : Receive Data
3	TXD- : Transmitted Data
4	DTR : Data Terminal Ready [RS232] TXD+ : Transmitted Data [RS422]
5	GND : Ground
6	DSR : Data Set Ready [RS232] RXD+ : Received Data [RS422]
7	— (not connected) —

RS232/422 input port	
Pin	Description
8	CTS : Clear To Send
9	RI : Ring Indicator

RS232/422 output port	
Pin	Description
8	— (not connected) —
9	— (not connected) —

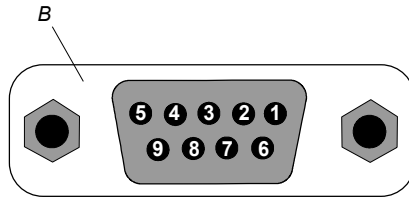
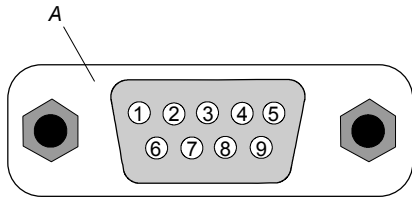

Image 5-13
 A Pin numbering male DB-9 connector.
 B Pin numbering female DB-9 connector.



RS232

An Electronic Industries Association (EIA) serial digital interface standard specifying the characteristics of the communication path between two devices using either D-SUB 9 pins or D-SUB 25 pins connectors. This standard is used for relatively short-range communications and does not specify balanced control lines. RS-232 is a serial control standard with a set number of conductors, data rate, word length and type of connector to be used. The standard specifies component connection standards with regard to computer interface. It is also called RS-232-C, which is the third version of the RS-232 standard, and is functionally identical to the CCITT V.24 standard. Logical '0' is > + 3V, Logical '1' is < - 3V. The range between -3V and +3V is the transition zone.



RS422

An EIA serial digital interface standard that specifies the electrical characteristics of balanced (differential) voltage, digital interface circuits. This standard is usable over longer distances than RS-232. This signal governs the asynchronous transmission of computer data at speeds of up to 920,000 bits per second. It is also used as the serial port standard for Macintosh computers. When the difference between the 2 lines is < - 0.2V that equals with a logical '0'. When the difference is > +0.2V that equals to a logical '1'.

Ethernet network communication

The FLM projector can be connected to a LAN (local area network) using port 1 (F) or port 2 (G) on the communication interface. Once connected to the LAN, users are capable of accessing the projector from any location, inside or outside (if allowed) their company network using the FLM control software: Projector Toolset. This toolset locates the projector on the network in case there is a DHCP server or the user can insert the correct IP-address of the projector to access the projector. Once accessed, it is possible to check and manipulate all the projector settings. Remote diagnostics, control and monitoring of the projector can then become a daily and very simple operation. The network connectivity permits to detect potential errors and consequently improve the time to servicing.

As there is a need to daisy chain projectors when they are in Ethernet network, an Ethernet switch is build in. the incoming network is hereby available for the internal PC and for the next device in the chain. In this way a 'star' network interconnection can be avoid. The switch used is a stand alone 10/100Mbit Ethernet switch. This assures no influence on the network speed. Whenever a slow (10Mbit) device is connected the speed between the 100Mbit devices remains 100Mbit.

Both Ethernet ports (F & G) are equipped with a yellow and green a LED. The yellow LED lights up in case the port is connected with a 100Mbit network. The green LED blinks in case there is network activity.



The connectors used for both Ethernet ports (F & G) are of rugged Neutrik EtherCon RJ45 type, which is compatible with standard RJ45 cable connector. Straight (most common) as well as cross linked network cables can be used. The 2 ports are functionally identical. Both ports are connected via the projector hub (Auto sensing enabled).

10/100 Base-T — RJ45 port	
Pin	Description
1	TXD+
2	TXD-
3	RXD+
4	—
5	—
6	RXD-

10/100 Base-T — RJ45 port**Pin Description**

7 —

8 —

USB port

The communication interface is equipped with a master USB port, type “A” connector (H). This USB port will simplify the service procedures for taking backup files from the projector without network connection. An USB-stick is plugged into the USB port and files can be transferred from or to the projector using the local or remote control unit. Note that the USB-stick has to be FAT16 compatible.

Card bus connector (PCMCIA)

No cards supported yet.

6. GETTING STARTED

About this chapter

This chapter describes the functions on the remote control and local keypad and gives an overview how to start up the projector. It gives also a brief overview of the direct adjustment possible with these controls.

Overview

- RCU & Local keypad
- Terminology overview
- Operating the projector
- Using the RCU
- Quick setup adjustments
- Projector Address
- Source selection
- Controlling the Projector

6.1 RCU & Local keypad

How controlling the projector ?

The projector can be controlled by the local keypad or by the remote control unit.

Location of the local keypad ?

The local keypad is located on the input side of the projector.

Remote control functions.

This remote control includes a battery powered infrared (IR) transmitter that allows the user to control the projector remotely. This remote control is used for source selection, control, adaptation and set up.

Other functions of the remote control are :

- switching between stand by and operational mode.
- switching to "pause" (blanked picture, full power for immediate restarting)
- direct access to all connected sources.

6.2 Terminology overview

Overview

The following table gives an overview of the different functionality of the keys.

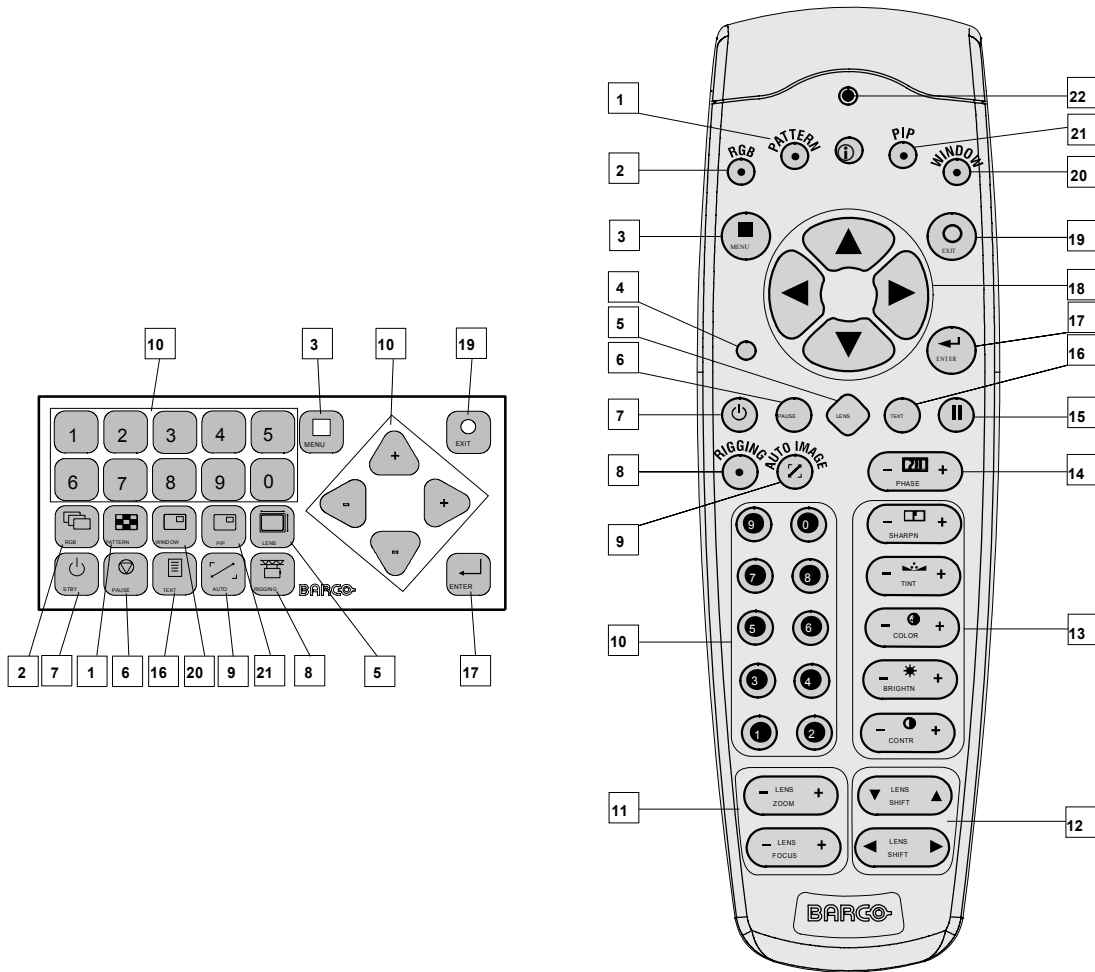

Image 6-1
Local keypad & remote control

Ind.	Key name	Description
1	Pattern key	Direct access key to the internal pattern selection menu. or when an on-screen menu was displayed, the pattern is displayed immediately.
2	RGB	Toggle key to enable and disable colors in the adjustment mode. Toggle between red, green, blue and full RGB.
3	MENU	Access key to the menu structure and key to quickly quit the adjustment menus.
4	Address key	(recessed key), to enter the address of the projector (between 0 and 9) in the remote control. Press the recessed address key with a pencil, followed by pressing one digit button between 0 and 9.
5	LENS	Direct access key to the lens adjustment menus. Toggling this key will change the projected pattern.
6	PAUSE	To stop projection for a short time, press 'PAUSE'. The image disappears but full power is retained for immediate restarting. Shutter is closed.
7	STBY	Standby function switch off the lamp and lamp electronics. The lamp cooling fans remain active for about 5 minutes. The speed of the other fans is reduced.
8	Rigging	Direct access key to layout selection. Rigging key + sequence number opens directly the desired layout.
9	Auto image	Direct access key to automatically project the correct image.
10	Digit buttons	Direct input selection or menu short cuts or numeric entries
11	Lens zoom/focus	Zoom and focus controls of the lens
12	Lens shift	Shift control of the lens, to shift the lens up/down or left/right
13	Picture controls	Use these buttons to obtain the desired picture level.

Ind.	Key name	Description
14	PHASE	Used to remove the horizontal instability of the image (usually for RGB source). It adjusts the phase of the pixel sampling clock relative to the incoming signal.
15	FREEZE	To freeze the actual projected image. Freeze sign is displayed in the upper left corner (a short press on the key). When pressing for 5 sec, the projector goes into stand-by. The lamp cooling fans remain active for about 5 minutes. The speed of the other fans is reduced.
16	TEXT	Toggle key to activate or deactivate on screen text boxes while adjusting a setting. When adjusting one of the image controls, e.g.during a meeting, the normally displayed bar scale can be deactivated by pressing 'TEXT' key first. To re-display the bar scale on the screen, press 'TEXT' key again. When TEXT is 'off', no adjustment menu's will be displayed on the screen when entering the adjustment mode. All menus and adjustments remain active on the local LCD panel.
17	ENTER	Key to confirm an adjustment or selection in the adjustment mode.
18	Cursor keys	To make menu selections when in the adjustment mode
19	EXIT	Key to go one menu stage higher than the actual position when in the adjustment mode.
20	WINDOW	Selection of the active window, also in PIP mode.
21	PIP	Direct access key for picture in picture selection.
22	RC Operating indication	Lights up when a button on the remote control is pressed. (This is a visual indicator to check the operation of the remote control)

Table 6-1

6.3 Operating the projector

Overview

- Switching on
- Errors, warnings and messages during start up
- Switching to standby
- Switching off

6.3.1 Switching on

How to switch on.

1. Press the power switch to switch on the projector.

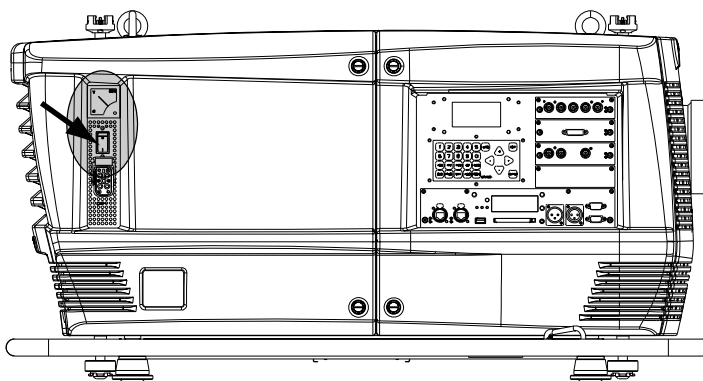
Image 6-2
Switching on

- When '0' is visible, the projector is switched off.
- When '1' is visible, the projector is switched on.

The projector starts up in standby. The menus are accessible via the local LCD panel.

To display an image, the standby key must be pressed once.



The actual input voltage is indicated on the voltmeter just above the power switch.

Starting image projection via the standby key.

1. Press **Stand by** key once on the local keypad or on the remote control.

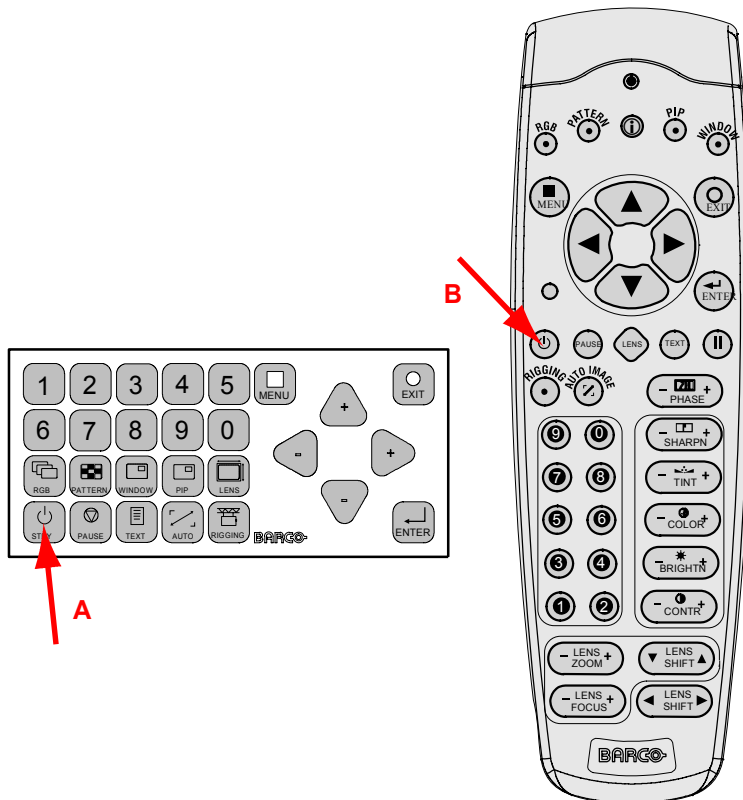

Image 6-3
Stand by indication

- A Stand by indication on local keypad
- B Stand by indication on remote control

The projector status LED lights up.

The projector starts up on the last saved source.

Some lamp and runtime warnings can be displayed when an image is displayed after a start up.

6.3.2 Errors, warnings and messages during start up

Temperature error DMD

When the temperature of one of the DMD's is too low or too high the projector is switched automatically to standby. An error code will be displayed on the local LCD panel. For a list of possible error codes, see "Error codes", page 213.

6.3.3 Switching to standby

How to switch to standby?

1. Press **Standby** to switch the projector to standby.

A cool-down counter (after cooling) starts counting down for 5 minutes (only visible on the local LCD panel). During this period the fans are still running.

A restart is possible during this period.



Switching to Standby. When the projector is running and you want to go to standby, press the standby key for 2 seconds. Do not press any longer on the standby key otherwise the projector will restart.



All custom settings are written to the internal backup device. A message 'Save data ...' indicates this process. Never switch off the projector while this message is displayed.



When pressing for at least 5 seconds on the Freeze button, the projector goes to standby without the risk of restart..

6.3.4 Switching off

How to switch off the projector?

1. Press first **Standby**.
2. Let cool down the projector until the fans decrease, at least 5 min.
3. Switch off the projector with the power switch.



CAUTION: Never switch off the projector while the message 'Save data ...' is displayed !

6.4 Using the RCU

Pointing to the reflective screen

1. Point the front of the RCU to the reflective screen surface.

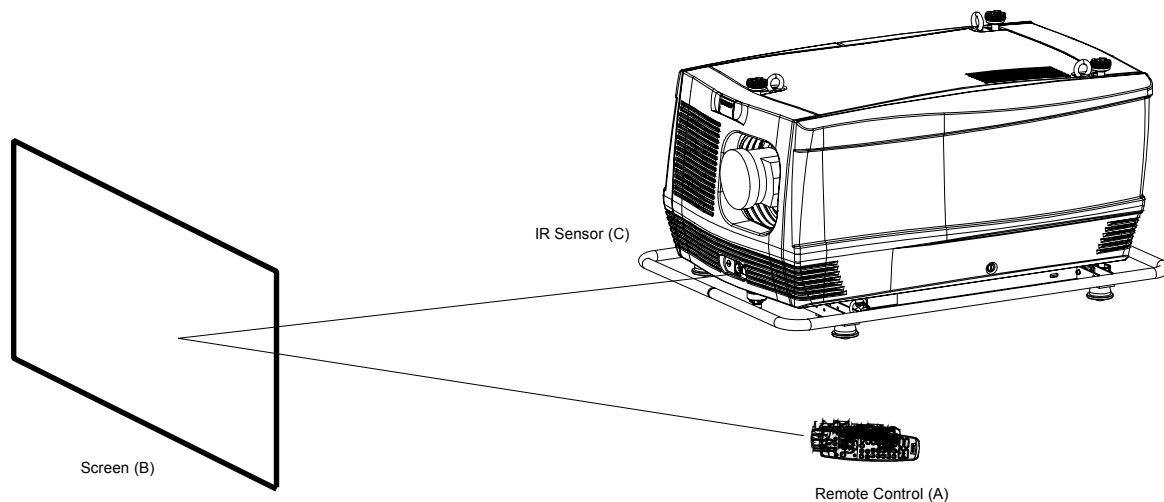

Image 6-4
IR control via the reflective screen

- A Remote control
- B Screen
- C Front IR-sensor

Hardwired Remote Input

1. Plug one end of the remote cable in the connector on the bottom of the RCU.

6. Getting started

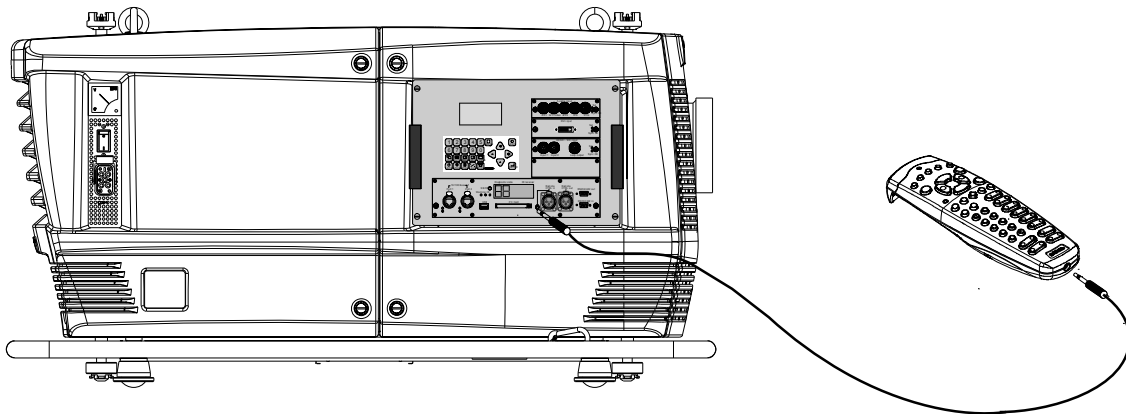

Image 6-5

2. Plug the other end in the small connector in the input panel of the projector labeled **Remote CTRL in**.



The Remote connection uses a standard two wire cable terminated on each end with a 3.5 mm male (mono/stereo) phone jack.

This cable is not delivered but is available in most electronic or audio shops.

Hardwired to the XLR input

1. Plug one end of the remote cable in the connector on the bottom of the RCU
2. Plug the other end in the big connector in the input panel of the projector labelled **Remote CTRL in**.

Directly to one of the IR sensors

When using the wireless remote control, make sure you are within the effective operating distance (30m, 100ft in a straight line). The remote control unit will not function properly if strong light strikes the sensor window or if there are obstacles between the remote control unit and the projector IR sensor.

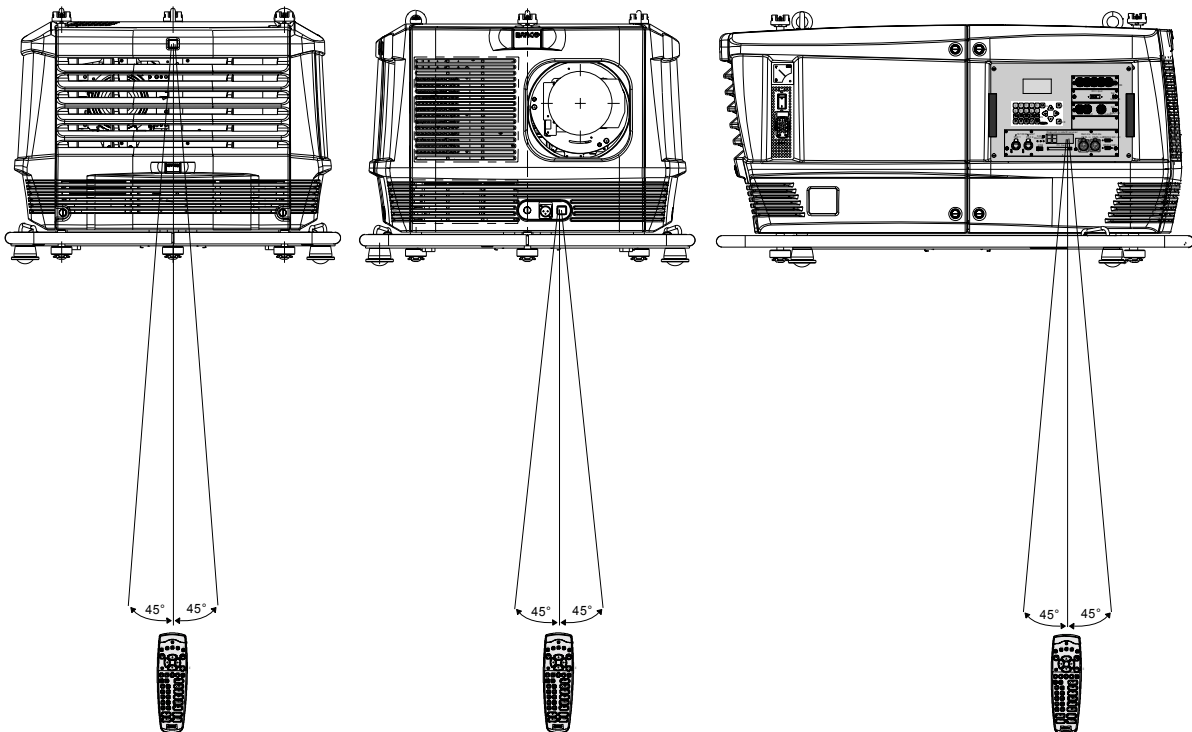

Image 6-6
RCU to one of the IR sensors

6.5 Quick setup adjustments

Overview

- Text boxes ON or OFF
- Quick Lens Adjustment
- Quick picture in picture
- Quick layout selection with Rigging key
- Quick language selection

6.5.1 Text boxes ON or OFF

Text toggle function

The on-screen text boxes can be switched OFF so that an adjustment during the operation of the projector are not visible on the screen. The adjustment indication remains visible on the local LCD screen.

To toggle Text ON or OFF, press the **TEXT** key on the remote control or local keypad.

6.5.2 Quick Lens Adjustment

6.5.2.1 Quick Lens Adjustment via LENS key

Quick zoom/focus adjustment

1. Press the **LENS** key on the remote control or local keypad.

The zoom/focus menu will be displayed.

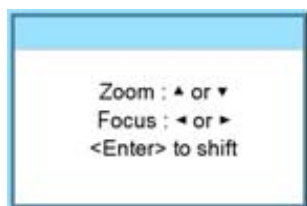

Image 6-7

2. Push the cursor key **▲** or **▼** to zoom and **◀** or **▶** to focus the image.
3. When finished, press **EXIT** key to return or **ENTER** to continue to the shift adjustment.



Press the **LENS** key to switch to another pattern. Different patterns are available.

Quick shift adjustment

1. Press the **LENS** key on the remote control or local keypad.

The zoom/focus menu will be displayed.

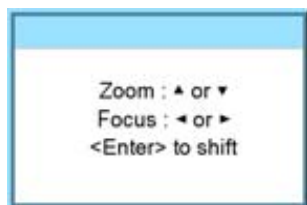

Image 6-8

2. Press **ENTER**.

6. Getting started

The shift menu will be displayed.



Image 6-9

3. Push the cursor key ▲ or ▼ to shift the image up or down and ◀ or ▶ to shift the image left or right.
4. When finished, press **EXIT** key to return or **ENTER** to continue to zoom/focus.



Press the **LENS** key to switch to another pattern. Different patterns are available.

6.5.2.2 Direct Lens Adjustment (RCU)

Lens adjustment buttons on the Remote Control

On the Remote Control four buttons with double action are provided, allowing direct alignment for lens ZOOM, FOCUS, HORIZONTAL SHIFT and VERTICAL SHIFT.

1. Press **LENS ZOOM** button [-] or [+] (A) for correct image size on the screen.

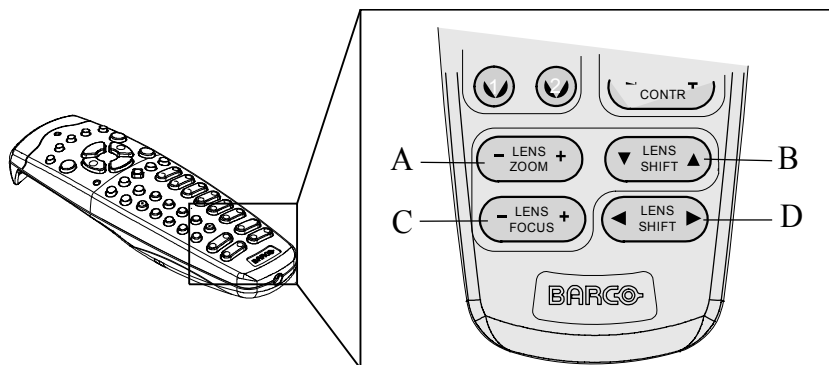

Image 6-10
Direct lens adjustment keys

- A Zoom
- B Vertical shift
- C Focus
- D Horizontal shift

2. Press **LENS FOCUS** button [-] or [+] (C) for an overall focus of the image.
3. Press ▲ **LENS SHIFT** ▼ button for correct vertical position of the image on the screen.
4. Press ◀ **LENS SHIFT** ▶ button for correct horizontal position of the image on the screen.

6.5.3 Quick picture in picture

Quick On - Off

Press on the **PIP** key on the remote control or the local keypad to activate the Load layout window.

Use the ▲ ▼ key to scroll to the desired layout and press **ENTER** to activate.



Select **Main full screen** to switch off PIP.

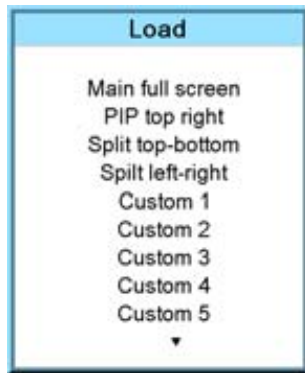

Image 6-11

6.5.4 Quick layout selection with Rigging key

What can be done ?

When the projector is playing, changing from one layout to another is possible without displaying any on screen selection menu. The current image is not disturbed as long no selection is made. Press the **Rigging** key followed by one or two digits to jump to a new layout.

When **Rigging** is pressed, an overview of the possible layouts with a sequence number is given on the local LCD panel. That sequence number is the number that should be pressed after Rigging is pressed to change the layout to the new selection.

How to make a selection

1. Press **Rigging** followed by one or two digits and wait.

Note: *If you press only one digit, the projector wait a few time to check if a second digit will follow. If not, it switches to the selected layout.*

The selected layout is loaded.

Or,

press **Rigging**.

The layout selection menu is displayed on the local LCD panel.

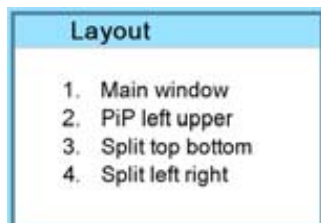

Image 6-12

2. Enter the digit or the two digits of your choice.

The selected layout is loaded.

Or,

scroll with the arrow keys to the desired layout and press **ENTER**.

The selected layout is loaded.



When no digit is pressed after Rigging is pressed, the layout selection menu disappears after a few seconds without a layout change.

6.5.5 Quick language selection

Language selection

1. Press **Menu** to activate the menus and select with the ▲ or ▼ key Projector Control and press **ENTER**.
2. Select with the ▲ or ▼ key Language and press **ENTER**.

The language menu opens.

3. Select with the ▲ or ▼ key the desired language and press **ENTER** to activate.

6. Getting started

The current active language is indicated with an asterisk (*).

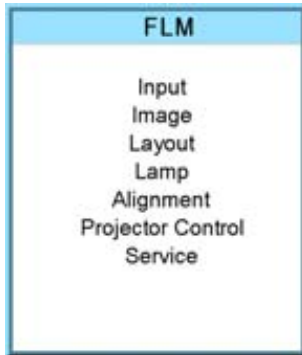

Image 6-13

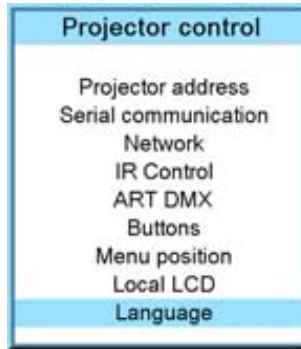

Image 6-14



Image 6-15

6.6 Projector Address

6.6.1 Displaying and Programming addresses

Displaying the Projector Address on the Screen.

1. Press **Address** key (recessed key on the RCU) with a pencil.

The projector's address is displayed as first item in the Identification screen.

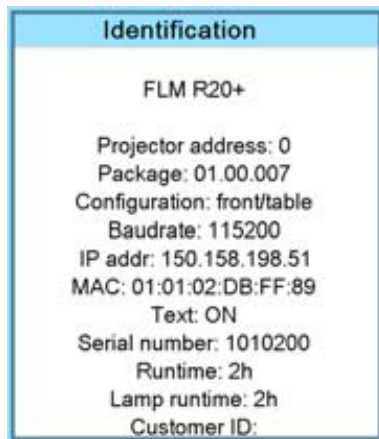

Image 6-16



To continue using the RCU with that specific address, it is necessary to enter the same address with the digit buttons (address between 0 and 9) within 5 seconds after pushing the address key. For example : if the Address key displays projector address 003, then press "3" digit button on the RCU to set the RCU's address to match the projector's address. Do not press 003 digits. This will address the remote control to '0' and control all projectors in the room. If the address is not entered within 5 seconds, the RCU returns to its default address (zero address) and control all projectors in the room.

How to Program an Address into the RCU?

1. Press the **Address** key (recessed key on the RCU) with a pencil.
2. Enter the address with the digit buttons within 5 seconds after pushing the address key.
Note: That address can be any digit between 0 and 9.



The LED on the remote control must lit up while pressing a digit key. Otherwise the address is not entered in the remote control.

6.6.2 Controlling the projector



Projector address

Address installed in the projector to be individually controlled.



Common address

Projector will always execute the command coming from a RCU programmed with that common address.

Why a projector address ?

As more than one projector can be installed in a room, each projector should be separately addressable with an RCU or computer. Therefore each projector has its own address.

Set up an individual Projector Address.

The set up of a projector address can be done via the software. See chapter 'Projector Control', 'Projector address'.

Projector controlling.

Every projector requires an individual address between 0 and 255 which can be set in the Service mode.

When the address is set, the projector can be controlled now:

- RCU for addresses between 0 and 9.
- computer, e.g. IBM PC (or compatible), Apple MAC, etc. for addresses between 0 and 255.

Common Address

Every projector has a common address '0' or '1'. The choice between '0' and '1' can be selected in *Projector Control* → *Projector address* → *Common address*.

6.7 Source selection

Source selection when no picture in picture is active

Use the digit keys on the remote control or local keypad to activate the desired source.

Source selection when picture in picture is active

Use the **Window** button on the remote control or the local keypad to select the main window or the picture in picture (PiP) window.

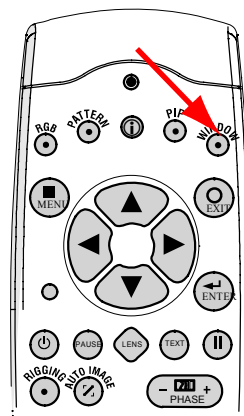
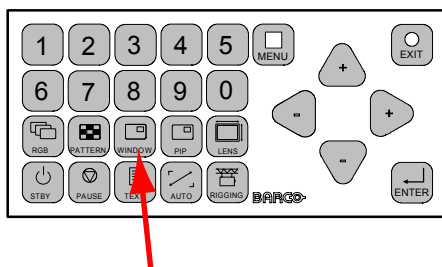

Image 6-17
Window selection button

The outline of the selected window gets a colored rectangle to indicate the selection. For the main window, the color is blue. For the picture in picture window, the color is orange.

Once the desired window is activated (main window or picture in picture window) all keys on the remote control or local keypad can now control that selected window.

To select the source for the picture in picture window, press Window button until PiP window is activated and then select the desired source with the digit keys.

To select the source for the main window, press Window button until the main window is activated and then select the desired source with the digit keys.

6.8 Controlling the Projector

Picture Controls

When an image control is pressed, a text box with a bar scale, icon and function name of the control, e.g. 'brightness...' appears on the screen (only if text is ON). See example screen. The length of the bar scale and the value of the numeric indication indicate the current memorized setting for this source. The bar scale changes as the control buttons on the RCU are pressed.

Brightness	A correct 'brightness' setting is important for good image reproduction. Use the + button for a higher brightness. Use the - button for a lower brightness.
Contrast	A correct 'contrast' setting is important for good image reproduction. Adjust the contrast to the level you prefer, according to room lighting conditions. Use the + button for a higher contrast. Use the - button for lower contrast.
Color	Color saturation is only active for all type of video sources, such as Video, S-Video, SDI, HDSDI. Adjust the color intensity of the picture. Use the + button for richer colors. Use the - button for lighter colors.
Tint	Tint is only active for Video and S-Video when using the NTSC 4.43 or NTSC 3.58 system. Use the + button for more tint Use the - button for less tint.
Sharpness	The sharpness function is used to adjust the image sharpness of video signals. Use the + button for more sharpness Use the - button for less sharpness
Phase	Use the + or - side of the phase control button to adjust the phase.

The Pause Key

When the Pause key is pressed, the image projection is stopped, a black screen will be displayed and the projector remains with full power for immediate restart. The 7-segment display on the projector will show a "P". The shutter is closed.

To restart the image, press one of the following keys:

- Press **Pause** key.
- Select a source number.

The Stand-by Key

When the Stand-by key is pressed, the image projection is stopped and the projector goes to stand-by. This situation is used when a projection stop is planned for a longer period. All custom settings are saved to an internal backup device. A message 'Save data ...' is displayed during this backup operation.

The Freeze key

When pressing for 5 seconds on the Freeze button, the projector goes to stand-by. This function is very useful when multiple projectors have to be switched to stand-by. Set the RCU address to the common address and press Freeze for 5 seconds. All projectors go to stand-by without the risk of restart.

When pressing shortly on Freeze, the current image is frozen.

7. START UP OF THE ADJUSTMENT MODE

Overview

- About the adjustment mode
- About the use of the remote control and the local keypad
- Start up the adjustment mode
- Navigation and adjustments
- Shortcut keys to the menus
- On screen menus versus LCD display menus
- Test patterns in adjustment mode
- Menu memory

7.1 About the adjustment mode

Overview

As the adjustment mode is the central place to control and align the projector, the following functions can be done:

- Input setup: the different inputs can be configured for a specific format or input source.
- Image adjustment: these adjustments are organized per image source and contain the aspect ratio, timings and image settings.
- Layout adjustment: set up of the main window and the picture in picture window.
- Lamp: manage the lamp mode, the lamp use, lamp type and history
- Alignment: groups all controls necessary during the setup of the projector onto a screen.
- Projector control: contains the accessibility settings of the projector, such as address and communication setup.
- Service: contains information about how the projector is performing. This information will be useful when calling for a service intervention.

7.2 About the use of the remote control and the local keypad

Overview

All navigations and adjustments can be done either with the remote control or with the local keypad.

Almost all the keys on the remote control have an equivalent on the local keypad.

Exceptions:

- ▲ on the remote control corresponds with the up + key on the local keypad.
- ▼ on the remote control corresponds with the down - key on the local keypad.
- ◀ on the remote control corresponds with the left - key on the local keypad
- ▶ on the remote control corresponds with the right + key on the local keypad

7.3 Start up the adjustment mode

Start up tools

To start up the adjustment mode, use the remote control or the local keypad.

How to start up?

1. Press **Menu** on the remote control (RCU) or on the local keypad to start up the *Adjustment* mode.

7. Start up of the Adjustment Mode

The main menu of the adjustment mode opens.



Image 7-1

7.4 Navigation and adjustments

How to navigate in the menu structure?

Once in the menu structure, use the ▲ or ▼ keys on the remote control (or the ▲ or ▼ (+ or -) key on the local keypad) to scroll through the items in the displayed menu. The selected item will get a background color. To activate a selected submenu or function, press **ENTER**.

When on a submenu, to return one step to the parent menu, press **EXIT**.

To escape the menu structure when on a menu, press **MENU**.

How to make an adjustment?

With the remote control, press the ▲ or ▼ keys until the desired value (setup) is reached. Press **EXIT** to finalize the adjustment.

With the local keypad, press the ▲ or ▼ (+ or -) keys until the desired value (setup) is reached. Press **EXIT** to finalize the adjustment.

All adjustments will be indicated with an on-screen box with the name of the adjustment in the title bar, the length of the progress bar indicates the actual value. The value at the start and at the end of the progress bar indicates the adjustment ranges.

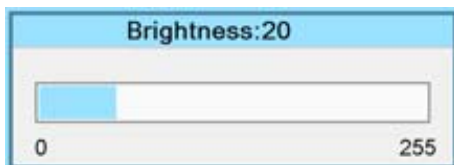

Image 7-2

While a bar scale is displayed, it is also possible to enter the desired value directly with the digit keys. Therefore, press **ENTER**. The menu changes to a *Enter new value* menu with the current value filled out. The first digit is selected.

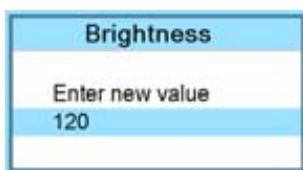

Image 7-3

Use the ◀ or ▶ key to jump to the next digit or enter a new value for the selected digit with the digit keys and then the selection will jump also to the next digit. Repeat this action for all other digits and press **ENTER** to finalize the input.

If applicable in direct input, toggle between + and - with the left arrow key (◀).

7.5 Shortcut keys to the menus

About a shortcut key

The digit keys 5 to 9 can be customer programmed to directly open a pre-stored menu. That menu can be any independent menu out of the list of menu. A menu which is built up by the content of a previous menu cannot be stored behind a shortcut.

How to use a shortcut key

While in the operational mode, no menu selected, just press on the desired digit key to open the menu behind that shortcut key.

How to create a shortcut key

Scroll to the desired menu. Press the digit key behind which the menu must be stored for 5 seconds. When the creation is successfully, a confirmation message appears on the screen. E.g. :

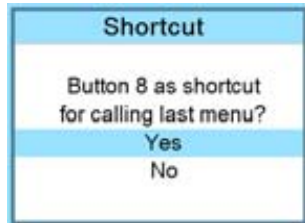

Image 7-4

Select **Yes** to confirm the creation.



To erase the shortcut, navigate to *Projector Control* → *Buttons*.

7.6 On screen menus versus LCD display menus

Overview

As the projector is equipped with an 8 lines LCD panel, the on-screen menus are also displayed on that LCD panel in the same structure as the on screen menus. These menus can be used in the same way as the on-screen menus.

The menus on the LCD panel are still reachable even when the projector lamp is not activated and when Text is in the off mode.

When quitting the menu structure, the backlighting of the LCD panel is switched off after a few seconds.

7.7 Test patterns in adjustment mode

Overview

When the adjustment mode is started, a test pattern can be called at any moment just by pressing the **Pattern** key on the RCU or the local key path. Press as many times on the **Pattern** key as necessary to display the desired test pattern. The test pattern remains on the screen as long as the adjustment mode is selected, even when selecting other menus. When leaving the adjustment mode, the selected test pattern is cleared and the normal image is displayed again.

7.8 Menu memory

Overview

Each menu with sub menus, remembers its last selected sub item even when leaving the menu structure and that as long as the projector is running. When restarting the projector from stand-by, the menu memory is reset.

After re-opening the main menu and selecting an item, the previous selected sub item of that selected item is highlighted and can be opened just by pressing **ENTER**.

8. INPUT MENU

Overview

- Overview flow
- Slot module type
- Input locking
- Minimum delay
- Native resolution
- Source switching
- No signal

8.1 Overview flow

Overview

Level 1	Level 2	Level 3
Input		
	Slot module type	5-cable HD-SDI - SDI DVI DVI HDCP
	Input locking	Free running Automatic Input 1 to 4
	Minimum delay [On/Off]	
	Native resolution [On/Off]	
	Source switching	Effect Effect time
	No signal	Color [black/blue] Shutdown [Off/On] Shutdown time

8.2 Slot module type

Overview

- About Input Setup
- Input configuration

8.2.1 About Input Setup

Overview

Each input module must be configured before these module can be used. This configuration is necessary so that the projector knows which type of signal is connected to its input.

The projector has 4 input slots and these slots can be filled up in a random order with the available modules. Identical modules are allowed.

For more information about the available input modules and how to install, see "Input source connections", page 37.



CAUTION: Always install a cover plate on an unused input slot. This to prevent dust intrusion into the projector.

8.2.2 Input configuration

How to change?

1. Press **MENU** to activate the menus.
2. Use the **▲** or **▼** key to select *Input* and press **ENTER**.
The Input menu is displayed.
3. Use the **▲** or **▼** key to select *Slot module type* and press **ENTER**.
The slot overview window is displayed with the actual situation filled out.
4. Use the **▲** or **▼** key to select a slot.
Press **ENTER** to open the selection menu which will be different from input type to input type (except for DVI, see DVI equalization).

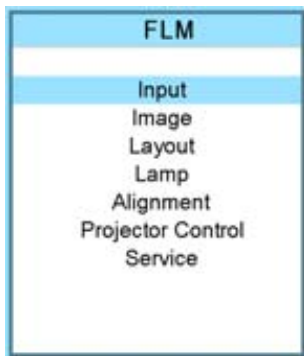

Image 8-1

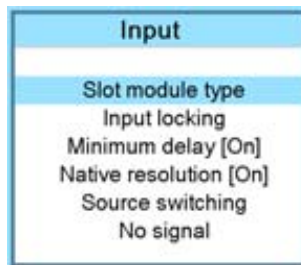

Image 8-2

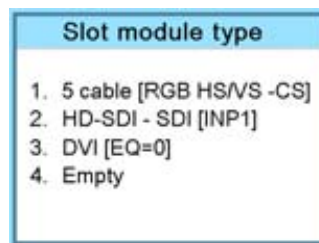

Image 8-3

For a 5 cable module

When **ENTER** is pressed on a 5 cable module, the following menu appears:

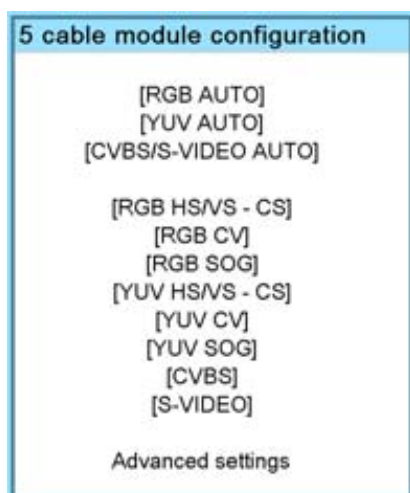

Image 8-4

Use the **▲** or **▼** key to select the desired configuration and press **ENTER** to select.

When e.g. RGB AUTO is selected, the projector discovers itself which type of RGB signal is connected to it and loads the correct settings.

For RGB selections, advanced settings are possible. To adjust these advanced settings, use the **▲** or **▼** key to select *Advanced settings* and press **ENTER**. The advanced settings menu opens:

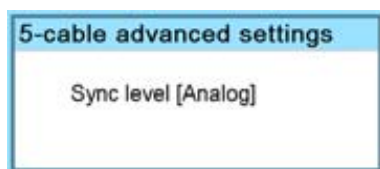

Image 8-5

Press **ENTER** to toggle between [Analog] and [TTL].

For a HDSI - SDI module

When **ENTER** is pressed on a HDSI or SDI module, the following menu appears:

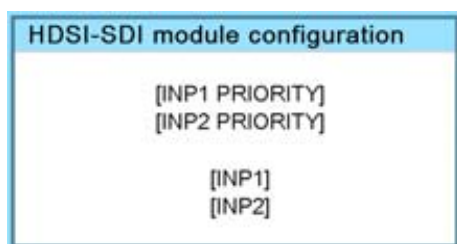

Image 8-6

Use the **▲** or **▼** key to select the desired configuration and press **ENTER** to select.

When an input with priority is selected, then if a signal is connected to both inputs the input indicated has the priority. If there is no signal on the priority input, the signal of the other input is displayed.

DVI equalization

When a DVI module (DVI or DVI HDCP) is selected, press **ENTER** to go in edit mode. Use **◀** or **▶** to key to change the equalization value.

Default value = 13.

For non DVI-compliant transmitter, stronger equalization may be necessary even for shorter cables.

For longer cables adjust between 0 and 13 (more equalization).

For shorter cables adjust between 13 and 15 (least equalization).

8.3 Input locking

What is possible?

The output signal can be locked on an internal sync signal or on the sync signal of one of the input sources. Input locking can avoid that some windows in the output signal are slowly moving or trembling.

When automatic is selected, the lock will be set on the input signal of the main window.

How to set up?

1. Press **MENU** to activate the menus.
2. Use the **▲** or **▼** key to select *Input* and press **ENTER**.
The Input menu is displayed.
3. Use the **▲** or **▼** key to select *Input locking* and press **ENTER**.
The input locking window is displayed. The actual selected locking method is indicated by an arrow.
4. Use the **▲** or **▼** key to select the desired locking and press **ENTER**.

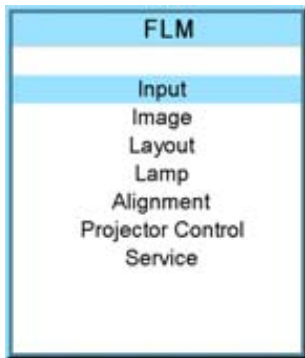

Image 8-7

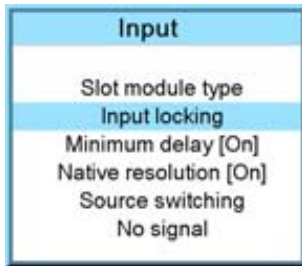

Image 8-8

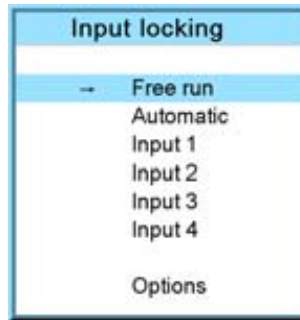

Image 8-9

When:

Free run	Output is locked on an internal sync (60 Hz)
Automatic	Output is locked on the selected input for the main window
Input 1	Output is locked on source 1
Input 2	Output is locked on source 2
Input 3	Output is locked on source 3
Input 4	Output is locked on source 4

The options menu changes depending on the selection.



When Input locking is set to Automatic or on a specific input and there is no sync signal available, the locking will be switched to Free run without changing the user settings. Once the sync is available, it applies again the user settings.

Options for Free run

When *Free run* is selected (arrow in front of it) and then the *Options* are selected, the following menu appears:

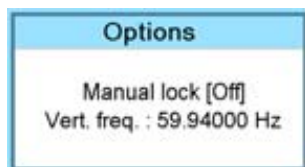

Image 8-10

Use the ▲ or ▼ key to select *Manual lock* and press **ENTER** to toggle between *On* and *Off*.

Manual lock on : locking is done on the indicated vertical frequency which can be changed by the user.

Manual lock off : locking is done on an internal sync (60 Hz).

To change the locking frequency for manual lock on, use the ▲ or ▼ key to select *Vert freq* and press **ENTER** to activate. The first digit is selected.

Use the ▲ or ▼ key to select the desired digit and press ◀ or ▶ key to select the next digit in the address or enter the value with the digit keys on the remote control or local keypad. The next digit in the value will be automatically selected.

Options for Automatic or specific input

When *Automatic* or specific input is selected (arrow in front of it) and then the *Options* are selected, the following menu appears:

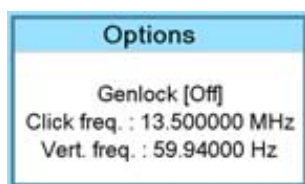

Image 8-11

Use the ▲ or ▼ key to select *Genlock* and press **ENTER** to toggle between *On* and *Off*.

- Genlock off (default position) locking done on input source of main window, when automatic was selected or on the selected input source when a specific input was selected. Projector detects automatically the vertical frequency and clock frequency of the input signal. A slightly difference with the source is possible.
- Genlock on locking done on indicated vertical frequency and clock frequency. This vertical frequency and clock frequency must be exactly the same as those of the source.
- Only use genlock ON for very stable sources and preferable for broadcast sources.

For Genlock on,

to change the locking frequency, use the ▲ or ▼ key to select *Vert freq* and press **ENTER** to activate. The first digit is selected.

Use the ▲ or ▼ key to select the desired digit and press ◀ or ▶ key to select the next digit in the address or enter the value with the digit keys on the remote control or local keypad. The next digit in the value will be automatically selected.

to change the clock frequency, use the ▲ or ▼ key to select *Clock freq* and press **ENTER** to activate. The first digit is selected.

Use the ▲ or ▼ key to select the desired digit and press ◀ or ▶ key to select the next digit in the address or enter the value with the digit keys on the remote control or local keypad. The next digit in the value will be automatically selected.



For older custom files, created with software packages older than package 1.5.6, the Genlock function will be grayed out. If you want to use this genlock function, a new custom file must be created starting from the standard file. Copying the custom file in a new file do not solve this issue.

8.4 Minimum delay

Purpose

In normal mode, the processing (scaling and de-interlacing) in DLP projectors introduces a few frames delay (from input to screen). Setting the option *Minimum Delay* to "ON" disables all scaling and de-interlacing in the processing and reduces frame delay of the projector (from input to screen) to ONE frame, caused by the formatter board (DLP technology restriction). The intended use of this option is to apply native and progressive data to the projector and displaying it with minimum delay, using the full resolution of the projector. Other formats will be displayed either unscaled and/or interlaced.

This feature can be used if additional delay in the projector is not acceptable. For instance if a projector is showing the DVI loop out of another DLP or if an external scaler/de-interlacer does the processing.

How to toggle the delay?

1. Press **MENU** to activate the menus.
2. Use the ▲ or ▼ key to select *Input* and press **ENTER**.
The Input menu is displayed.
3. Use the ▲ or ▼ key to select *Minimum delay* and press **ENTER** to toggle between [On] and [Off].

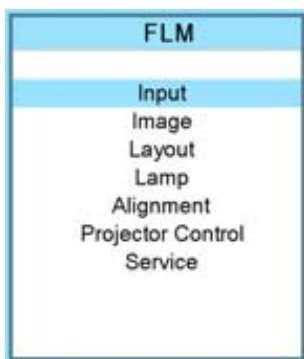

Image 8-12

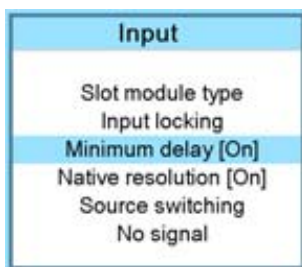

Image 8-13

8.5 Native resolution

What can be done

The aim here is to always show the resolution of the source independently of the resolution of the DMD panels.

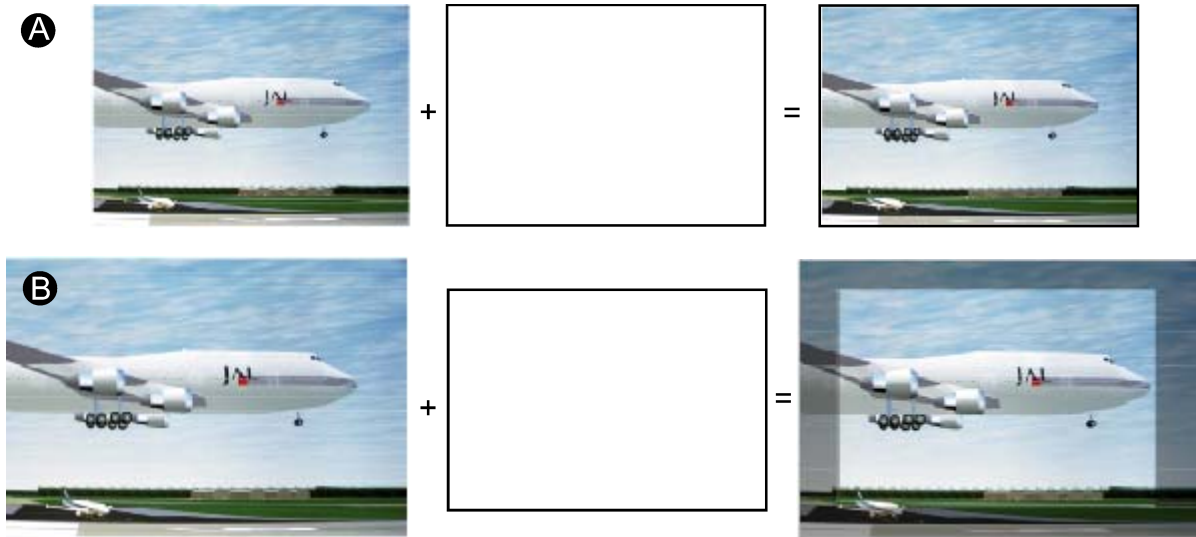

Image 8-14

When the *show native resolution* function is in the ON position, the projector handles the source as follows:

Source			Projected image		
Name	Ratio	Resolution	Ratio	Resolution	
XGA	4:3	1024x768	4:3	1024x768	image projected with black borders
SXGA	5:4	1280x1024	5:4	1280x1024	image projected with black borders
SXGA+	4:3	1400x1050	4:3	1400x1050	normal image projected
UXGA	4:3	1600x1200	4:3	1600x1200	part of the image displayed, image scroll possible

How to toggle to native resolution?

1. Press **MENU** to activate the menus.
2. Use the **▲** or **▼** key to select *Input* and press **ENTER**.
The Input menu is displayed.
3. Use the **▲** or **▼** key to select *Native resolution* and press **ENTER** to toggle between [On] and [Off].
[On] : images displayed in native resolution
[Off] : images scaled to fill the complete screen

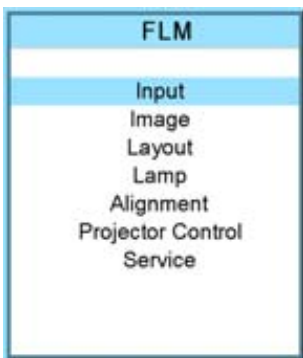

Image 8-15

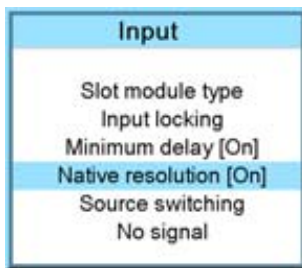

Image 8-16



When native resolution is on, some other menus such as *Aspect ratio*, *timings* are greyed out.

8.6 Source switching

Switching from one source to another

To minimize undesired effects when switching from one source to another one can use the switching mode, using the fade effect.



Image 8-17
Example of fade effect

Switching mode set up

1. Press **MENU** to activate the menus.
2. Use the **▲** or **▼** key to select *Input* and press **ENTER**.
The Input menu is displayed.
3. Use the **▲** or **▼** key to select *Source switching* and press **ENTER**.
The Source switching menu is displayed.
4. Use the **▲** or **▼** key to select *Effect* and press **ENTER** to toggle between *No transition* and *Fade*.
No transition No source switching effect is activated.
Fade Fade in, fade out effect is activated. Transition time can be set up.
5. Use the **▲** or **▼** key to select *Effect time* and press **ENTER**.
6. Enter the desired time with the digit keys
Or,
use the **▲** or **▼** key to scroll until the desired time is reached. Press **ENTER** to activate.

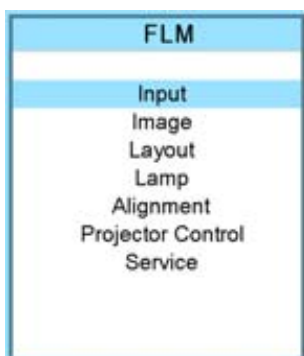

Image 8-18

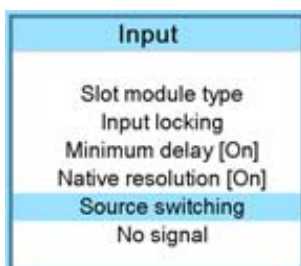

Image 8-19

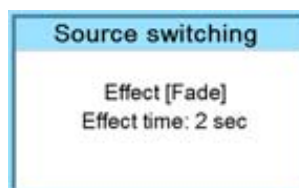

Image 8-20

8.7 No signal

Overview

- Background color
- Shutdown setting
- Shutdown retarding time

What can happen when no signal

When no signal available, a blue or black background color can be displayed or the projector can be shutdown with a certain retarding time.

8.7.1 Background color

How to change the color

1. Press **MENU** to activate the menus.

8. Input menu

2. Use the ▲ or ▼ key to select *Input* and press **ENTER**.

The Input menu is displayed.

3. Use the ▲ or ▼ key to select *No signal* and press **ENTER** to toggle between [Black] and [Blue].

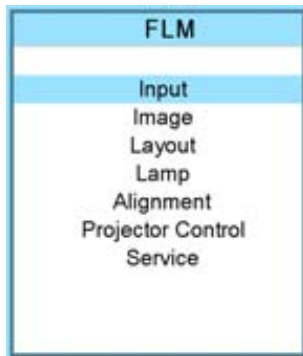

Image 8-21

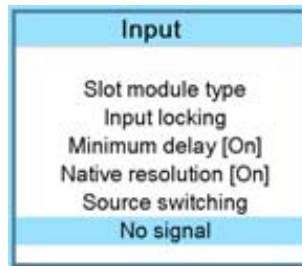

Image 8-22

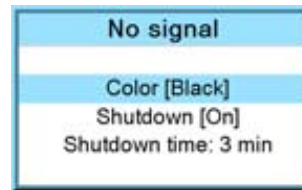

Image 8-23

8.7.2 Shutdown setting

How to change the shutdown setting

1. Press **MENU** to activate the menus.

2. Use the ▲ or ▼ key to select *Input* and press **ENTER**.

The Input menu is displayed.

3. Use the ▲ or ▼ key to select *Shutdown* and press **ENTER** to toggle between [On] and [Off].

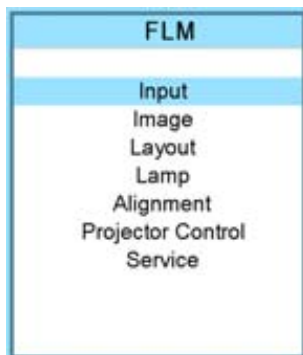

Image 8-24

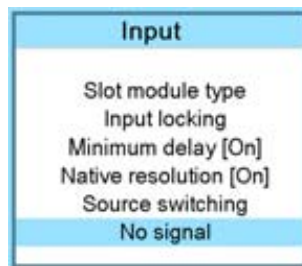

Image 8-25



Image 8-26

8.7.3 Shutdown retarding time



Only accessible when *Shutdown* is set to [On].

How to set the retarding time?

1. Press **MENU** to activate the menus.

2. Use the ▲ or ▼ key to select *Input* and press **ENTER**.

The Input menu is displayed.

3. Use the ▲ or ▼ key to select *Shutdown time* and press **ENTER**.

4. Use the ▲ or ▼ key to change the value.

Or,
enter the desired value with the keyboard.

When trying to exceed the maximum allowed value, the system will set it back to the maximum value.

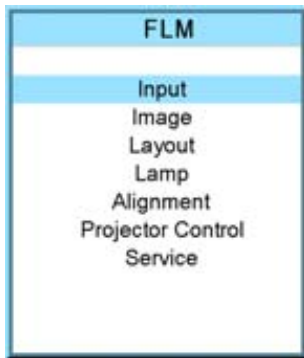

Image 8-27

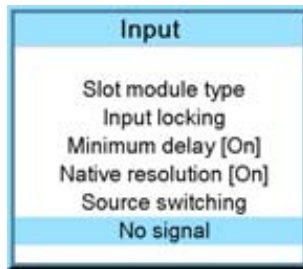

Image 8-28

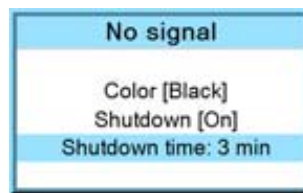

Image 8-29

9. IMAGE MENU

Overview

- Overview flow
- How to select the image adjustments?
- Image Settings
- Aspect ratio
- Timings
- Image files services
- Save custom settings

9.1 Overview flow

Overview

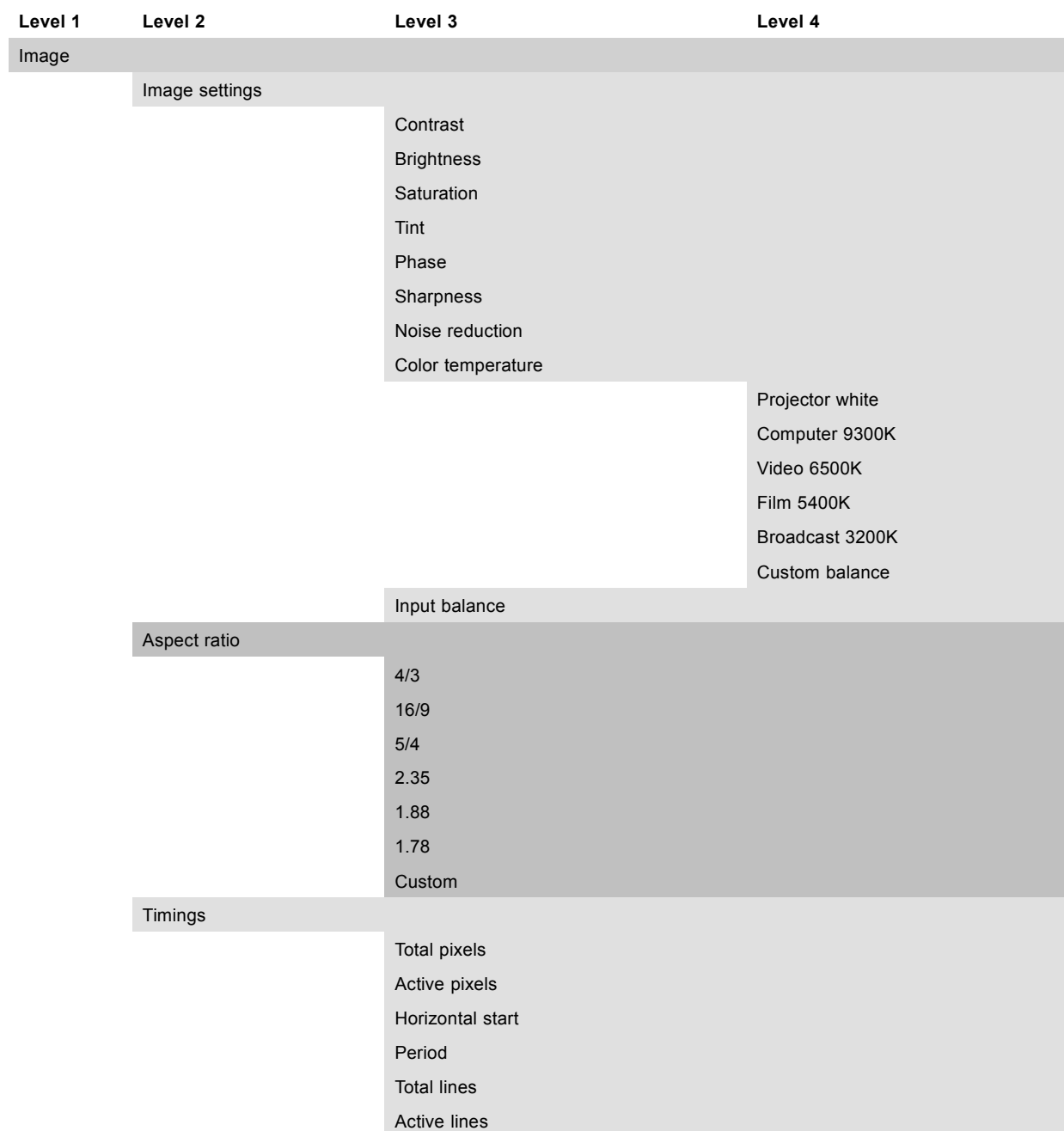

9. Image menu

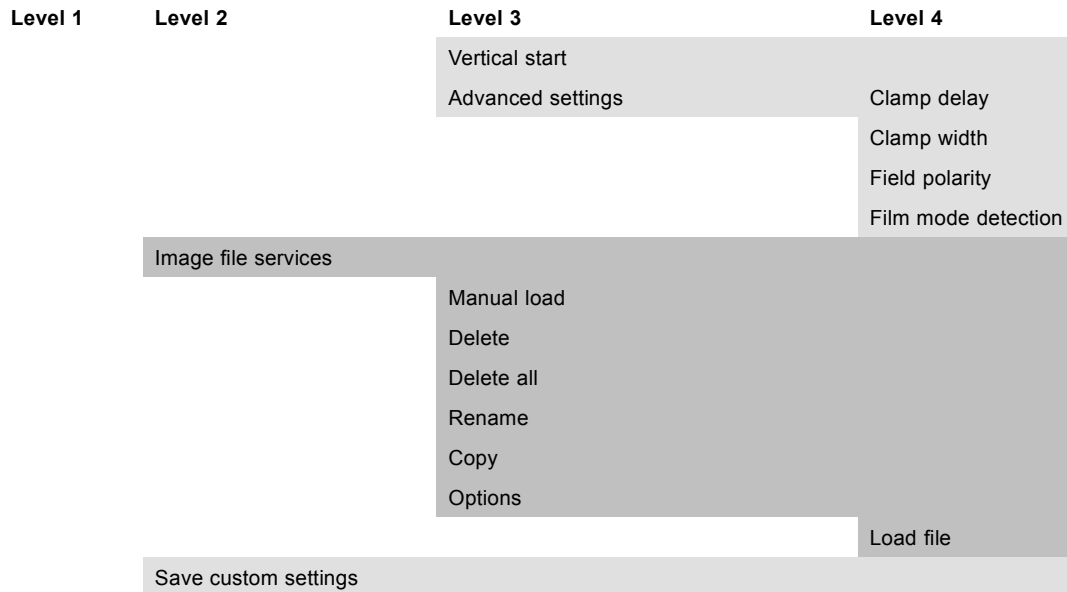

9.2 How to select the image adjustments?

Start up

1. Use the ▲ or ▼ key to select *Image*.
2. Press **ENTER** to select.

The *Image* menu opens.

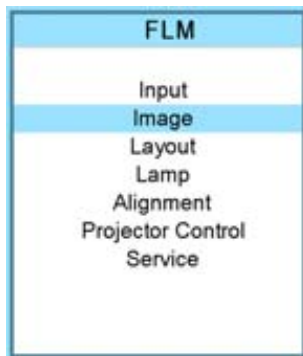

Image 9-1



Image 9-2

9.3 Image Settings

Overview

- Contrast
- Brightness
- Saturation
- Tint (hue)
- Phase
- Sharpness
- Noise reduction
- Color temperature
- Input balance

9.3.1 Contrast

About Contrast

The contrast function is used to adjust the contrast between the light and dark areas of the displayed image.

How to change the contrast?

1. Press **MENU** to activate the menus.
2. Use the **▲** or **▼** key to select *Image* and press **ENTER**.
3. Use the **▲** or **▼** key to select *Image settings* and press **ENTER**.
4. Use the **▲** or **▼** key to select *Contrast* and press **ENTER**.

The Contrast progress bar appears.

5. Use **◀** or **▶** to change the contrast.

The higher the value, the higher the contrast.

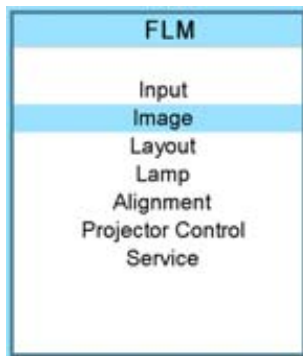

Image 9-3



Image 9-4

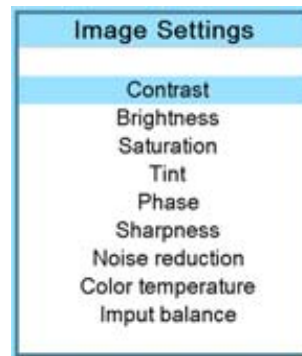

Image 9-5

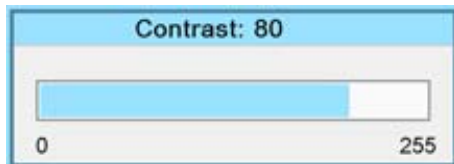

Image 9-6

9.3.2 Brightness

About Brightness

The Brightness function is used to adjust the overall light output.

How to change the brightness?

1. Press **MENU** to activate the menus.
2. Use the **▲** or **▼** key to select *Image* and press **ENTER**.
3. Use the **▲** or **▼** key to select *Image settings* and press **ENTER**.
4. Use the **▲** or **▼** key to select *Brightness* and press **ENTER**.

The Brightness progress bar appears.

5. Use **◀** or **▶** to change the brightness.

9. Image menu

The higher the value, the higher the brightness.

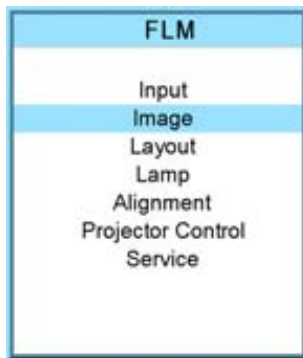

Image 9-7



Image 9-8

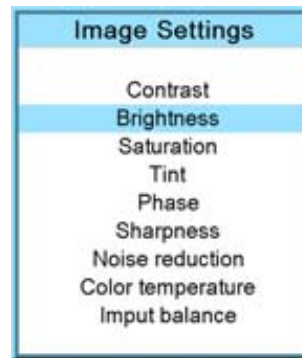

Image 9-9

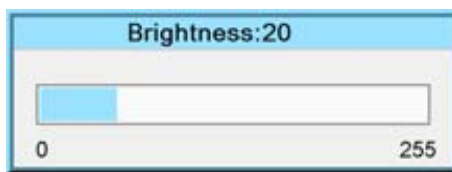

Image 9-10

9.3.3 Saturation

About (color) saturation

The color function is used to adjust the color saturation levels.

How to change the saturation?

1. Press **MENU** to activate the menus.
2. Use the **▲** or **▼** key to select *Image* and press **ENTER**.
3. Use the **▲** or **▼** key to select *Image settings* and press **ENTER**.
4. Use the **▲** or **▼** key to select *Saturation* and press **ENTER**.

The Saturation progress bar appears.

5. Use **◀** or **▶** to change the color saturation.

The higher the value, the higher the color saturation.

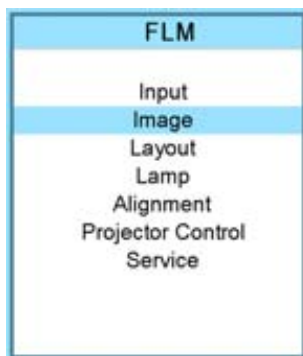

Image 9-11



Image 9-12

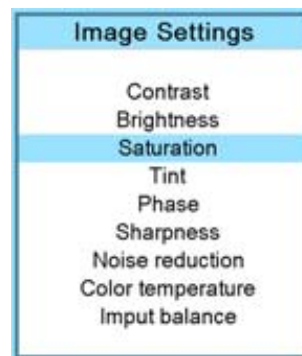

Image 9-13

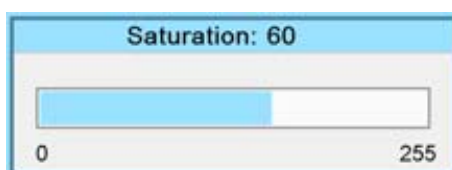

Image 9-14

9.3.4 Tint (hue)

About Tint

The Tint function is used to adjust color hue to obtain true color reproduction and is only active for Video and S-Video when the NTSC color system is used. For PAL and SECAM sources, Tint is not accessible.

How to change the saturation?

1. Press **MENU** to activate the menus.
2. Use the **▲** or **▼** key to select *Image* and press **ENTER**.
3. Use the **▲** or **▼** key to select *Image settings* and press **ENTER**.
4. Use the **▲** or **▼** key to select *Tint* and press **ENTER**.

The Tint progress bar appears.

5. Use **◀** or **▶** to change the tint.

The higher the value, the higher the tint.

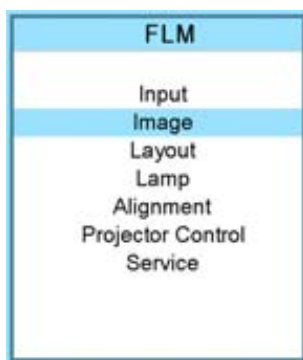

Image 9-15



Image 9-16

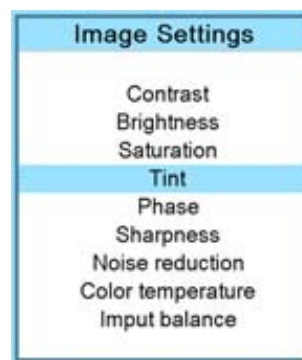

Image 9-17

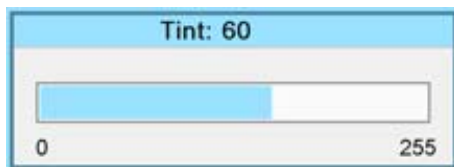
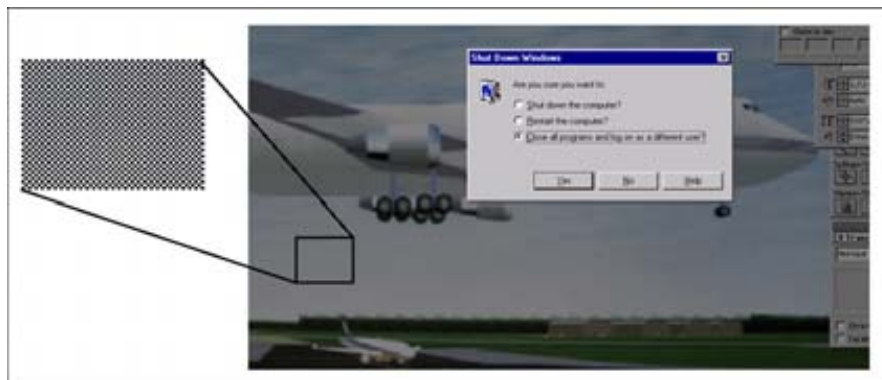

Image 9-18

9.3.5 Phase

About Phase adjustment

When displaying computer patterns or graphics (RGB or YUV signals) which are very detailed (tilting, vertical stripes, etc.), jitter in picture (mis-sampling) may occur, causing horizontal stripes in portions of the screen. When this jitter occurs, adjust 'Phase' for optimum image.

Image 9-19
Jittering on image

How to change the phase?

1. Press **MENU** to activate the menus.
2. Use the **▲** or **▼** key to select *Image* and press **ENTER**.
3. Use the **▲** or **▼** key to select *Image settings* and press **ENTER**.
4. Use the **▲** or **▼** key to select *Phase* and press **ENTER**.

The Phase progress bar appears.

5. Use **◀** or **▶** to change the phase and refine the jitter.

Note: Don't mix up with wrong number of total pixels. If the jitter doesn't disappear with the phase adjustment, check the total number of pixels. (Best image = pixel on pixel off pattern. For example: shut down screen of a PC)

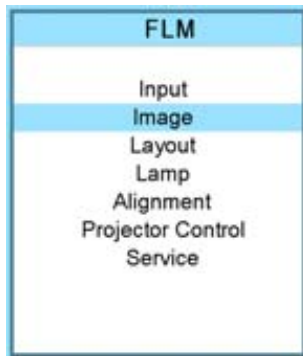

Image 9-20



Image 9-21

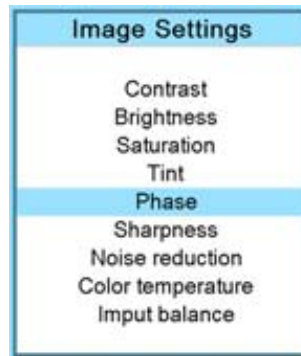

Image 9-22

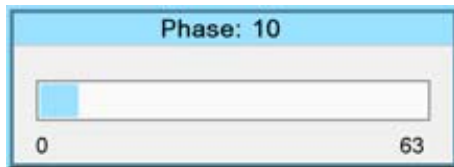

Image 9-23

9.3.6 Sharpness

About Sharpness

The sharpness function is used to adjust the image sharpness of video signals.

How to change the sharpness?

1. Press **MENU** to activate the menus.
2. Use the **▲** or **▼** key to select *Image* and press **ENTER**.
3. Use the **▲** or **▼** key to select *Image settings* and press **ENTER**.
4. Use the **▲** or **▼** key to select *Sharpness* and press **ENTER**.

The Sharpness progress bar appears.

5. Use **◀** or **▶** to change the sharpness.

The higher the value, the higher the sharpness.

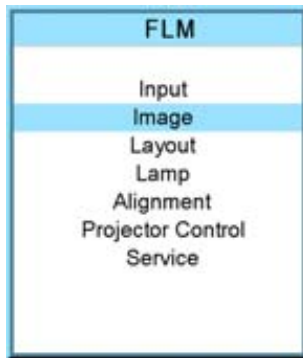

Image 9-24



Image 9-25

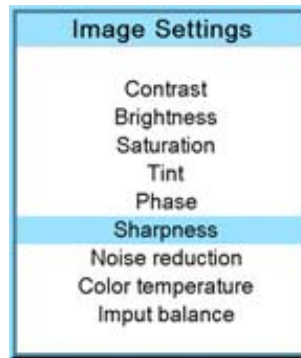

Image 9-26



Image 9-27

9.3.7 Noise reduction

About Noise reduction

Reduces noise and pixel jitter in all video sources.

How to change?

1. Press **MENU** to activate the menus.
2. Use the **▲** or **▼** key to select *Image* and press **ENTER**.
3. Use the **▲** or **▼** key to select *Image settings* and press **ENTER**.
4. Use the **▲** or **▼** key to select *Noise reduction* and press **ENTER**.

The Noise reduction progress bar appears.

5. Use **◀** or **▶** to change the noise reduction.

The higher the value, the higher the noise reduction.

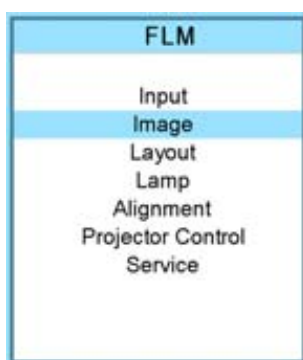

Image 9-28



Image 9-29

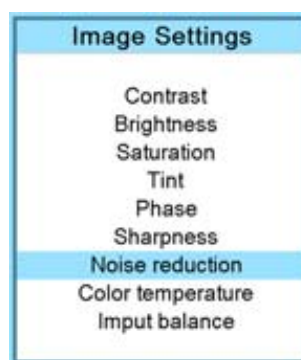

Image 9-30

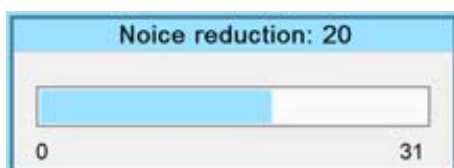

Image 9-31

9.3.8 Color temperature

What can be done ?

The color temperature can be selected according to the type of source:

There are 5 different preset color temperatures:

- Projector white
- computer : 9300 K
- Video : 6500 K
- Film : 5400 K
- Broadcast : 3200 K

These calibrated presets can be selected and will provide optimum color tracking, the projector allows however the setting of a personal color temperature, this is done in *custom balance*



Color temperature selection is only possible when Color space is OFF



Color temperature

The coloration (reddish, white, bluish, greenish, etc.) of white in an image, measured using the Kelvin (degrees K) temperature scale. Higher temperatures output more light.

9.3.8.1 Predefined color temperature



Projector white will provide maximum projector light output. The calibrated 'Broadcast', 'Film', 'Video' and 'Computer' presets will provide optimum color tracking.

How to select?

1. Press **MENU** to activate the menus.
2. Use the **▲** or **▼** key to select *Image* and press **ENTER**.
3. Use the **▲** or **▼** key to select *Image settings* and press **ENTER**.
4. Use the **▲** or **▼** key to select *Color temperature* and press **ENTER**.
5. Use the **▲** or **▼** key to select a predefined color temperature value, e.g. Video, and press **ENTER**.

The colors of the image is switched to the selected value.

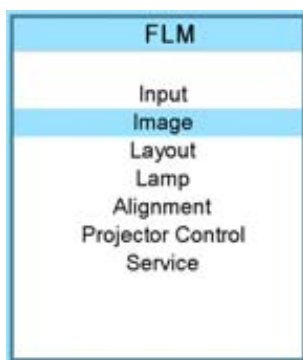

Image 9-32



Image 9-33

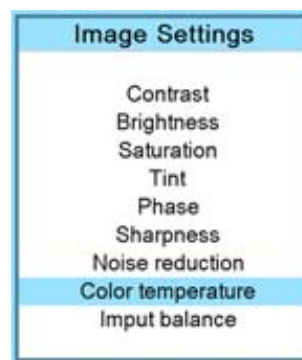

Image 9-34

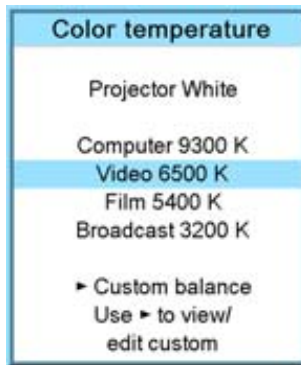

Image 9-35

9.3.8.2 Set a custom color temperature

How to enter a custom value?

1. Press **MENU** to activate the menus.
2. Use the **▲** or **▼** key to select *Image* and press **ENTER**.
3. Use the **▲** or **▼** key to select *Image settings* and press **ENTER**.
4. Use the **▲** or **▼** key to select *Color temperature* and press **ENTER**.
5. Use the **▲** or **▼** key to select *Custom balance* and press **▶**.

The Gain adjustment bar scales are displayed.

6. Adjust gain red with **◀** or **▶** key and gain blue with **▲** or **▼** key. Adjust gain blue in the same way as gain red.
7. When gain adjustment is finished press **ENTER**.

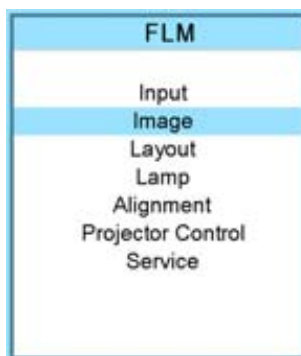

Image 9-36



Image 9-37

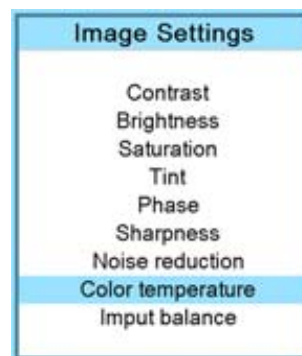

Image 9-38

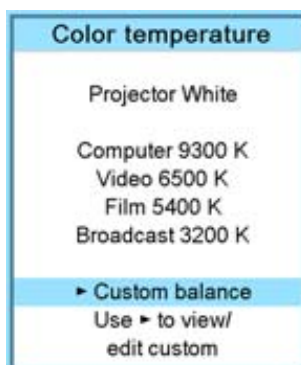

Image 9-39



Image 9-40

9.3.9 Input balance

Overview

- Introduction to Input Balance
- Adjusting the input balance

9.3.9.1 Introduction to Input Balance

Introduction: Unbalanced color signals

When transporting signals, there is always a risk of deterioration of the information contained in the signals.

In case of information contained in the amplitude of the signals which is the case of data color signals (R, G, B), image 9-41, we are quite sure that the amplitude of these color signals is subject to alterations.

An example of alteration may be a DC component added to the signal, in the form of a DC offset repositioning the black level, since this **black level** (“**brightness**”) will become crucial later on (clamping circuit) it will result in “black not being black”.

Another value that is subject to alteration is the amplitude of the signal, resulting in an altered “Gain” of the signal (“**white level**” or **contrast**).

The alterations of the three color signals will happen independently i.e. the colors will end to be unbalanced, image 9-42

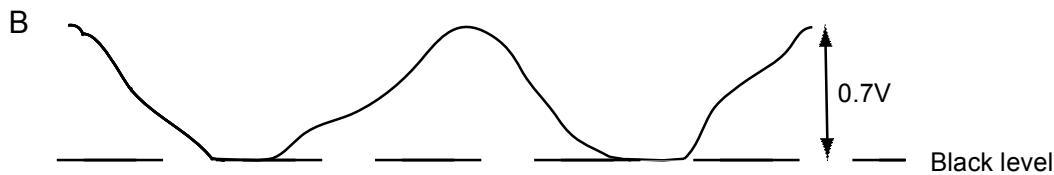

Image 9-41

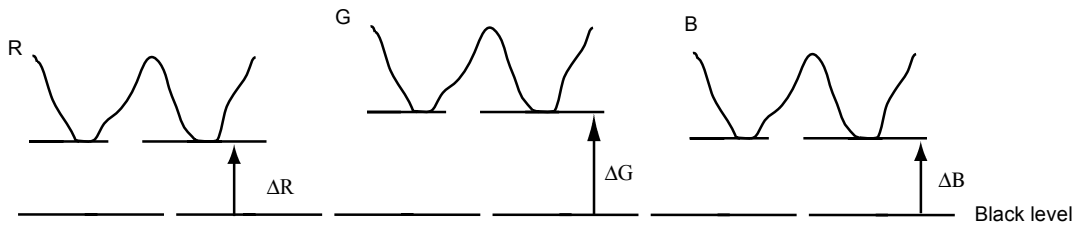

Image 9-42



One can conclude here that a good color tracking can only be met by using three previously (input) balanced color signals

Analog Digital Conversion

The analog color signals must pass through an Analog/Digital conversion circuit prior to any digital processing in the PMP.

A typical ADC transforms the analog value into an 8 bit coded digital signal.

The graphic shows that when converting a signal containing a DC offset component the range of the converter is not optimally used.

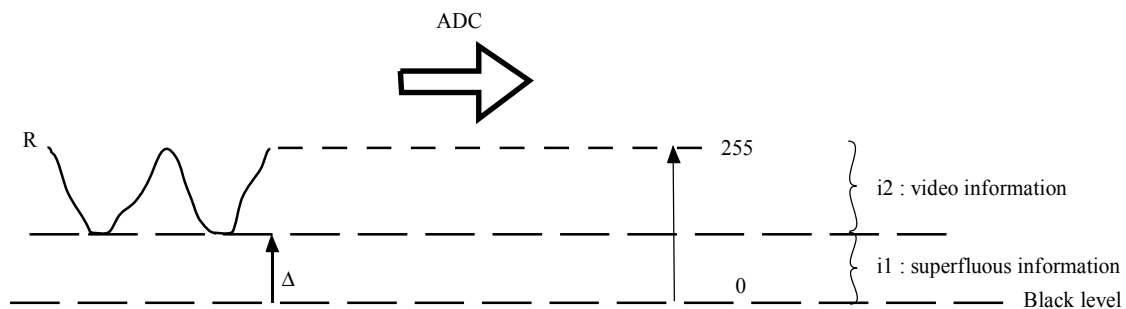

Image 9-43



One can conclude here that a good data conversion can only be met by using three previously (input) balanced color signals

The objective of input balancing

The objective in input balancing is to “set” the same black level and the same white level for the three colors of a particular input source.



Black level setting : brightness

White level setting : contrast

The same absolute black and white level for the three colors allows the same reference for Brightness and Contrast control of the picture !

These two references also set the range in which the ADC will work for that particular source (this explains also why each input balance setting is linked to a particular source and thus saved in the image file).

9.3.9.2 Adjusting the input balance

How can it be done ?

To balance the three color signals of a particular source there are conditions; in fact we must know the black and the white level of the source i.e. :

1. The source in question must be able to generate a white signal, ideally a 100% white (background) full screen pattern
2. The source in question must be able to generate a black signal, ideally a 100% black (background) full screen pattern

A



B

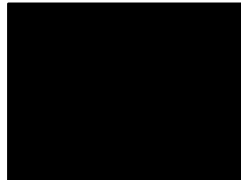

Image 9-44

White balance : In the projector, we will set the contrast for each color until we get a 100% light output picture when projecting a 100% white image (image A)

Black balance : In the projector, we will set the brightness for each color until we get a 0% light output picture when projecting a 100% black image (image B).



The changeover from min to max is indicated by the apparition of bright spots also called “digital noise”



An alternative to a full screen White/black pattern is the standard gray scale pattern, the white bar will be used for white balance and the black bar for black balance.

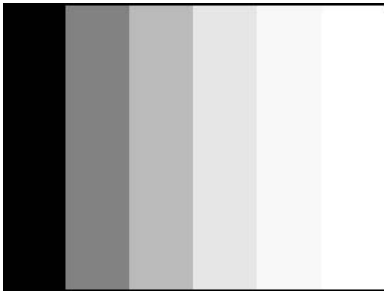

Image 9-45

Black balance

1. Press **MENU** to activate the menus.
2. Use the **▲** or **▼** key to select *Image* and press **ENTER**.
3. Use the **▲** or **▼** key to select *Image settings* and press **ENTER**.
4. Use the **▲** or **▼** key to select *Input balance* and press **ENTER**.
5. Do you want to use an internally generated test pattern ?
If yes, Use the **▲** or **▼** key to select *Test pattern* and press **ENTER** to toggle between [on] and [off]
If no, Adjust on the selected source.
6. Use the **▲** or **▼** key to select *Black balance* and press **ENTER**.
Depending whether a test pattern is selected or not, the adjustment image is displayed.
7. Toggle with **▲** or **▼** key to select *Black balance red*.

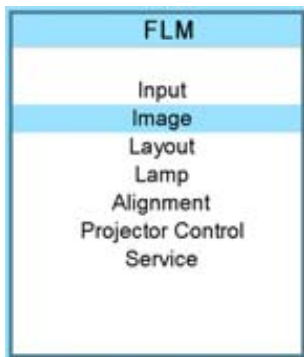

Image 9-46



Image 9-47

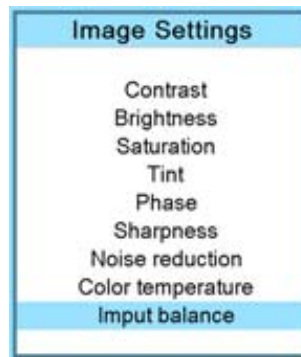

Image 9-48

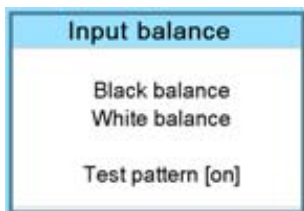

Image 9-49

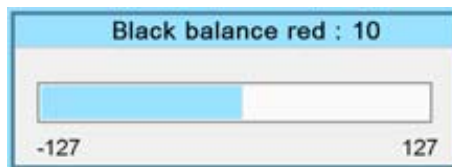

Image 9-50

8. Adjust the red black level on a minimal value
9. Toggle with **▲** or **▼** key to *Black balance blue* and adjust the blue black level on a minimal value.
Note: This minimal value is not necessary, provided that the 2 other colors are not influencing too much the color to be adjusted, in fact the aim is to minimize the effect of the two other colors since there is a risk of reaching too soon the 50% transition due to the contribution of these two other colors signals.
10. Toggle with **▲** or **▼** key to *Black balance green* and adjust the Green black level until bright spots appear on the screen.
11. Toggle with **▲** or **▼** key to *Black balance blue* adjust the Blue black level until bright spots appear on the screen.
12. Toggle with **▲** or **▼** key to *Black balance red* adjust the Red black level until bright spots appear on the screen.

The projected image should now be noisy full black



If one uses a gray scale pattern, the bright spots should appear in the black bar.

Performing White input balance

1. Connect the source you want to project.
2. Press **MENU** to activate the menus.
3. Use the **▲** or **▼** key to select *Image* and press **ENTER**.
4. Use the **▲** or **▼** key to select *Image settings* and press **ENTER**.
5. Use the **▲** or **▼** key to select *Input balance* and press **ENTER**.
6. Do you want to use an internally generated test pattern?
If yes, Use the **▲** or **▼** key to select *Test pattern* and press **ENTER** to toggle between [on] and [off]
If no, select a white pattern (or gray scale as alternative).
7. Use the **▲** or **▼** key to select *White balance* and press **ENTER**.
The white balance bar scale for a typical color is displayed.
8. Toggle with the **▲** or **▼** key to select *White balance red*.

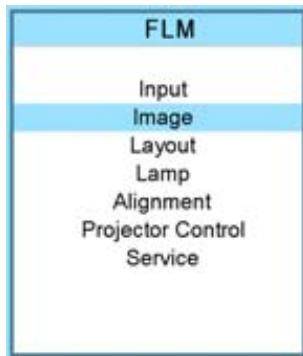

Image 9-51



Image 9-52

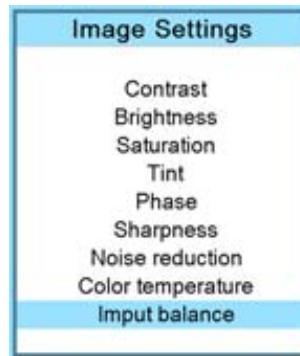

Image 9-53

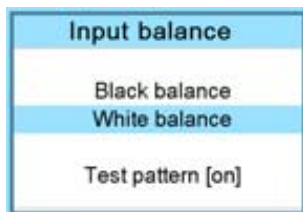

Image 9-54

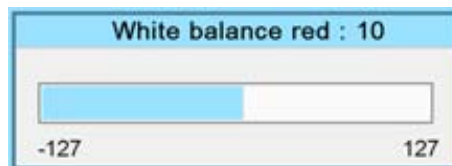

Image 9-55

9. Adjust the red white level (gain) on a minimal value
10. Toggle with **▲** or **▼** key to *White balance blue* and adjust the blue white level (gain) on a minimal value.
Note: *This minimal value is not necessary, provided that the 2 other colors are not influencing too much the color to be adjusted, in fact the aim is to minimize the effect of the two other colors since there is a risk of reaching too soon the transition (bright spots) due to the contribution of these two other colors signals.*
11. Toggle with **▲** or **▼** key to *White balance green* and adjust the Green white level (gain) until bright spots appear on the screen.
12. Toggle with **▲** or **▼** key to *White balance blue* adjust the Blue white level (gain) until bright spots appear on the screen.
13. Toggle with **▲** or **▼** key to *White balance red* adjust the Red white level (gain) until bright spots appear on the screen.

The projected image should now be noisy neutral gray.

9.4 Aspect ratio



Aspect ratio

Relation between the horizontal & vertical dimension in which the window will be displayed, e.g. 4 by 3 or 16 by 9. Can also be expressed as a decimal number, such as 1.77. The larger the ratio or decimal, the wider are less square the image.

What can be done?

The aspect ratio setting forces the projector to project an image using a defined aspect ratio

Aspect ratio	Description
4:3	Standard television format
16:9	Wide screen television format / anamorphic format
5:4	Workstation format
2.35	Film format
1.88	
1.78	Wide screen television format / anamorphic format
Custom	Any custom format can be set up

Type of input signal is indicated above each image row. The image row shows how the image will be projected in the different aspect ratio settings.

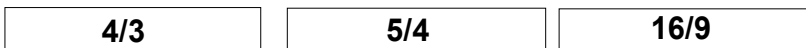

Video Signal Pal/Secam



Video Signal NTSC



Video Signal 16/9

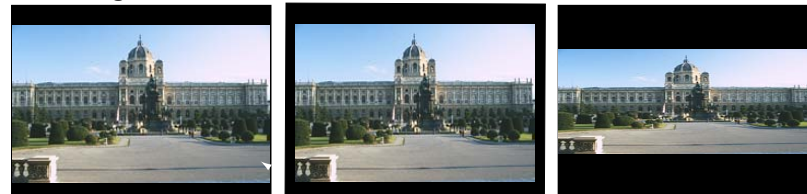

4/3 RGB Signal

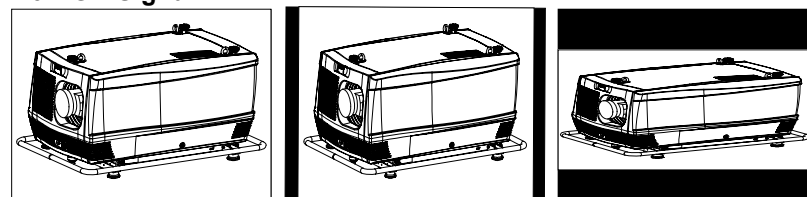

Image 9-56
Some examples for aspect ratio

How to select an Aspect ratio?

1. Press **MENU** to activate the menus.
2. Use the **▲** or **▼** key to select *Image* and press **ENTER**.
3. Use the **▲** or **▼** key to select *Aspect ratio* and press **ENTER**.
The aspect ratio menu will be displayed.
4. Use the **▲** or **▼** key to select the desired aspect ratio and press **ENTER**.

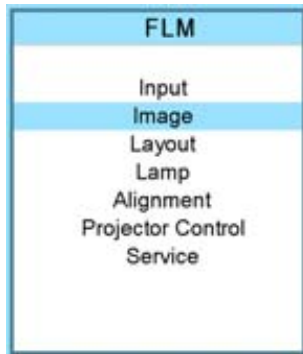

Image 9-57



Image 9-58

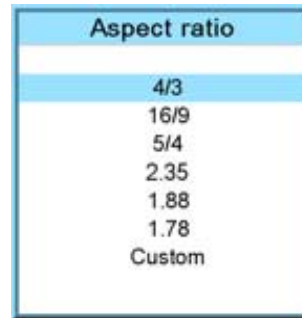

Image 9-59

How to set up a custom aspect ratio?

1. Select first *Custom* and press **ENTER** to activate.
The *Custom aspect ratio* dialog box opens.
2. Use the **▲** or **▼** key to adjust the vertical size of the image.
Use the **▶** or **◀** key to adjust the horizontal size of the image.
When the desired aspect ratio is obtained, press **EXIT**.

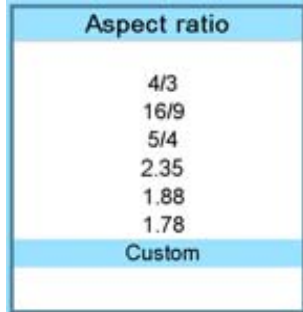

Image 9-60

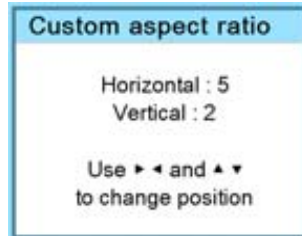

Image 9-61

9.5 Timings

9.5.1 Source timings

Adjustable items

- Horizontal start in pixels : number of pixels between the beginning of the input signal and the start of the video information in the signal.
- Width = Active horizontal pixels : determine the width of the window on the screen. This value is normally given in the source specifications. If not, adjust until full image is displayed (no missing pixels).
- Vertical start in lines : number of lines between the start of the input signal and start of the image on the screen.
- Height = Active vertical lines : number of horizontal lines determining the height of the projected image. this value is normally given in the specification of the source. If not, adjust until full image height is displayed (no missing lines).
- Total pixels: Total horizontal pixels in the source. If the value is wrong, sampling mistakes (small vertical bars in the projected image) will be seen in the image.
- Total lines: Total vertical lines in the source.

How to start up?

1. Press **MENU** to activate the menus.
2. Use the **▲** or **▼** key to select *Image* and press **ENTER**.
3. Use the **▲** or **▼** key to select *Timings* and press **ENTER**.

The timings menu will be displayed.

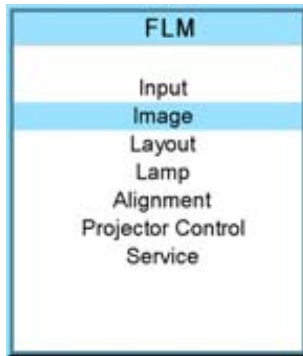

Image 9-62

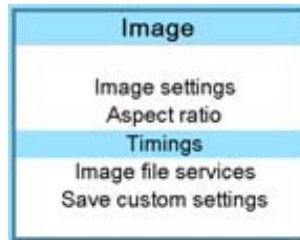

Image 9-63

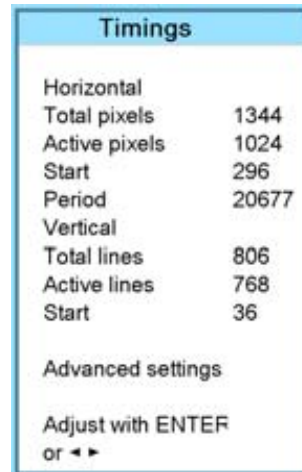

Image 9-64

4. To change a setting, use the **▲** or **▼** key to select and press **ENTER**.
The corresponding adjustment box is displayed. E.g. Horizontal total pixels.

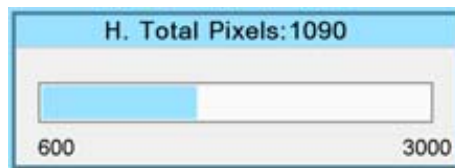

Image 9-65

5. Use the **▲** or **▼** key (or **◀** or **▶** key) to change the value.
6. Press **ENTER** to activate the new value.
7. If necessary to change other settings, repeat from step 4.

9.5.2 Advanced settings

About the advanced settings

- | | |
|-------------|---|
| Clamp delay | The time between the leading edge of the clamp pulse and the locked edge of the sync pulse. Can be any value between 0 and 255. |
| Clamp width | The width of the clamp pulse can be any value between 0 and 255. |

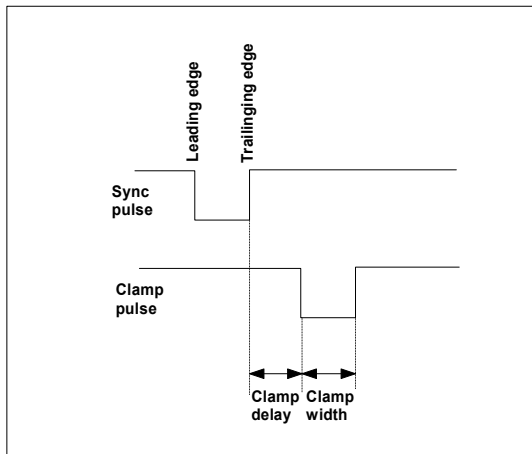

Image 9-66

Field polarity The field polarity function is used for interlaced images. Both rasters of the image could be shifted in a wrong way (double lines are visible in the image). This can be corrected by forcing the field polarity to [neg] or [pos].

How to change the clamp delay - clamp width?

1. Press **MENU** to activate the menus.
2. Use the **▲** or **▼** key to select *Image* and press **ENTER**.
3. Use the **▲** or **▼** key to select *Timings* and press **ENTER**.
4. Use the **▲** or **▼** key to select *Advanced settings* and press **ENTER**.
The Advanced settings menu is displayed.
5. Use the **▲** or **▼** key to select *Clamp delay* or *Clamp width* and press **ENTER**.
A progress bar appears.
6. Use the **▲** or **▼** key to change the setting.

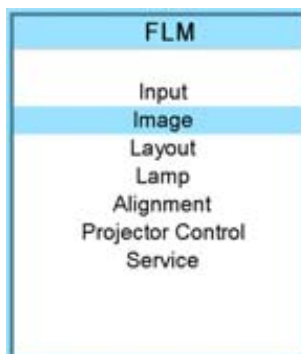

Image 9-67



Image 9-68

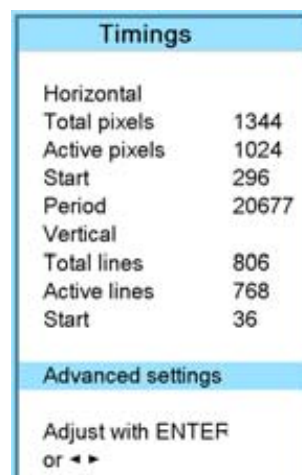

Image 9-69

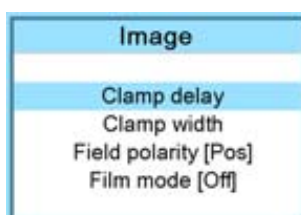

Image 9-70

How to change the field polarity?

1. Press **MENU** to activate the menus.
2. Use the **▲** or **▼** key to select *Image* and press **ENTER**.
3. Use the **▲** or **▼** key to select *Advanced settings* and press **ENTER**.

The Advanced settings menu is displayed.

4. Use the **▲** or **▼** key to select *Field polarity* and press **ENTER** to toggle between [neg] or [pos].

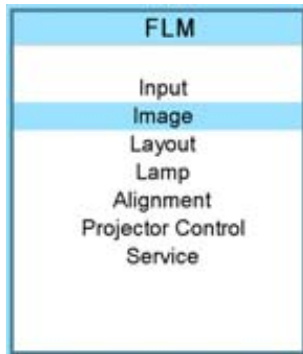

Image 9-71

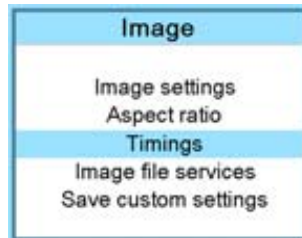

Image 9-72

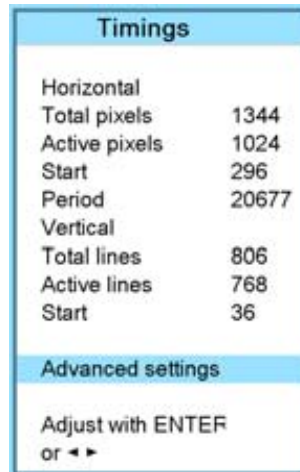

Image 9-73

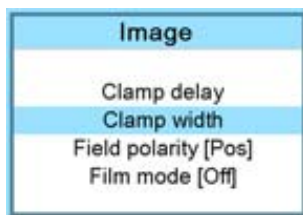

Image 9-74

9.5.3 Advanced settings, film mode detection

About film mode detection

This mode detects whether film or video is displayed.

When enabled, the hardware looks for tell-tale signs of 3:2 or 2:2 pull-down sequences. These are the result of converting cinema material recorded at 24 frames-per-second to the television frequencies of 60 or 50 interlaced fields per second respectively. When FILM conversion is detected, the original 24 frames-per-second are restored. This avoids deinterlacing artefacts, and results in a perfect artefact-free display. Note that in some cases (video clips, scrolling newstickers,...) FILM and VIDEO material are mixed on one screen. This may confuse the detector and cause it to go into FILM restoration mode. This will cause "jaggies" or motion artefacts. In such cases, disabling FILM mode processing is the best cure.



Film mode detection is only for interlaced sources.



3:2 pull-down

Method used to map the 24 fps of film onto the 30 fps (60 fields) or 25 fps (50 fields), so that one film frame occupies three video fields, the next two, etc. It means the two fields of every other video frame come from different film frames making operations such as rotoscoping impossible, and requiring care in editing. Some sophisticated equipment can unravel the 3:2 sequence to allow frame-by-frame treatment and subsequently re-compose 3:2. The 3:2 sequence repeats every five video frames and four film frames, the latter identified as A-D. Only film frame A is fully on a video frame and so exists at one time code only, making it the editable point of the video sequence.

**2:2 pull-down**

The process of transferring 24-frames/sec film format into video by repeating each frame (used for PAL DVD's) as two video fields. (AD)

**Artefacts**

Undesirable elements or defects in a video picture. These may occur naturally in the video process and must be eliminated in order to achieve a high-quality picture. Most common in analog are cross color and cross luminance. Most common in digital are macroblocks, which resemble pixelation of the video image.

How to set up

1. Press **MENU** to activate the menus.
2. Use the **▲** or **▼** key to select *Image* and press **ENTER**.
3. Use the **▲** or **▼** key to select *Advanced settings* and press **ENTER**.

The Advanced settings menu is displayed.

4. Use the **▲** or **▼** key to select *Film mode* and press **ENTER** to toggle between [auto] or [off].

Auto Detects for film and it starts to avoid deinterlacing artefacts, and it results in a perfect artefact-free display.

Off no detection for film mode.

When film with a banner is projected at the same time, and film mode is auto, the banner will shown possible artefacts as the software will detect a film.

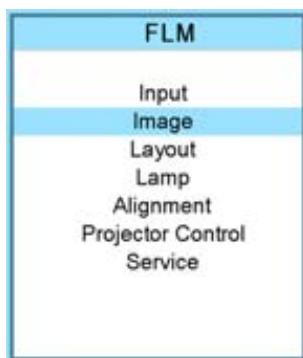

Image 9-75



Image 9-76

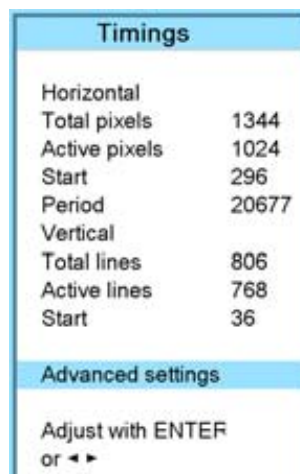

Image 9-77

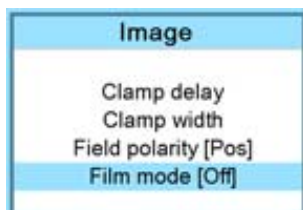

Image 9-78

9.6 Image files services

Overview

- Files and file manipulations
- Manual Load file
- Delete file
- Delete all custom files
- Rename a file
- Copy a file
- File options

9.6.1 Files and file manipulations

Connecting a new source.

Before using a new source, a correct file has to be installed. The projector's memory contains a list of files corresponding to the most used sources. When the new source corresponds with one of these files, the file can be loaded and saved for future use. When there is a little difference, the file can also be loaded and then edited until the source specs are reached.

VESA standards and video standards are pre-programmed.

Possible file Manipulations

The following file manipulations are possible :

- Load : installation of a file for a new source.
- Rename : renaming a file.
- Delete : deleting a file (only custom files)
- Delete all : delete all custom files
- Options : way of loading a file when a source is selected.

A loaded file can be edited via the Timings menu. Once a file is edited, it will be saved with the same name as the original file, followed by a sequence number between rounded brackets.

9.6.2 Manual Load file

How to load?

1. Press **MENU** to activate the menus.
2. Use the **▲** or **▼** key to select *Image* and press **ENTER**.
3. Use the **▲** or **▼** key to select *File services* and press **ENTER**.
The File service menu is displayed.
4. Use the **▲** or **▼** key to select *Manual load* and press **ENTER**.
The manual load window opens.

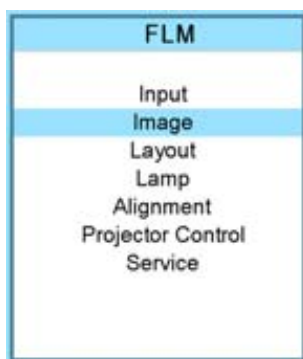

Image 9-79



Image 9-80

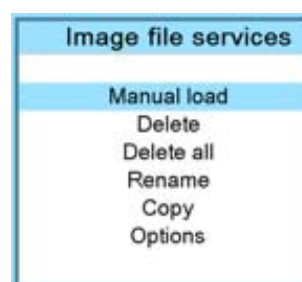

Image 9-81

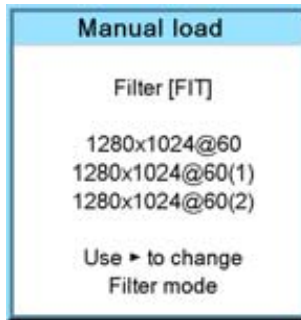

Image 9-82

Depending on the filter setup, the following is displayed:

- Fit: only fitting files for the selected source will be in the list
- All: all files in the system will be in the list.

5. Do you want to see only the fitting file in the manual load menu?
If yes, Select *Filter* and use ► till [FIT] is on the menu.
If no, Select *Filter* and use ► till [ALL] is on the menu.
6. Use the ▲ or ▼ key to select the appropriate file. While scrolling over the files, a preview is shown on the screen.
7. Press **ENTER** to select.
The selected file is loaded.

The image is not perfect?

If the displayed image is not correct after selecting the best fitting file, go to the *Timings* menu and change the file settings.

9.6.3 Delete file

How to delete?

1. Press **MENU** to activate the menus.
2. Use the ▲ or ▼ key to select *Image* and press **ENTER**.
3. Use the ▲ or ▼ key to select *File services* and press **ENTER**.
The File service menu is displayed.
4. Use the ▲ or ▼ key to select *Delete* and press **ENTER**.
The delete window opens.
5. Use the ▲ or ▼ key to select the file which must be deleted.
Note: Only custom files can be deleted.
6. Press **ENTER** to delete the selected file.

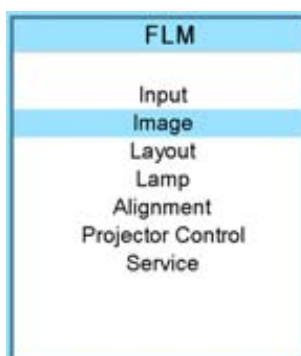

Image 9-83



Image 9-84

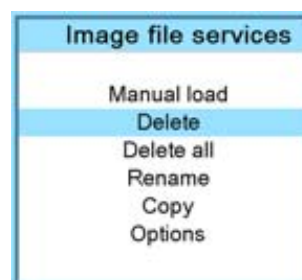

Image 9-85



Image 9-86



No recovery possible !

9.6.4 Delete all custom files

How to delete?

1. Press **MENU** to activate the menus.
2. Use the **▲** or **▼** key to select *Image* and press **ENTER**.
3. Use the **▲** or **▼** key to select *File services* and press **ENTER**.
The File service menu is displayed.
4. Use the **▲** or **▼** key to select *Delete all* and press **ENTER**.
A delete all confirmation window opens.
5. Use the **▲** or **▼** key to select *Yes* if you are sure to delete all custom files and press **ENTER** to activate the selection.

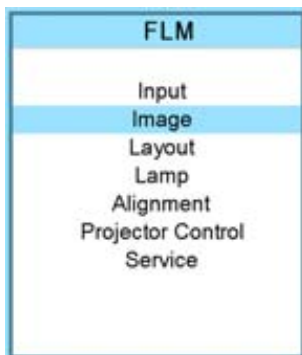

Image 9-87



Image 9-88

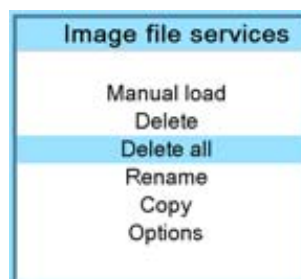

Image 9-89



Image 9-90

Or,
if you are not sure to delete all custom files, select *No* and press **ENTER** to activate the selection.

9.6.5 Rename a file

How to rename?

1. Press **MENU** to activate the menus.

2. Use the ▲ or ▼ key to select *Image* and press **ENTER**.
3. Use the ▲ or ▼ key to select *File services* and press **ENTER**.
The File service menu is displayed.
4. Use the ▲ or ▼ key to select *Rename* and press **ENTER**.
The rename window opens.
5. Use the ▲ or ▼ key to select the file which must be renamed.
Note: *Only custom files can be renamed.*
6. Press **ENTER** to select.
The rename window opens. The first character is selected.
7. Use the ▲ or ▼ key to change the selected character.
Use the ◀ or ▶ key to selected another character.
Note: *Digits can be entered with the digit keys on the remote control or on the local keypad. When a digit is entered in that way, the next character will be selected automatically.*
8. Press **ENTER** to finalize the rename action.

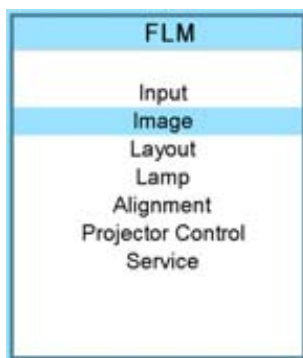

Image 9-91



Image 9-92

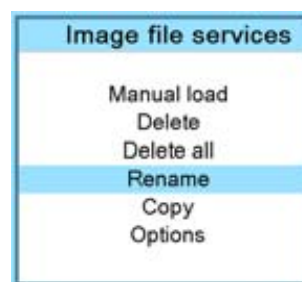

Image 9-93

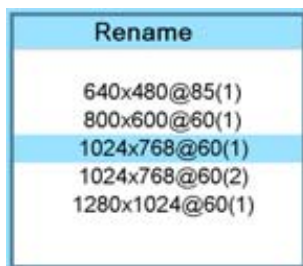

Image 9-94



Image 9-95

9.6.6 Copy a file

How to copy?

1. Press **MENU** to activate the menus.
2. Use the ▲ or ▼ key to select *Image* and press **ENTER**.
3. Use the ▲ or ▼ key to select *File services* and press **ENTER**.
The File service menu is displayed.
4. Use the ▲ or ▼ key to select *Copy* and press **ENTER**.
The copy window opens.
5. Use the ▲ or ▼ key to select the file which must be copied.
6. Press **ENTER** to select.
The copy window opens. The first character is selected.
7. Use the ▲ or ▼ key to change the selected character.
Use the ◀ or ▶ key to selected another character.
Note: *Digits can be entered with the digit keys on the remote control or on the local keypad. When a digit is entered in that way, the next character will be selected automatically.*
8. Press **ENTER** to finalize the copy action.

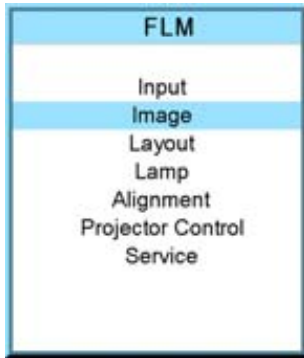

Image 9-96



Image 9-97



Image 9-98

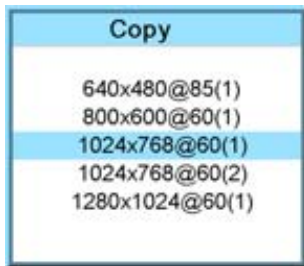

Image 9-99



Image 9-100

9.6.7 File options

How to set the options?

1. Press **MENU** to activate the menus.
2. Use the **▲** or **▼** key to select *Image* and press **ENTER**.
3. Use the **▲** or **▼** key to select *Image services* and press **ENTER**.
The Image service menu is displayed.
4. Use the **▲** or **▼** key to select *Options* and press **ENTER**.

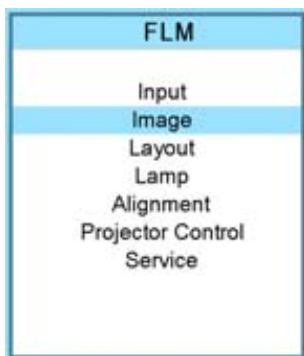

Image 9-101



Image 9-102

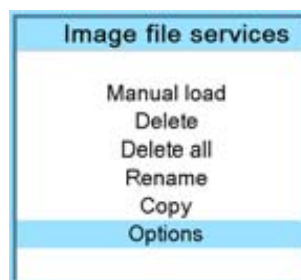

Image 9-103

The options window opens.

5. Use the **▲** or **▼** key to select *Load file* and press **ENTER** to toggle between [Automatic], [Manual] and [Custom only].

- [Automatic]: correct file will be loaded automatically.
- [Manual]: correct file has to be loaded manually.
- [Custom only]: correct file will be loaded automatically out of the available custom files.

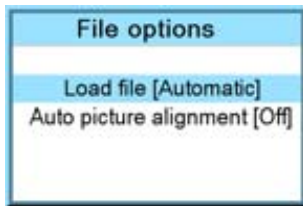

Image 9-104

- Use the ▲ or ▼ key to select *Auto picture alignment* and press **ENTER** to toggle between [Off], [Always] and [File load].

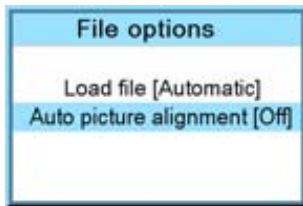

Image 9-105

- [Off]: no auto picture alignment activated.
- [Always]: always auto picture alignment activated. When sync disappears and comes back, an auto picture alignment is executed.
- [Load file]: auto picture alignment executed each time a new file is loaded.

9.7 Save custom settings

What is done?

The current custom settings can be saved to the internal backup device in the same way as it would be done when the projector was switched to standby.

How to save

- Press **MENU** to activate the menus.
- Use the ▲ or ▼ key to select *Image* and press **ENTER**.
- Use the ▲ or ▼ key to select *Save custom settings* and press **ENTER**.

The custom settings are written to the internal backup device. A message menu "Save data ..." is displayed during the save operation.

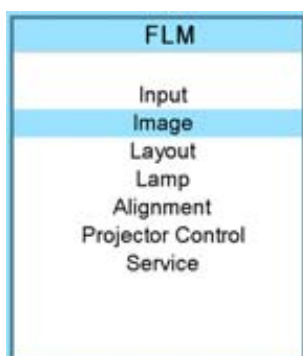

Image 9-106

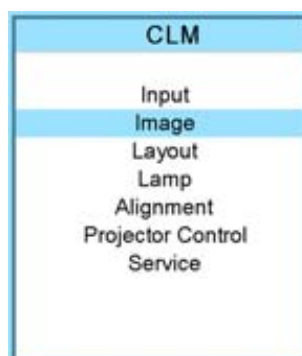

Image 9-107



Image 9-108

10. LAYOUT MENU

Overview

- Overview flow
- Main window
- PIP window
- Layout file services
- Zoom - Focus

10.1 Overview flow

Overview

Level 1	Level 2	Level 3	Level 4
Layout			
	Main window	Source Size Position	
	PIP window	PIP window [ON/OFF] Source Size Position	
	Layout file services	Load	Main full screen PIP top right Split top bottom
		Rename Delete Copy / Save as	
	Zoom/Focus	Same for each layout	yes no

10.2 Main window

Overview

- Source selection
- Size adjustment
- Position adjustment

When active layout is read only

When the active layout is a read only layout, the projector will ask to create a new layout.

Use the ▲ or ▼ key to select *Yes* or *No* and press **ENTER**.

If *Yes* is selected an *Enter layout name* window opens.

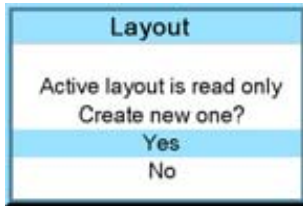

Image 10-1

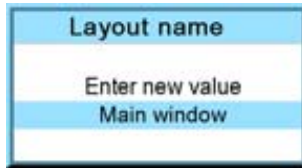

Image 10-2

The first character is highlighted. Use the ▲ or ▼ key to select the desired character and press ◀ or ▶ key to select the next character in the name.

Press **EXIT** to return. The new file is generated.

10.2.1 Source selection

What can be done ?

The source of the main window can be selected via the *Main window* menu.

How to select a source

1. Press **MENU** to activate the menus.
2. Use the ▲ or ▼ key to select *Layout* and press **ENTER**.
3. Use the ▲ or ▼ key to select *Main Window* and press **ENTER**.

The main window opens.

4. Use the ▲ or ▼ key to select *Source* and press **ENTER**.

The source selection window opens.

5. Use the ▲ or ▼ key to select the desired source and press **ENTER** to activate.

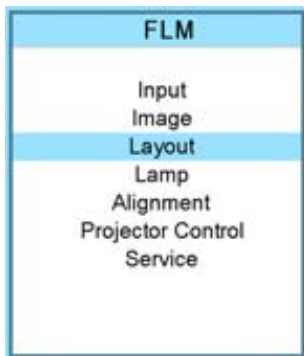

Image 10-3

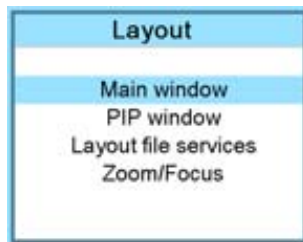

Image 10-4

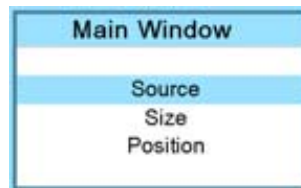

Image 10-5

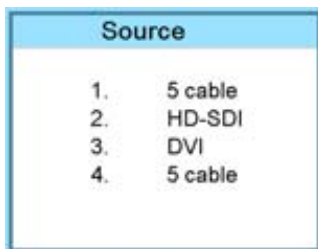

Image 10-6

10.2.2 Size adjustment

What can be done?

The size of the main window can be adjusted until the desired window dimensions are reached.

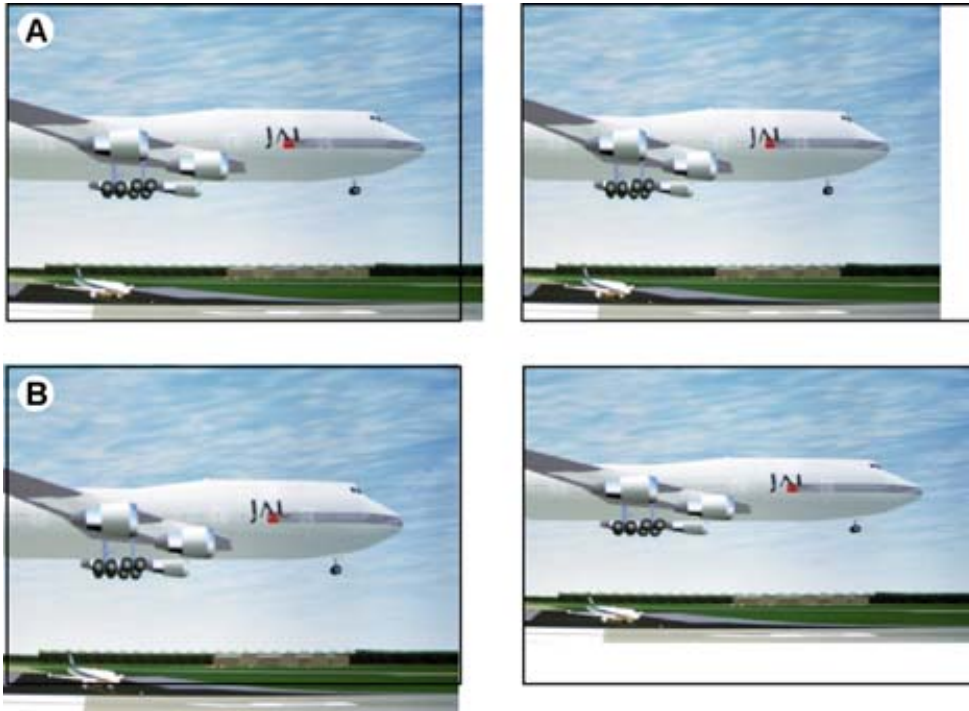

Image 10-7
Size adjustment main window

- A width adjustment
- B height adjustment

The size can be changed with respect to the original aspect ratio.

How to adjust with respect to the original aspect ratio?

1. Press **MENU** to activate the menus.
2. Use the **▲** or **▼** key to select *Layout* and press **ENTER**.
3. Use the **▲** or **▼** key to select *Main Window* and press **ENTER**.

The main window opens.

4. Use the **▲** or **▼** key to select *Size* and press **ENTER**.

The size adjustment window opens.

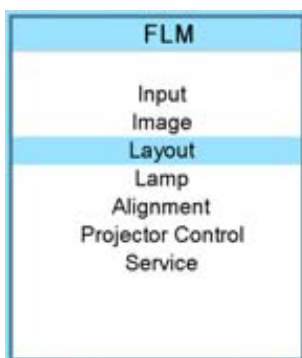

Image 10-8

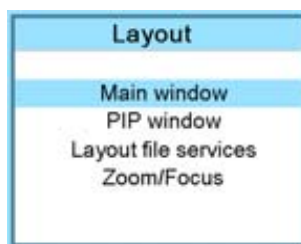

Image 10-9

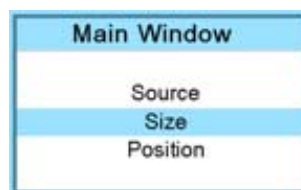

Image 10-10

5. Toggle with **ENTER** till Lock is set to [x].

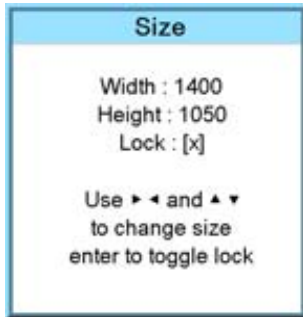

Image 10-11

[] = no lock between height and width.

[x] = width and height are locked.

6. Use ► ◀ or ▲ ▼ to adjust the size with respect to the original aspect ratio. When the desired size is reached, press **EXIT**.

A Save window opens.

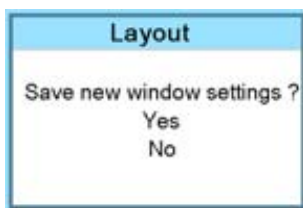

Image 10-12

How to adjust height and width separately?

1. Press **MENU** to activate the menus.
2. Use the ▲ or ▼ key to select *Layout* and press **ENTER**.
3. Use the ▲ or ▼ key to select *Main Window* and press **ENTER**.
The main window opens.
4. Use the ▲ or ▼ key to select *Size* and press **ENTER**.
The size adjustment window opens.

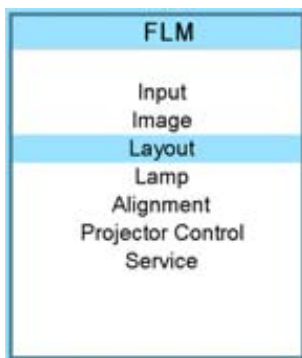

Image 10-13

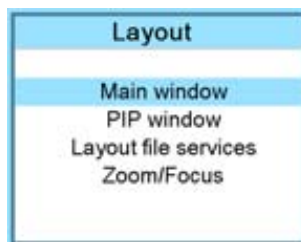

Image 10-14

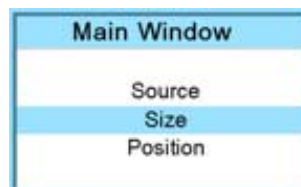

Image 10-15

5. Toggle with **ENTER** till Lock is set to [].

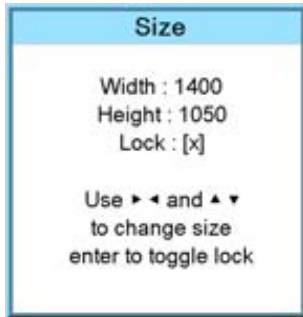

Image 10-16

[] = no lock between height and width.

[x] = width and height are locked.

- Use the ▲ or ▼ key to adjust the height.
Use the ◀ or ▶ key to adjust the width.
When the desired size is reached, press **EXIT**.

A Save window opens.

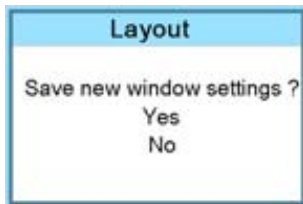

Image 10-17

- Select with the ▲ or ▼ key Yes and press **ENTER**.
Select with the ▲ or ▼ key No, when no save is desired and press **ENTER**.

10.2.3 Position adjustment

What can be done?

The main window can be repositioned on the screen. The upper left corner is the reference.

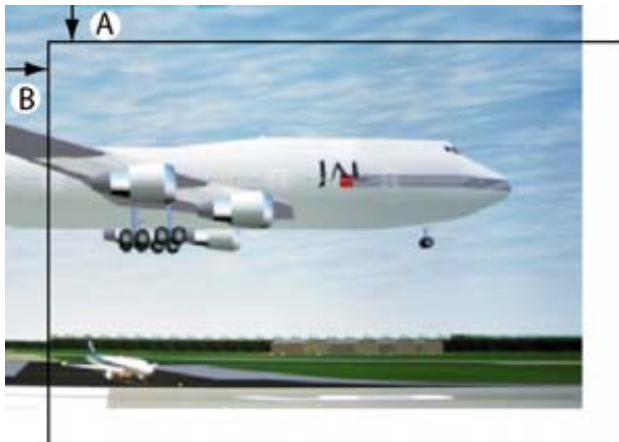
Image 10-18
Positioning the window

How to position?

- Press **MENU** to activate the menus.
- Use the ▲ or ▼ key to select *Layout* and press **ENTER**.
- Use the ▲ or ▼ key to select *Main Window* and press **ENTER**.
The main window opens.
- Use the ▲ or ▼ key to select *Position* and press **ENTER**.
The position adjustment window opens.
- Use the ▲ or ▼ key to adjust top start point.

10. Layout menu

Use the ◀ or ▶ key to adjust left start point.
When the desired size is reached, press **EXIT**.

A Save window opens.

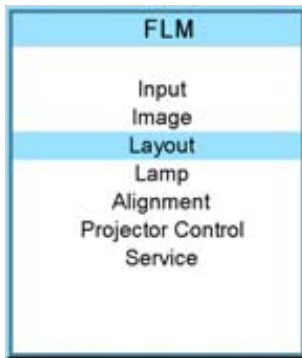

Image 10-19

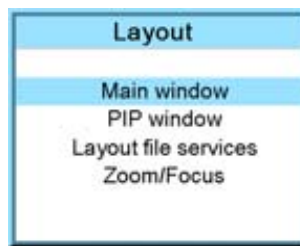

Image 10-20

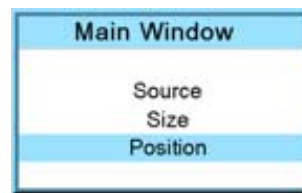

Image 10-21

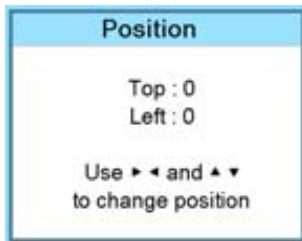

Image 10-22

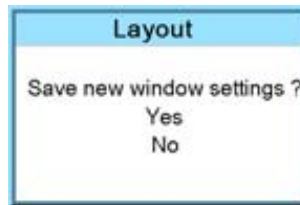

Image 10-23

6. Select with the ▲ or ▼ key **Save** and press **ENTER**.
Select with the ▲ or ▼ key **Delete**, when no save is desired and press **ENTER**.

10.3 PIP window

Overview

- Introduction to PIP
- Picture in Picture activation
- Picture in Picture source selection
- Picture in Picture size of the window
- Picture in Picture, position window

10.3.1 Introduction to PIP



PiP

PiP stands for "Picture in Picture" and allows to display multiple windows containing each of them an image. The windows may be of the video or data type.

What are the different possibilities within the PiP mode ?

The input section of the projector allows a combinations of different input signals which may be projected in the 2 windows of the PiP screen. The PiP window can be placed anywhere, with any dimensions, on the screen by changing its position and its size.

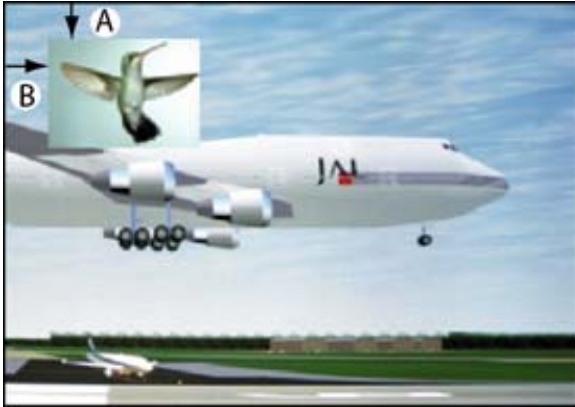

Image 10-24
Position of PIP

- A Top position
B Left position

10.3.2 Picture in Picture activation

How to activate PIP?

1. Press **MENU** to activate the menus.
2. Use the **▲** or **▼** key to select *Layout* and press **ENTER**.
3. Use the **▲** or **▼** key to select *PIP Window* and press **ENTER**.
The PIP window opens.
4. Use the **▲** or **▼** key to select *On* or *Off* and press **ENTER** to toggle between [On] and [Off].

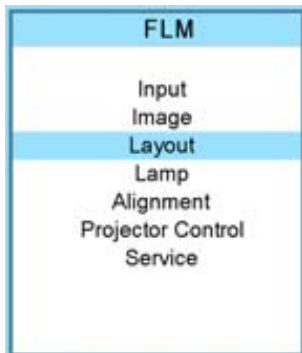

Image 10-25

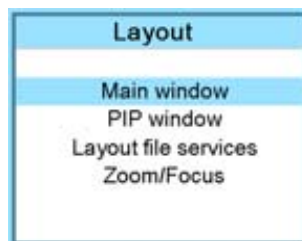

Image 10-26

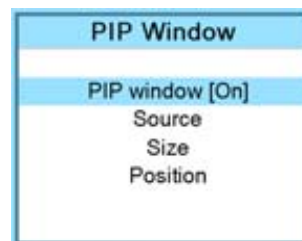

Image 10-27

5. Press **EXIT** to quit the menu.



When PIP is activated (ON state), the PIP window becomes the active window. Switching to the main window is still possible with the window button on the RCU.

10.3.3 Picture in Picture source selection

What can be done ?

The input source for the picture in picture window can be selected.

How to select a source

1. Press **MENU** to activate the menus.
2. Use the **▲** or **▼** key to select *Window* and press **ENTER**.
3. Use the **▲** or **▼** key to select *PIP Window* and press **ENTER**.
The PIP window dialog opens.
4. Use the **▲** or **▼** key to select *Source* and press **ENTER**.

10. Layout menu

The source selection window opens.

5. Use the ▲ or ▼ key to select the desired source and press **ENTER** to activate this source.

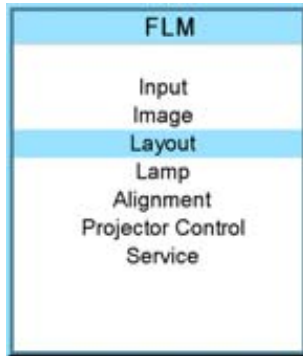

Image 10-28

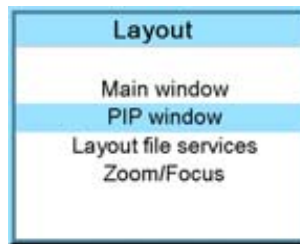

Image 10-29

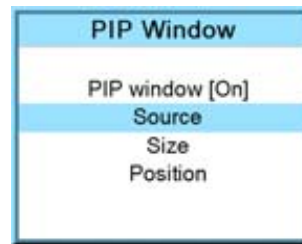

Image 10-30

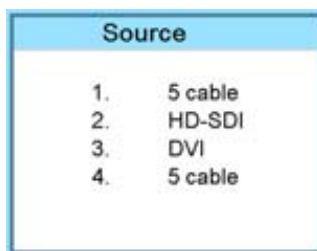

Image 10-31

10.3.4 Picture in Picture size of the window

What can be done?

The width and height of the picture in picture window can be changed till the desired dimensions are obtained.

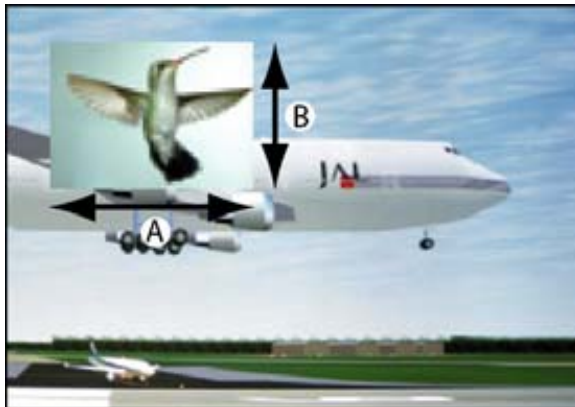

Image 10-32
Size PIP window

- A Width PIP window
- B Height PIP window

The size of the picture in picture window can be changed with respect to the original aspect ratio of the PIP image.

Remark: when e.g. the PIP window is a 4 by 3 window and the projected image has a 16 by 9 format, then it is possible that image jumps inside the PIP window during a re-scaling. Due to the fact that the re-scale is done on the vertical dimensions of the PIP window and the image inside it will be re-scaled so that the aspect ratio is still correct.



Image 10-33
Size PIP window remark

How to change the size with respect to the aspect ratio?

1. Press **MENU** to activate the menus.
2. Use the **▲** or **▼** key to select *Window* and press **ENTER**.
3. Use the **▲** or **▼** key to select *PIP Window* and press **ENTER**.

The main window opens.

4. Use the **▲** or **▼** key to select *Size* and press **ENTER**.

The size adjustment window opens.

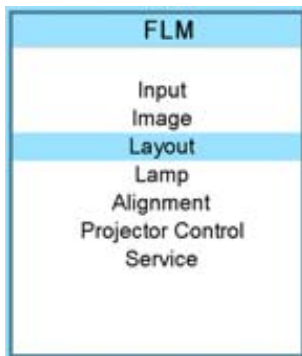

Image 10-34

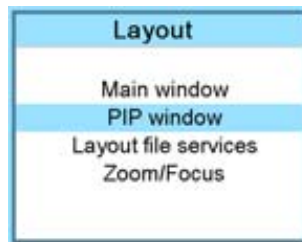

Image 10-35

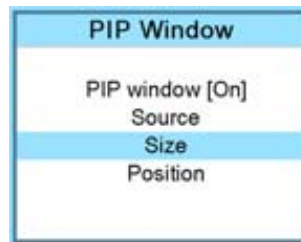

Image 10-36

5. Toggle with **ENTER** till Lock is set to [x].

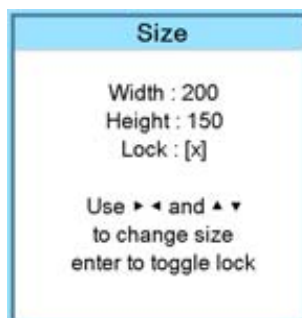

Image 10-37

[] = no lock between height and width.

[x] = width and height are locked.

6. Use the **▲ ▼** or **◀ ▶** key to adjust the size with respect to the aspect ratio. When the desired size is reached, press **EXIT**.

10. Layout menu

A Save window opens.

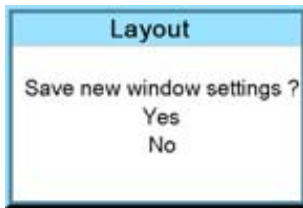

Image 10-38

7. Select with the ▲ or ▼ key Yes and press **ENTER**.
Select with the ▲ or ▼ key No, when no save is desired and press **ENTER**.

How to change the height and width separately?

1. Press **MENU** to activate the menus.
2. Use the ▲ or ▼ key to select *Window* and press **ENTER**.
3. Use the ▲ or ▼ key to select *PIP Window* and press **ENTER**.

The main window opens.

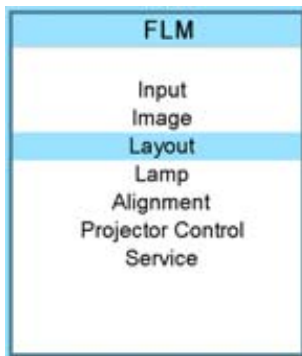

Image 10-39

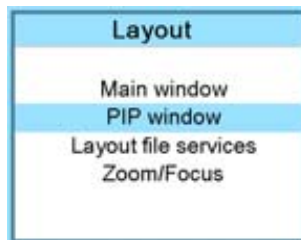

Image 10-40

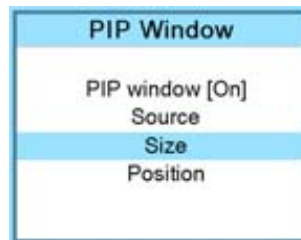

Image 10-41

4. Use the ▲ or ▼ key to select *Size* and press **ENTER**.
The size adjustment window opens.
5. Toggle with **ENTER** till Lock is set to [].

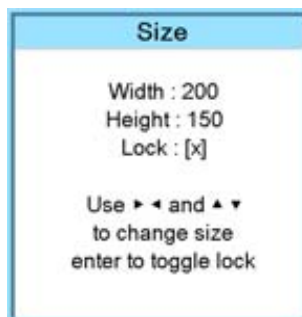

Image 10-42

[] = no lock between height and width.

[x] = width and height are locked.

6. Use the ▲ or ▼ key to adjust the height.
Use the ◀ or ▶ key to adjust the width.
When the desired size is reached, press **EXIT**.

A Save window opens.

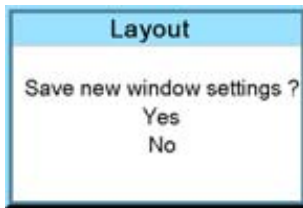

Image 10-43

- Select with the ▲ or ▼ key Yes and press **ENTER**.
Select with the ▲ or ▼ key No, when no save is desired and press **ENTER**.

10.3.5 Picture in Picture, position window

What can be done?

The picture in picture window can be position on any place on the display just by changing its start coordinates. The reference is the upper left corner of the window.

How to position?

- Press **MENU** to activate the menus.
- Use the ▲ or ▼ key to select *Window* and press **ENTER**.
- Use the ▲ or ▼ key to select *PIP Window* and press **ENTER**.
The PIP window opens.
- Use the ▲ or ▼ key to select *Position* and press **ENTER**.
The size adjustment window opens.
- Use the ▲ or ▼ key to adjust Top
Use the ◀ or ▶ key to adjust Left
When the desired position is reached, press **EXIT**.

A Save window opens.

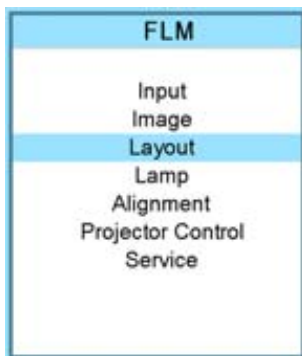

Image 10-44

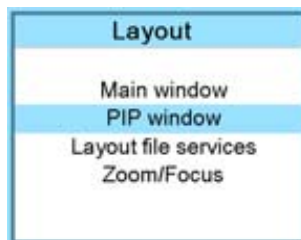

Image 10-45

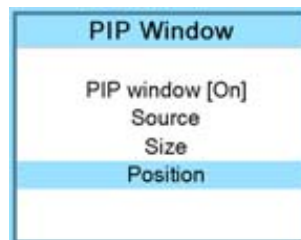

Image 10-46



Image 10-47

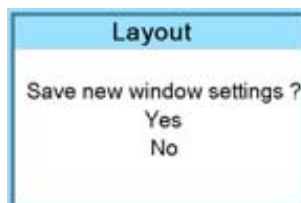

Image 10-48

- Select with the ▲ or ▼ key Yes and press **ENTER**.
Select with the ▲ or ▼ key No, when no save is desired and press **ENTER**.

10.4 Layout file services

Overview

- Load layout
- Rename a layout
- Delete a layout
- Copy / Save as a layout

10.4.1 Load layout



When loading a layout which required two sources, the *PIP window On/Off* setting will be switched to **ON**.

How to load?

1. Press **MENU** to activate the menus.
2. Use the **▲** or **▼** key to select *Window* and press **ENTER**.
3. Use the **▲** or **▼** key to select *Layout* and press **ENTER**.
The layout services window opens.
4. Use the **▲** or **▼** key to select *Load* and press **ENTER**.
The load layout window opens.

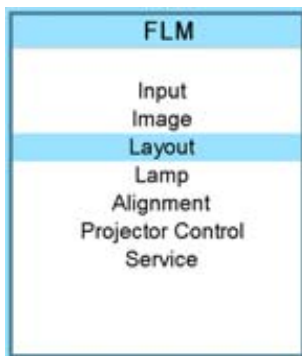

Image 10-49

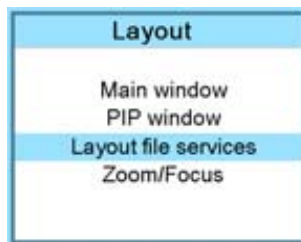

Image 10-50

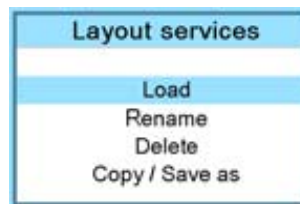

Image 10-51

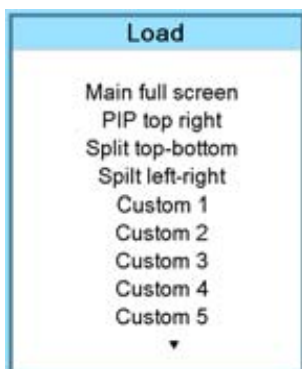

Image 10-52

5. Use the **▲** or **▼** key to select the desired layout and press **ENTER** to select.

The first 4 layouts are default layouts, all others are customer created layouts. The menu shows only the first 10 layouts, but use the **▼** to scroll through the rest of the layouts until the desired layout is found.



Rigging key + sequence number opens directly the desired layout.

10.4.2 Rename a layout



Only custom created layouts can be renamed.

How to rename?

1. Press **MENU** to activate the menus.
2. Use the **▲** or **▼** key to select *Window* and press **ENTER**.
3. Use the **▲** or **▼** key to select *Layout* and press **ENTER**.
The layout services window opens.
4. Use the **▲** or **▼** key to select *Rename* and press **ENTER**.
The Rename layout location window opens.
5. Use the **▲** or **▼** key to select the layout to rename and press **ENTER**.
The edit layout name window opens. The first character is selected.
6. Use the **▲** or **▼** key to change the selected character.
Use the **◀** or **▶** key to selected another character.
Note: *Digits can be entered with the digit keys on the remote control or on the local keypad. When a digit is entered in that way, the next character is selected automatically.*
7. Press **ENTER** to save the new name.

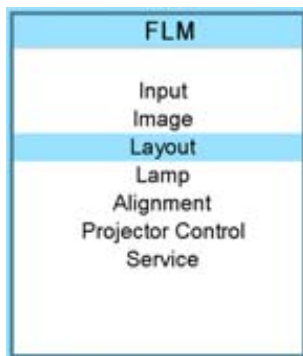

Image 10-53

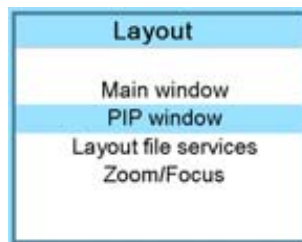

Image 10-54

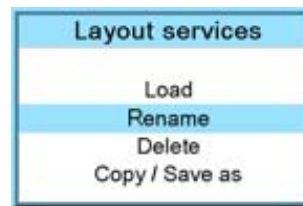

Image 10-55

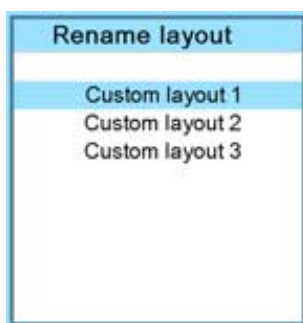

Image 10-56

10.4.3 Delete a layout

What is possible?

Custom created layouts can be removed from the projector memory.

How to delete?

1. Press **MENU** to activate the menus.
2. Use the **▲** or **▼** key to select *Window* and press **ENTER**.
3. Use the **▲** or **▼** key to select *Layout services* and press **ENTER**.

The layout services window opens.

- Use the ▲ or ▼ key to select *Delete* and press **ENTER**.

The *Delete* window opens.

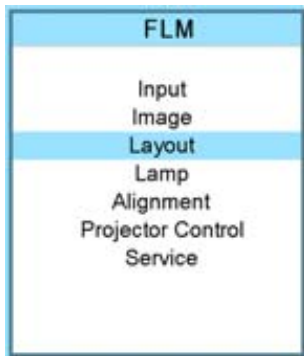

Image 10-57

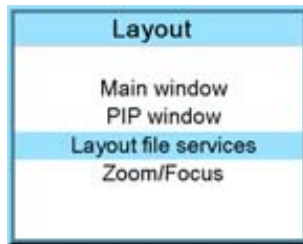

Image 10-58

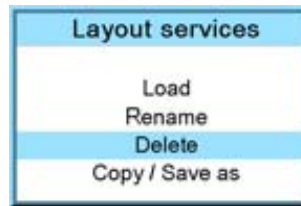

Image 10-59

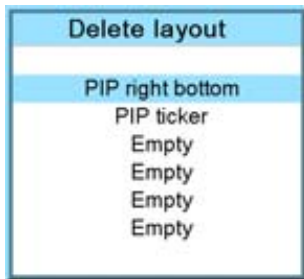

Image 10-60

The first 3 layouts are default layouts and cannot be delete.

- Use the ▲ or ▼ key to select the layout that must be deleted.
- Press **ENTER** to finalize the delete operation.

10.4.4 Copy / Save as a layout

What is possible,

An existing layout, system layout or custom created layout, can be copied into a new file.

How to copy / save as?

- Press **MENU** to activate the menus.
- Use the ▲ or ▼ key to select *Window* and press **ENTER**.
- Use the ▲ or ▼ key to select *Layout* and press **ENTER**.

The layout services window opens.

- Use the ▲ or ▼ key to select *Copy/Save as* and press **ENTER**.

The Save layout location window opens.

- Use the ▲ or ▼ key to select the layout to copy/save as and press **ENTER**.

The edit layout name window opens. The first character is selected.

- Use the ▲ or ▼ key to change the selected character.
Use the ◀ or ▶ key to selected another character.

Note: *Digits can be entered with the digit keys on the remote control or on the local keypad. When a digit is entered in that way, the next character is selected automatically.*

- Press **ENTER** to copy to the new name.
The new layout will be added to the list of layouts.

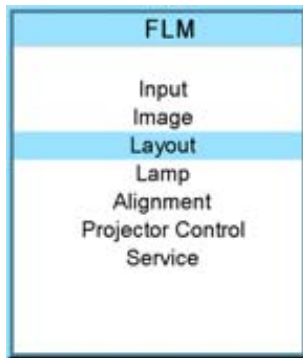

Image 10-61

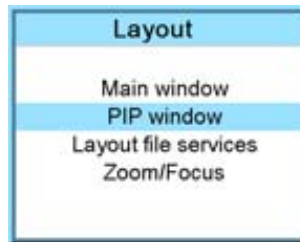

Image 10-62

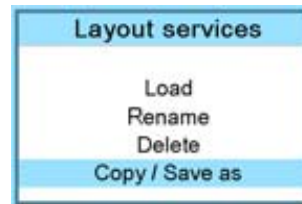

Image 10-63



Image 10-64

10.5 Zoom - Focus

What can be done ?

When changing from one layout to another, the zoom/focus settings can be different for each layout or they can be kept the same for all layouts.

How to set the zoom - focus setting

1. Press **MENU** to activate the menus.
2. Use the **▲** or **▼** key to select *Window* and press **ENTER**.
3. Use the **▲** or **▼** key to select *Layout* and press **ENTER**
The layout window opens.
4. Use the **▲** or **▼** key to select *Zoom/Focus as* and press **ENTER**.
The Zoom/Focus window opens.
5. Press **ENTER** to toggle between *[No]* and *[Yes]*.

[No] = each layout will use its own zoom/focus settings.

[Yes] = each layout will use the same zoom/focus settings. That means that the zoom/focus settings of the previous selected layout will be applied to the next selected layouts.

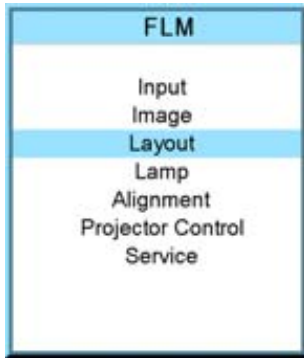

Image 10-65

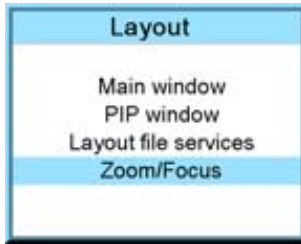

Image 10-66

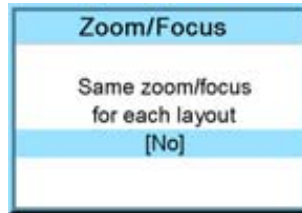

Image 10-67

11. LAMP MENU

Overview

- Overview flow
- Lamp power mode
- Lamp power
- Constant Light Output mode (CLO mode)
- CLO target
- Lamp Identification
- Z-axis adjustment

11.1 Overview flow

Overview

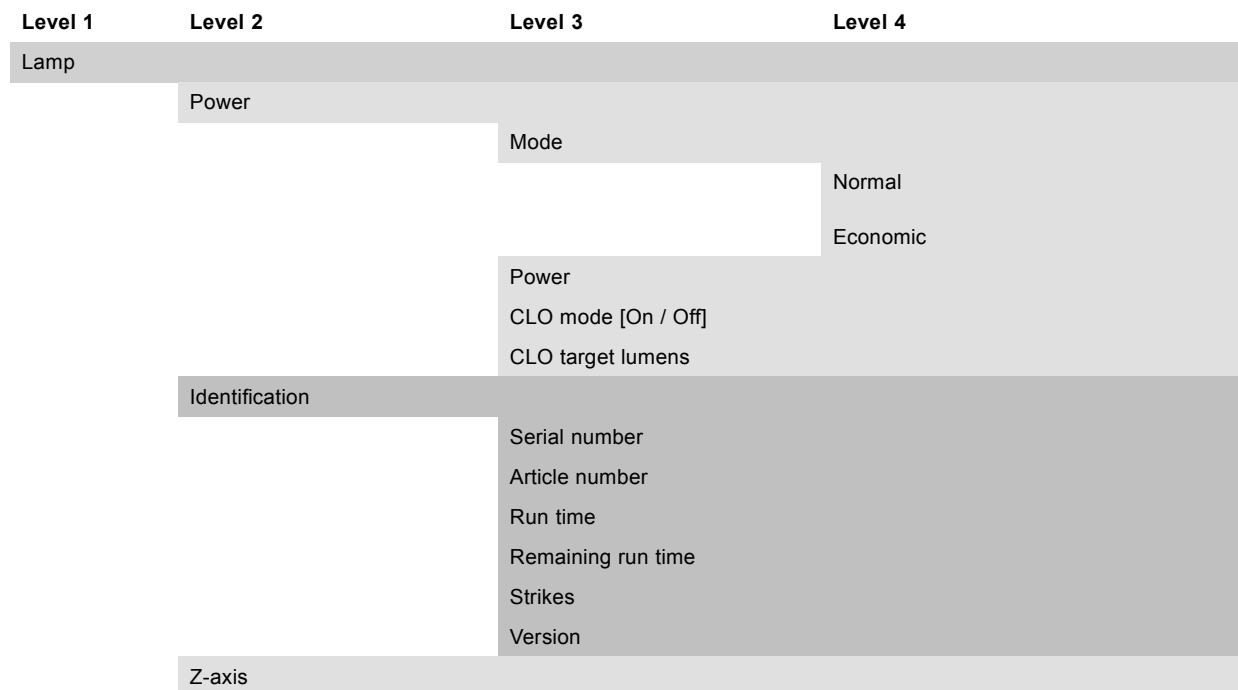

11.2 Lamp power mode

What can be done?

The lamp power mode can be switched between **Normal** and **Economic**. When playing in Economic mode, the lamp life time will increase.

Normal : maximum allowed powers is fed to the lamp. Maximum light output is reached in this way.

Economic : a reduced wattage is fed to the lamp. Reduced light output but a longer life time for the lamp.

How to switch?

1. Press **MENU** to activate the menus.
2. Use the **▲** or **▼** key to select *Lamp* and press **ENTER**.
3. Use the **▲** or **▼** key to select *Power* and press **ENTER**.
4. Use the **▲** or **▼** key to select *Mode*.
5. Press **ENTER** to toggle between [*Normal*] and [*Economic*].

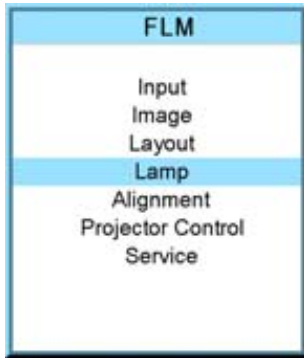

Image 11-1



Image 11-2

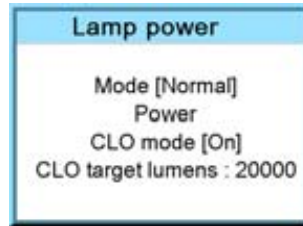

Image 11-3

Remarks

1. When mode is set to [Normal], then CLO mode can be switched *on* and *off*.
2. When switching the power mode to [Economic] while the CLO mode is On, then the CLO mode is switched to Off.
3. When the power mode is [Economic] and the CLO mode is switched to the [On] mode, then the power mode will be switched to the [Normal] mode.

11.3 Lamp power

What can be done?

Within a certain power mode, the light output of the lamp can be reduced.

How to reduce the lamp power?

1. Press **MENU** to activate the menus.
2. Use the ▲ or ▼ key to select *Lamp* and press **ENTER**.
3. Use the ▲ or ▼ key to select *Power* and press **ENTER**.
4. Use the ▲ or ▼ key to select *Power* and press **ENTER**.
5. Use the ▲ or ▼ key to change the lamp power.

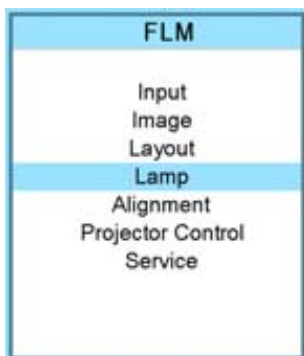

Image 11-4



Image 11-5



Image 11-6

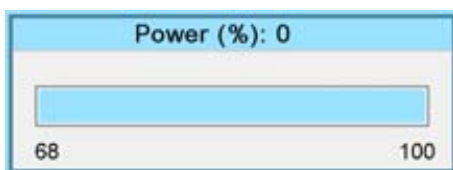

Image 11-7

11.4 Constant Light Output mode (CLO mode)

What can be done?

Constant Light Output allows to force a constant light output (set in the *CLO Target lumens* item) of the projector over a certain period. This will eliminate uncontrolled light output drop caused by natural aging of the lamp. The light output is checked every 5 minutes, if the target is not met, the lamp power is adjusted.

Setting CLO off means that the lamp will operate at constant power (no power adaptation to meet constant light output).

In the illustration below, a normal light output curve is shown over the first 1000 hours, image 11-8. By using CLO and setting the target to 60% of the maximum light output, one will be able to operate during approximately 500 hours with a constant light output, image 11-9.

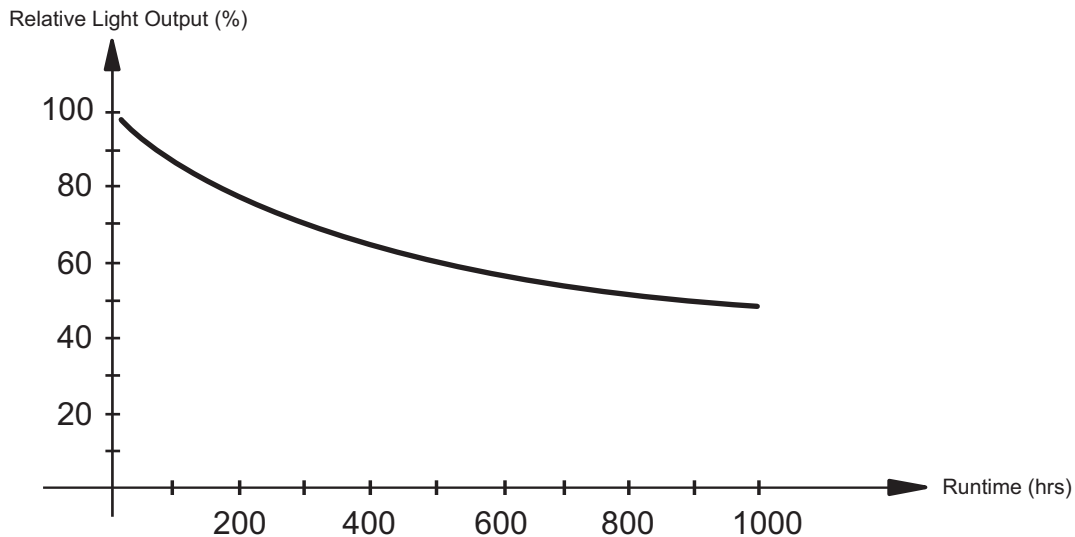

Image 11-8

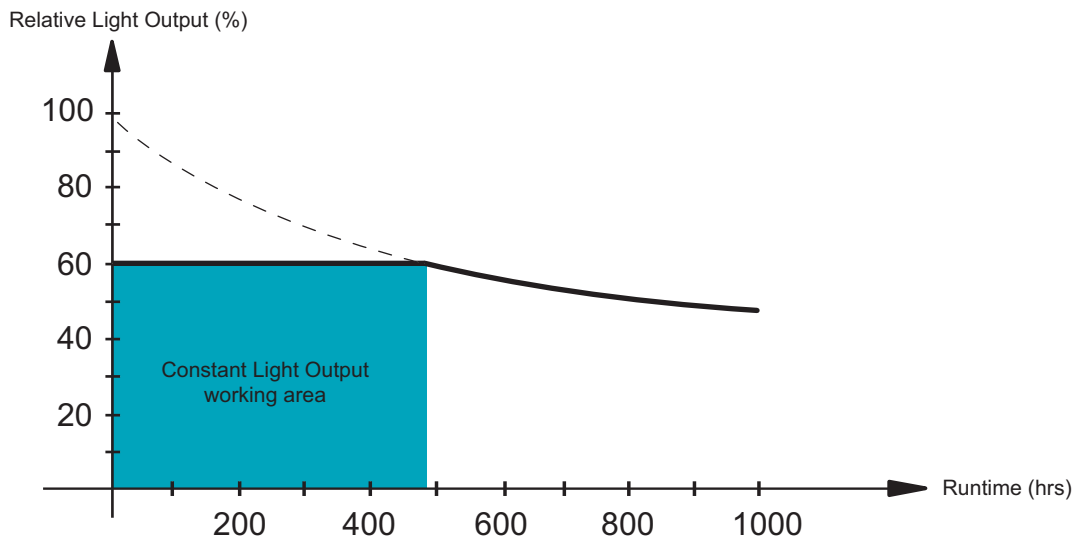

Image 11-9

How to set the CLO On or Off

1. Press **MENU** to activate the menus.
2. Use the **▲** or **▼** key to select *Lamp* and press **ENTER**.
3. Use the **▲** or **▼** key to select *Power* and press **ENTER**.
4. Use the **▲** or **▼** key to select *CLO mode* and press **ENTER** to toggle between *[On]* and *[Off]*

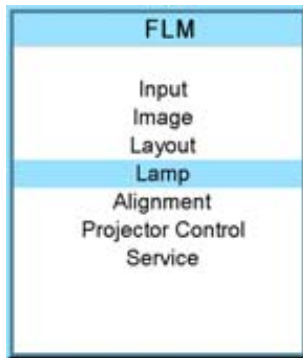

Image 11-10

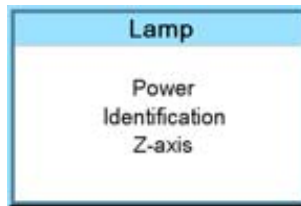

Image 11-11

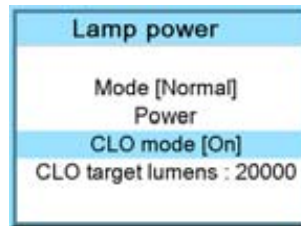

Image 11-12

11.5 CLO target

What must be done?

The light output target for the CLO is set in this menu item. This value will be forced on the projector provided the CLO mode has been set *On*.

How to enter the value

1. Press **MENU** to activate the menus.
2. Use the **▲** or **▼** key to select *Lamp* and press **ENTER**.
3. Use the **▲** or **▼** key to select *Power* and press **ENTER**.
4. Use the **▲** or **▼** key to select *CLO target lumens* and press **ENTER** to activate the first digit.
5. Use **◀** or **▶**, the numeric keys on the remote, or the keypad to change the target value.

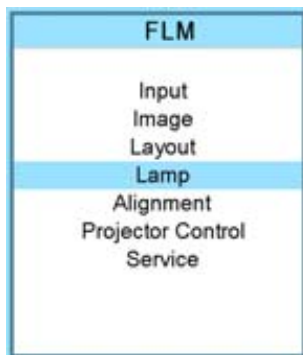

Image 11-13



Image 11-14

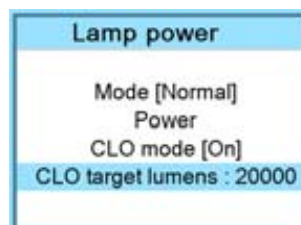

Image 11-15

11.6 Lamp Identification

About

The lamp identification menu gives an overview of the most important parameters of the used lamp.

These parameters are:

- Serial number lamp
- Article number of the used lamp
- Run time since first start up of the lamp
- Remaining run time for a safe operation of the lamp
- Number of strikes since the first start up of the lamp



These parameters are useful when calling for a service intervention.

How to display?

1. Press **MENU** to activate the menus.
2. Use the **▲** or **▼** key to select *Lamp* and press **ENTER**.
3. Use the **▲** or **▼** key to select *Identification* and press **ENTER**.

The identification overview is displayed.

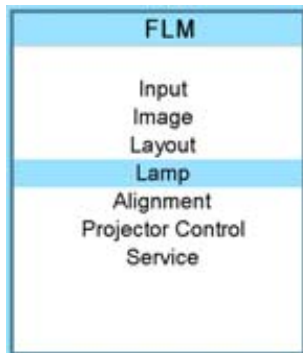

Image 11-16

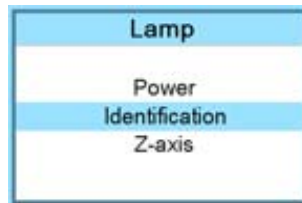

Image 11-17

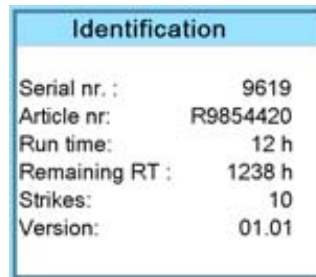

Image 11-18

11.7 Z-axis adjustment

What can be done?

This menu item gives the current light output of the projector. This light output indication can be used to readjust the lamp position in the lamp casing (also called Z-axis adjustment of the lamp). With higher run times, the light output of the lamp will decrease, which results in a lower light output on the screen. This light output decrease can be compensated by readjusting the position of the lamp. For the realignment procedure, see "Realignment of the lamp in its reflector", page 191.

How to display the light output

1. Press **MENU** to activate the menus.
2. Use the **▲** or **▼** key to select *Lamp* and press **ENTER**.
3. Use the **▲** or **▼** key to select *Z-axis* and press **ENTER**.

The Z-axis dialog box is display and indicates the current light output..

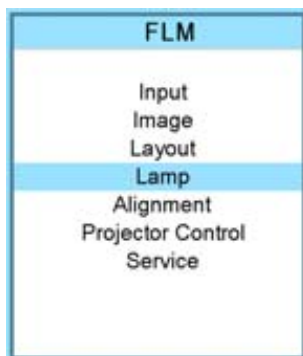

Image 11-19



Image 11-20

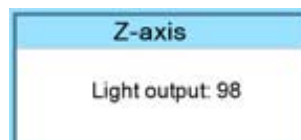

Image 11-21

12. ALIGNMENT MENU

About this chapter

This chapter describes the alignment of the projector once the physical installation is finished. Via the software, the image will be perfectly aligned on the screen.

Overview

- Overview flow
- Orientation
- Lens adjustment
- Side keystone
- Warp geometry settings
- Contrast enhancement
- Blanking
- Gamma
- Internal pattern
- Color space
- ScenergiX

12.1 Overview flow

Overview

Level 1	Level 2	Level 3
Alignment	Orientation	Front Table Front Ceiling Rear Table Rear Ceiling
	Lens	Zoom/Focus Shift Mid position
	Side keystone	
	Warp	Horizontal keystone Vertical keystone Rotation Pincushion / Barrel 4 corners Load file
	Blanking	Top Bottom Left Right Reset
	Contrast enhancement	

Level 1	Level 2	Level 3
	Gamma	
	Internal patterns	Checker board Color bars Convergence Focus Full screen black Full screen blue Full screen green Full screen red Full screen white Hatch Outline
	Color space	Projector EBU SMPTE Custom
	ScenergiX	Status White level Black level Show pattern Reset

12.2 Orientation

What can be done?

The way of physical installation of the projector can be defined to the projector.

The following installation are possible:

- front/table
- front/ceiling
- rear/table
- rear/ceiling

Set up the correct orientation

1. Press **MENU** to activate the menus.
2. Use the **▲** or **▼** key to select *Alignment* and press **ENTER**.
3. Use the **▲** or **▼** key to select *Orientation* and press **ENTER**.
4. Use the **▲** or **▼** key to select the correct orientation and press **ENTER**.

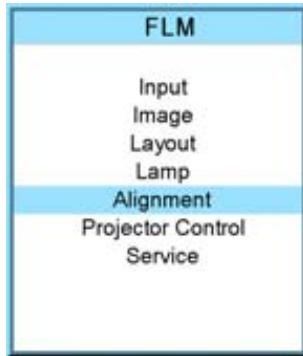

Image 12-1



Image 12-2

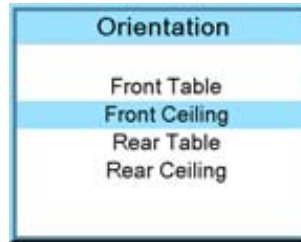

Image 12-3



For more information about the physical installation, see chapter “General”, “Projector configurations”.

12.3 Lens adjustment



Quick way to enter the lens adjustment setting; press the lens button on the local keypad or the remote control.

Access to the lens adjustments

1. Press **MENU** to activate the menus.
2. Use the ▲ or ▼ key to select *Alignment* and press **ENTER**.
3. Use the ▲ or ▼ key to select *Lens* and press **ENTER**.

The lens adjustment menu is displayed.

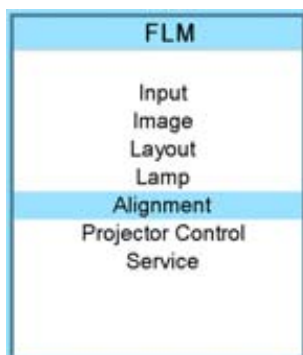

Image 12-4



Image 12-5

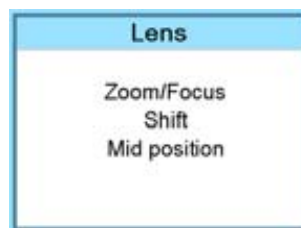

Image 12-6

Zoom/focus the lens

1. Use the ▲ or ▼ key to select *Zoom/Focus* and press **ENTER**.



Image 12-7

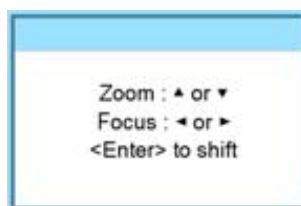

Image 12-8

12. Alignment menu

2. Use the ▲ or ▼ key to zoom the lens.
Use the ◀ or ▶ key to focus the lens.
3. Press **ENTER** to go to the shift adjustments.

Lens shift

1. Use the ▲ or ▼ key to select *Shift* and press **ENTER** or when in the Zoom/Focus menu press **ENTER** to toggle to the Shift menu.



Image 12-9



Image 12-10

2. Use the ▲ or ▼ key to shift the lens upwards or downwards.
Use the ◀ or ▶ key to shift the lens to the left or to the right.

Mid position

1. Use the ▲ or ▼ key to select *Mid position* and press **ENTER**.

The lens will move to its mid position. During this operation, a message is displayed: "Motor running ...".

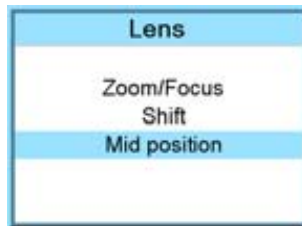

Image 12-11

12.4 Side keystone



Only available when the *Warp status* is *Off*.

What can be done?

The side keystone adjustment is used to align the image if the projector is mounted at a non standard projection angle.



Image 12-12
Side keystone



- A Keystone adjustment with positive values
- B Keystone adjustment with negative values

Side keystone adjustment

1. Press **MENU** to activate the menus.

2. Use the ▲ or ▼ key to select *Alignment* and press **ENTER**.
3. Use the ▲ or ▼ key to select *Side keystone* and press **ENTER**.

The keystone dialog box appears.

4. Use the ◀ or ▶ key to adjust the keystone of the image.

When the upper part of the image is wider than the lower part of the image, push the ◀ key. The value below the bar scale will be negative.

When the upper part of the image is smaller than the lower part of the image, push the ▶ key. The value below the bar scale will be positive.

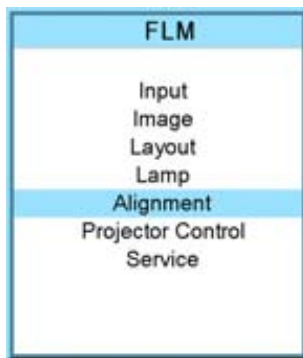

Image 12-13



Image 12-14



Image 12-15

12.5 Warp geometry settings



When the Warp geometry settings are used, the normal side keystone setting is disabled.

Overview

- About Warp geometry settings
- Warp Status
- Horizontal keystone correction
- Vertical keystone correction
- Rotation
- Pincushion - Barrel correction
- 4 corner correction
- Reset warp settings
- Load warp file

12.5.1 About Warp geometry settings

Warping

Image warping is the process of digitally manipulating an image such that any shapes portrayed in the image have been significantly distorted. Warping is used for correcting image distortion so that a correct image is displayed.

While an image can be transformed in various ways, pure warping means that points are mapped to points without changing the colors.

Some examples of projected images which need to be corrected with the warp geometry settings:



Image 12-16
Example 1 : distorted image



Image 12-17
Example 2 : distorted image



The Warp functions can slow down the switching from one source to another when Input locking is set to automatic and there is a difference in frequency between both sources.

12.5.2 Warp Status

Different modes

The warp distortion can have 3 states:

- Off : no warp distortion can be adjusted. Only the normal Side keystone can be used.
- Manual : the distortion functions inside the projector are available. Combinations of these adjustments can be used to correct the image. When using a setting to correct a part of the image, that can cause that other settings in the menu are grayed out. E.g. Using the keystone functions will gray out the 4 corners setting.
- File : an external created file is used to correct the image. More precise corrections are possible on a lot of more points in the image.

When switching the warp status from *Manual* or *File* to *Off* and back again, the latest used warp settings will be loaded again.

How to set the status

1. Press **MENU** to activate the menus.
2. Use the **▲** or **▼** key to select *Alignment* and press **ENTER**.
3. Use the **▲** or **▼** key to select *Warp* and press **ENTER**.
The warp dialog box appears.
4. Use the **▲** or **▼** key to select *Status* and press **ENTER** to toggle between [Manual], [File] or [Off]
 - [Manual] : projector functions for warp are available.
 - [File] : Sophisticated warp adjustments can be loaded via a file. The projector warp functions are not available.
 - [Off] : No warp adjustments used in the projected image.

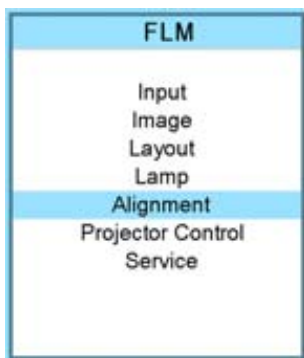

Image 12-18



Image 12-19

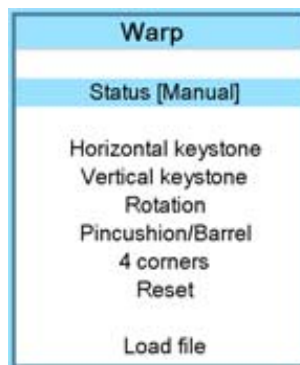

Image 12-20

12.5.3 Horizontal keystone correction

What can be done?

Horizontal keystone adjustment is used to align the image if the projector is mounted at a non standard projection angle. In some cases, horizontal keystone has to be used in combination with vertical keystone. When adjusting the keystone adjustment, the aspect ratio of the image is not changed.

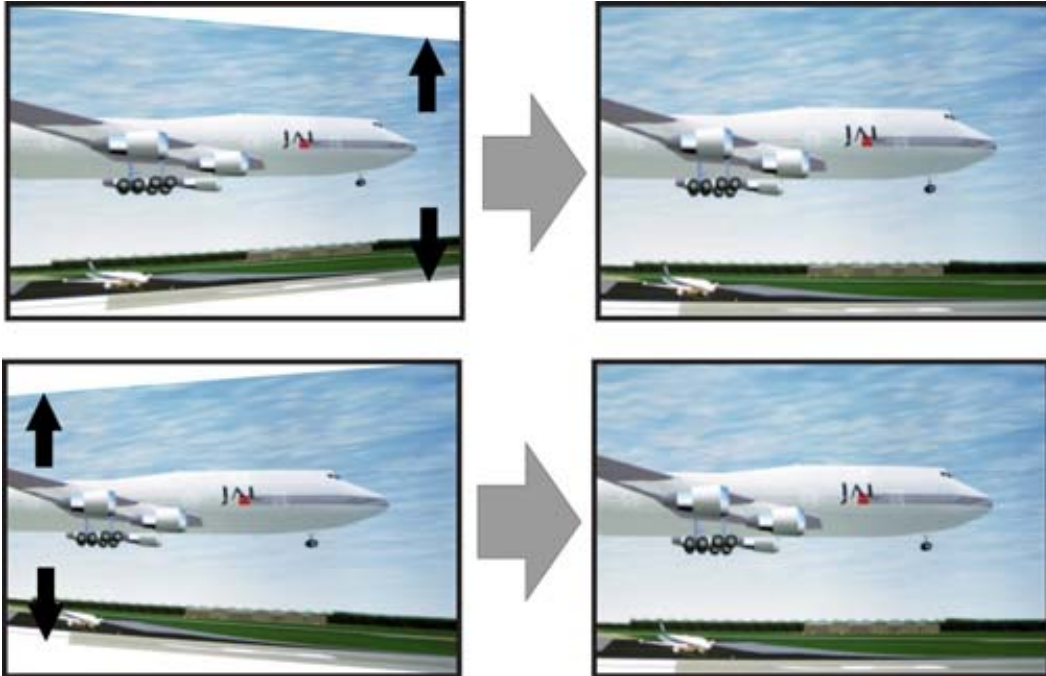

Image 12-21
Horizontal keystone correction

When the keystone is adjusted, the *4 corners* adjustment is disabled.

How to set the status

1. Press **MENU** to activate the menus.
2. Use the **▲** or **▼** key to select *Alignment* and press **ENTER**.
3. Use the **▲** or **▼** key to select *Warp* and press **ENTER**.
The warp dialog box appears.
4. Use the **▲** or **▼** key to select *Horizontal keystone* and press **ENTER**.
5. Use **◀** or **▶** to change the *horizontal keystone*.

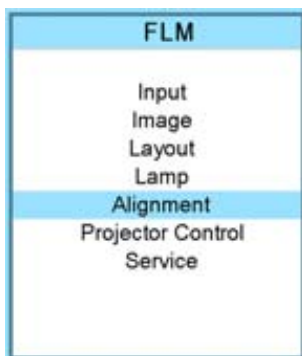

Image 12-22



Image 12-23

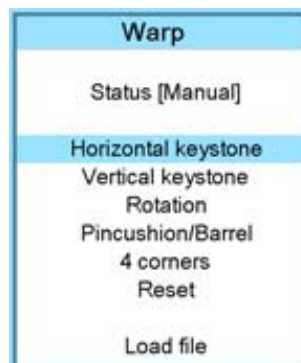

Image 12-24



Image 12-25

12.5.4 Vertical keystone correction

What can be done ?

Vertical keystone adjustment is used to align the image if the projector is mounted at a non standard projection angle. In some cases, vertical keystone has to be used in combination with horizontal keystone. When adjusting the keystone adjustment, the aspect ratio of the image is not changed.

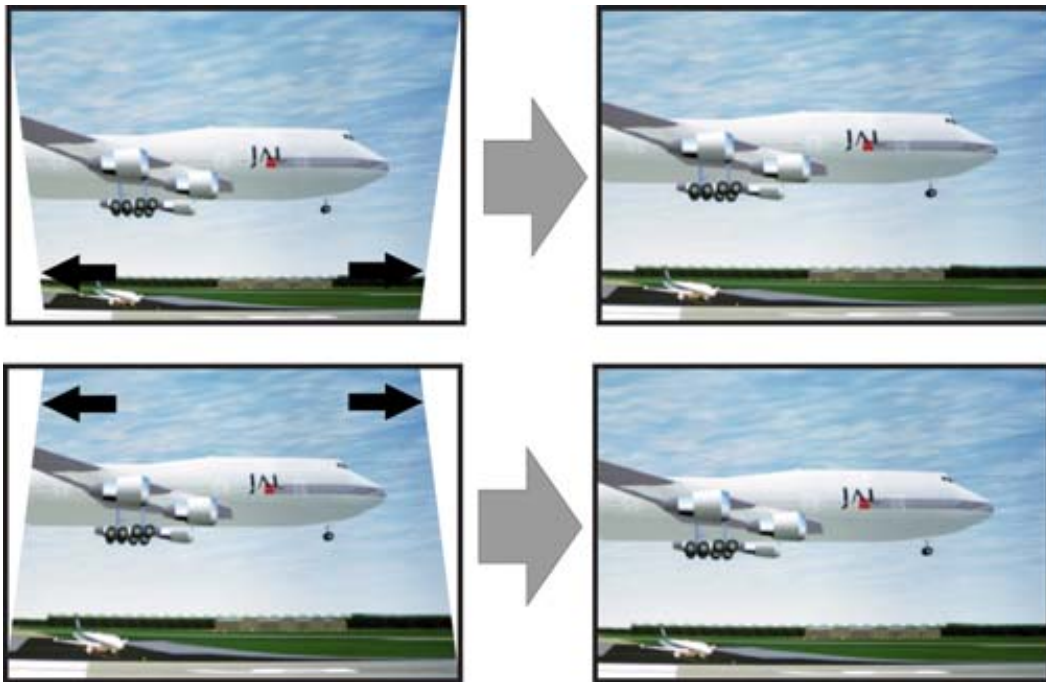

Image 12-26
Vertical keystone correction

When the keystone is adjusted, the *4 corners* adjustment is disabled.

How to set the status

1. Press **MENU** to activate the menus.
2. Use the **▲** or **▼** key to select *Alignment* and press **ENTER**.
3. Use the **▲** or **▼** key to select *Warp* and press **ENTER**.
The warp dialog box appears.
4. Use the **▲** or **▼** key to select *Vertical keystone* and press **ENTER**.
5. Use **◀** or **▶** to change the *vertical keystone*.

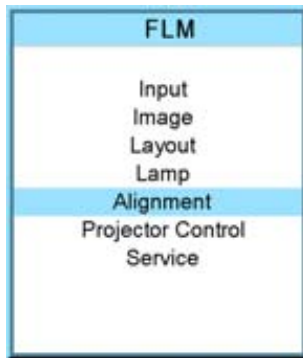

Image 12-27



Image 12-28

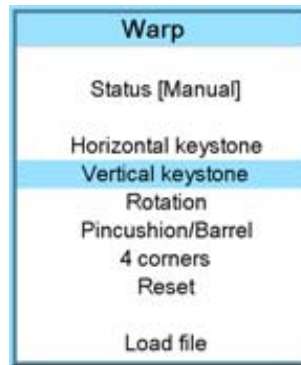

Image 12-29

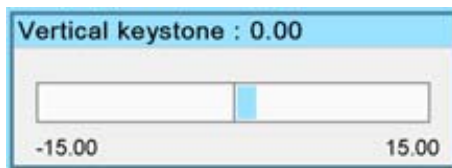
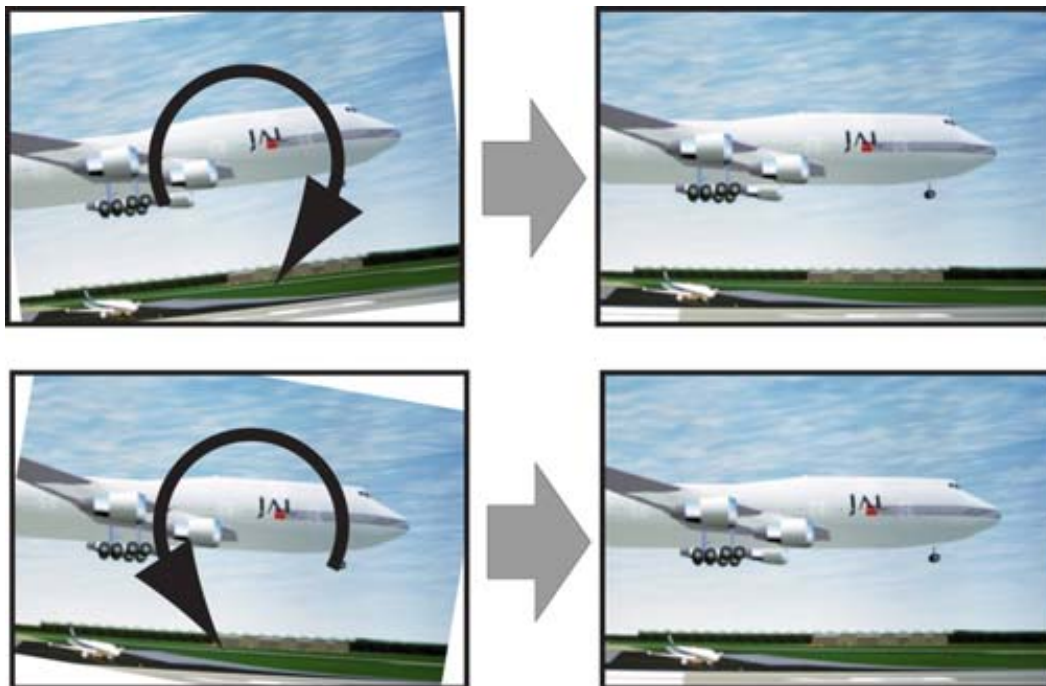

Image 12-30

12.5.5 Rotation

What can be done ?

A rotation is used to turn the image on the projection surface when the projector is slightly rotated around its axes.

Image 12-31
Rotation

How to rotate

1. Press **MENU** to activate the menus.
2. Use the **▲** or **▼** key to select *Alignment* and press **ENTER**.
3. Use the **▲** or **▼** key to select *Warp* and press **ENTER**.
The warp dialog box appears.
4. Use the **▲** or **▼** key to select *Rotation* and press **ENTER**.
5. Use **◀** or **▶** to change the *rotation angle*.

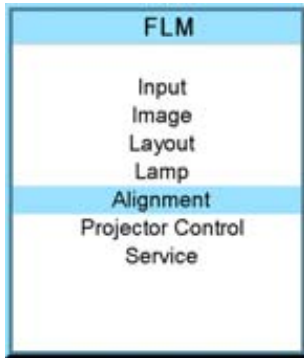

Image 12-32



Image 12-33

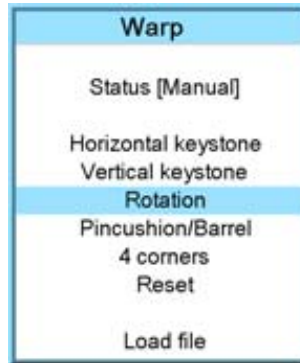

Image 12-34

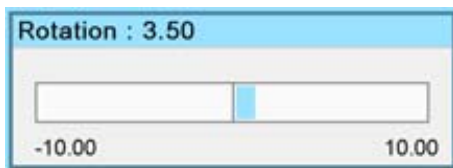

Image 12-35

12.5.6 Pincushion - Barrel correction

What can be done ?

A barrel distortion or pincushion distortion can be adjusted so that a normal image is displayed. Positive adjustments introduce more barrel distortion. Negative adjustments introduce more pincushion distortion.

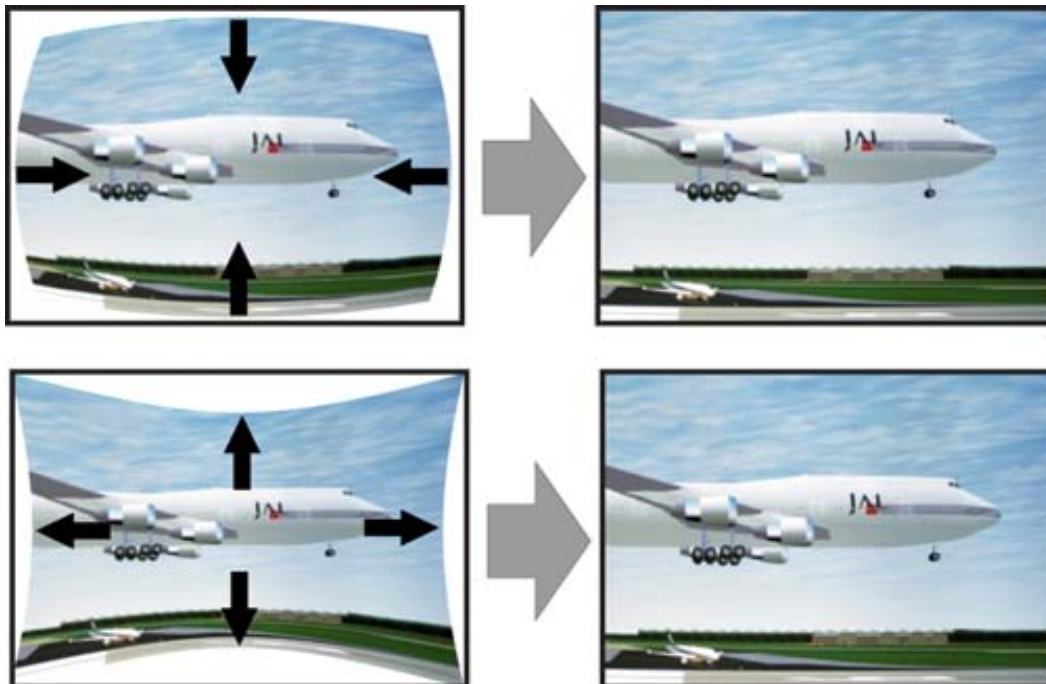

Image 12-36
Barrel and pincushion distortion

How to correct the distortion

1. Press **MENU** to activate the menus.
2. Use the **▲** or **▼** key to select *Alignment* and press **ENTER**.
3. Use the **▲** or **▼** key to select *Warp* and press **ENTER**.
The warp dialog box appears.
4. Use the **▲** or **▼** key to select *Pincushion/Barrel* and press **ENTER**.
5. Use **◀** or **▶** to adjust the pincushion or the barrel distortion.

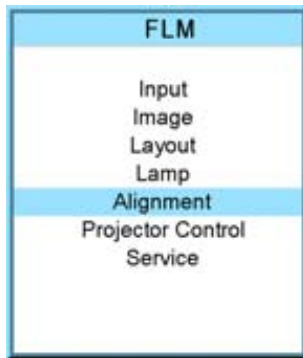

Image 12-37



Image 12-38

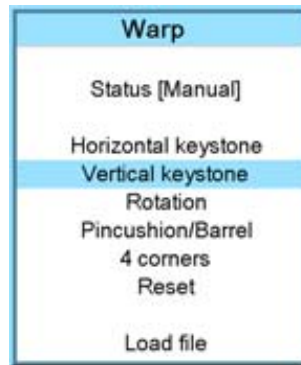

Image 12-39



Image 12-40

12.5.7 4 corner correction

What can be done ?

Each corner of the image can be moved individually in the X and Y direction to correct a distortion. Take in account that the aspect ratio can be changed while moving one of the corners.

The following adjustments are possible:

- Top left X
- Top left Y
- Top right X
- Top right Y
- Bottom left X
- Bottom left Y
- Bottom right X
- Bottom right Y

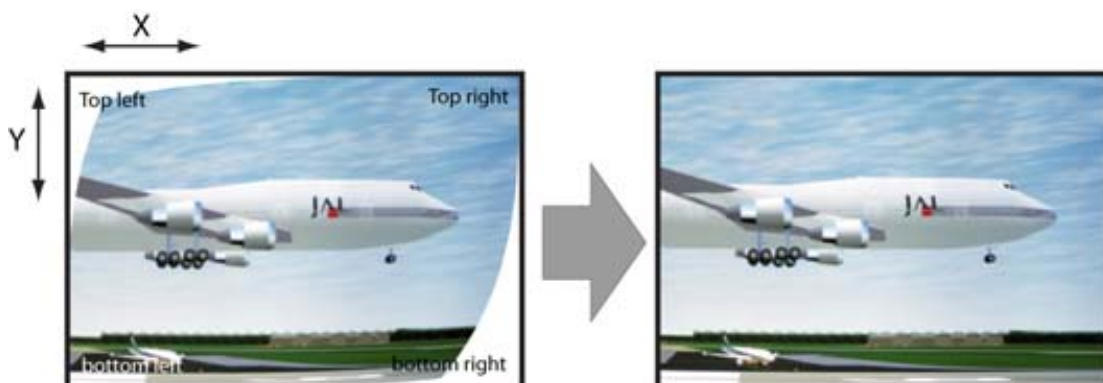

Image 12-41

Once an adjustment is done in one of the 4 corners, the horizontal and vertical keystone corrections are disabled.

How to move a corner

1. Press **MENU** to activate the menus.
2. Use the **▲** or **▼** key to select *Alignment* and press **ENTER**.
3. Use the **▲** or **▼** key to select *Warp* and press **ENTER**.
The warp dialog box appears.
4. Use the **▲** or **▼** key to select *4 corners* and press **ENTER**.

12. Alignment menu

5. Use the ▲ or ▼ key to select a corner and press **ENTER**.
6. Use ▲ or ▼ key to move the selected point in the X position and use ◀ or ▶ key to move the selected point in the Y position.

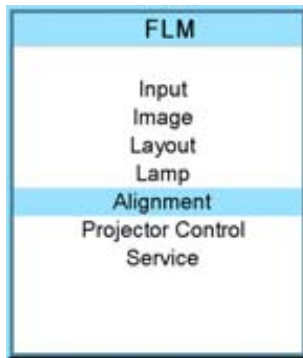

Image 12-42



Image 12-43

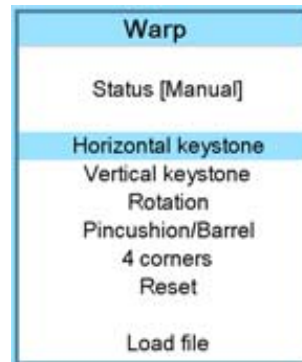

Image 12-44

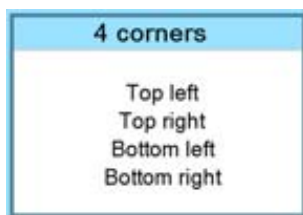

Image 12-45

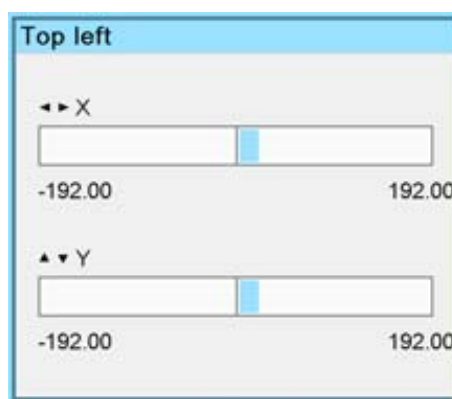

Image 12-46

12.5.8 Reset warp settings

What can be done ?

The current warp settings can be reset or returned to zero (0). At that moment all functions within the warping menu are available again.

How to correct the distortion

1. Press **MENU** to activate the menus.
2. Use the ▲ or ▼ key to select *Alignment* and press **ENTER**.
3. Use the ▲ or ▼ key to select *Warp* and press **ENTER**.
The warp dialog box appears.
4. Use the ▲ or ▼ key to select *Reset* and press **ENTER**.
All warp settings are reset. The *Status* is set to [Off].

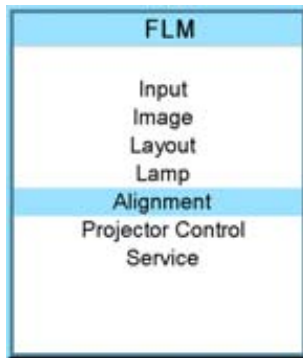

Image 12-47



Image 12-48

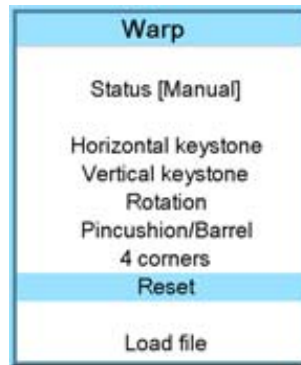

Image 12-49

12.5.9 Load warp file

What can be done ?

Special corrections which are not possible with the functions inside the projector are possible by loading a file which contains these corrections. This file should be created on an external computer and then stored on the projector using Projector Toolset. For more information about a free download of Projector Toolset, see "Free download of Projector Toolset", page 18.

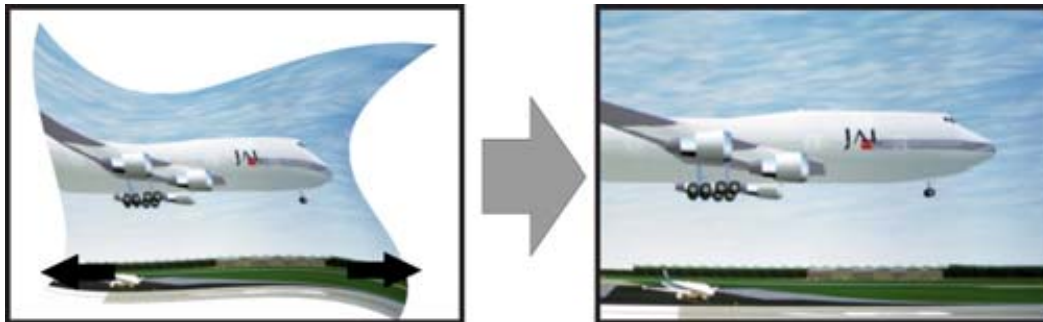

Image 12-50

How to load a file

1. Press **MENU** to activate the menus.
2. Use the **▲** or **▼** key to select *Alignment* and press **ENTER**.
3. Use the **▲** or **▼** key to select *Warp* and press **ENTER**.
The warp dialog box appears.
4. Use the **▲** or **▼** key to select *Load file* and press **ENTER**.
The load file menu opens
5. Use the **▲** or **▼** key to select the desired file out of the list and press **ENTER**.
The file is loaded and the corrections are applied.

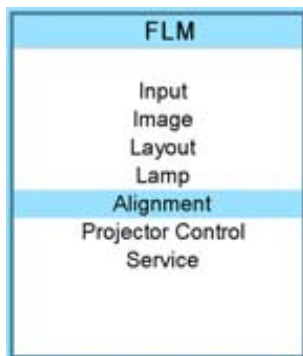

Image 12-51



Image 12-52

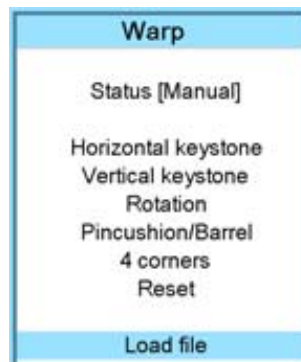

Image 12-53



Image 12-54

12.6 Contrast enhancement

Purpose

Increase the contrast for all video and data sources.

How to change

1. Press **MENU** to activate the menus.
2. Use the **▲** or **▼** key to select *Alignment* and press **ENTER**.
3. Use the **▲** or **▼** key to select *Contrast enhancement* and press **ENTER**.

The current selected contrast setting is indicated with an arrow.

4. Use the **▲** or **▼** key to select the desired setting and press **ENTER**.

The following settings are possible:

Normal contrast

High contrast

Custom any value between normal and high contrast can be selected.

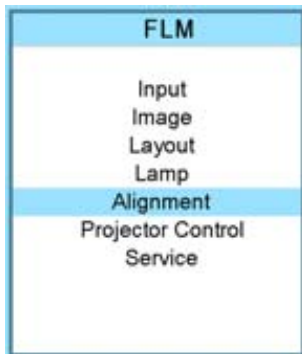

Image 12-55



Image 12-56



Image 12-57

5. When *Custom* is selected, the contrast menu is displayed.
6. Use the **▲** or **▼** key to select the desired adjustment and press **ENTER**. Press **EXIT** to return.

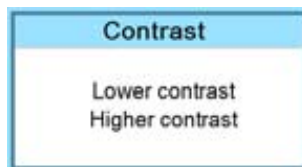

Image 12-58

12.7 Blanking

What can be done ?

Blanking adjustments affect only the edges of the projected image and are used to frame the projected image on to the screen and to hide or black out unwanted information (or noise). A '0' on the bar scale indicates no blanking.

Which blanking adjustments are available ?

- top blanking
- bottom blanking
- left blanking
- right blanking

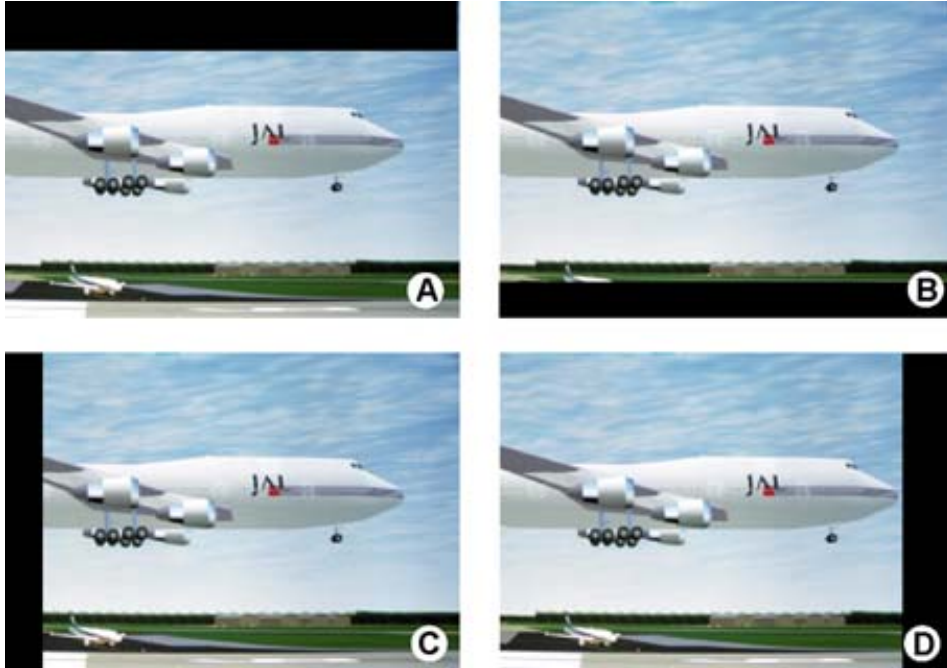

Image 12-59
Blanking

- A Top blanking
- B Bottom blanking
- C Left blanking
- D Right blanking

The reset function brings all blanking settings back to zero.

How to adjust the blanking?

1. Press **MENU** to activate the menus.
2. Use the **▲** or **▼** key to select *Alignment* and press **ENTER**.
3. Use the **▲** or **▼** key to select *Blanking* and press **ENTER**.
4. Use the **▲** or **▼** key to select the desired blanking adjustment and press **ENTER**.
5. Use the **▲** or **▼** key to adjust until the desired blanking is reached.
6. Press **EXIT** to return.

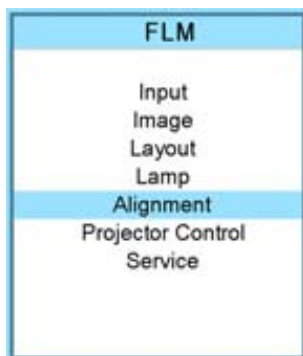

Image 12-60



Image 12-61

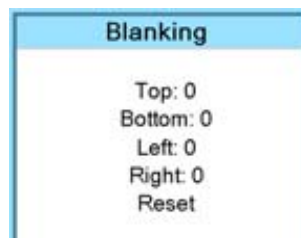

Image 12-62

12.8 Gamma

About Gamma

Gamma is an image quality enhancement function that offers a richer image by brightening the already darker portions of the image without altering the brightness of the brighter portions (contrast feeling enhanced).

How to adjust gamma?

1. Press **MENU** to activate the menus.
2. Use the **▲** or **▼** key to select *Alignment* and press **ENTER**.
3. Use the **▲** or **▼** key to select *Gamma* and press **ENTER**.
The Gamma progress bar appears.
4. Use **◀** or **▶** key to change the gamma setting and press **EXIT**.
Gamma can be set to one of the 8 available steps.

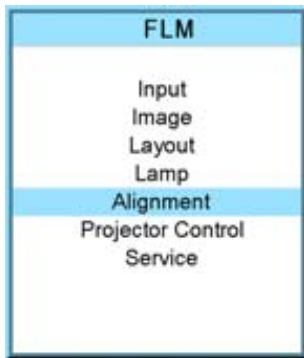

Image 12-63



Image 12-64

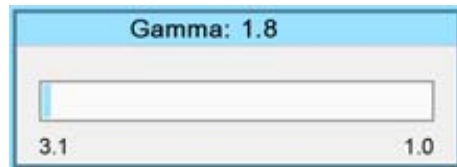

Image 12-65

12.9 Internal pattern

What can be done with these patterns?

The projector is equipped with different internal patterns which can be used for measurement and alignment purposes.

How to select?

1. Press **MENU** to activate the menus.
2. Use the **▲** or **▼** key to select *Alignment* and press **ENTER**.
3. Use the **▲** or **▼** key to select *Internal patterns* and press **ENTER**.
The internal patterns menu is displayed.
4. Use the **▲** or **▼** key to scroll through the possible selection and press **ENTER** to activate the selected pattern.
Select **▲** or **▼** in the menu to display the previous or next page with possible internal patterns.

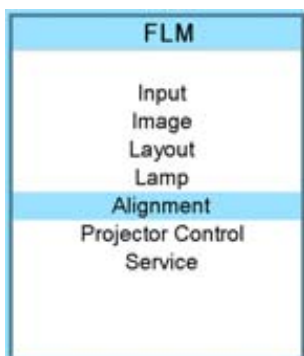

Image 12-66



Image 12-67

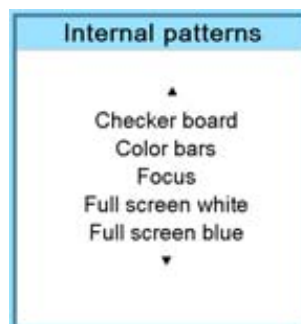

Image 12-68

The selected pattern is displayed.
The following patterns are available:

- Checker board
- Color bars
- Convergence
- Focus
- Full screen black
- Full screen blue
- Full screen green
- Full screen red
- Full screen white
- Hatch
- Outline
- Purity
- ScenergiX

12.10 Color space



Color space

A color space or color standard is a mathematical representation for a color. For example the RGB color space is based on a Cartesian coordinate system.

What can be adjusted ?

The color space (gamut), the collection of colors which can be reproduced by the projector, can be adjusted to 4 predefined stored values (one projector specific, 2 international standards and one custom preset). A temporary custom adjustment is possible. The maximum color space which can be displayed is the projector color space. This color space is measured at the factory and stored inside the projector.

How to select a color standard?

1. Press **MENU** to activate the menus.
2. Use the **▲** or **▼** key to select *Alignment* and press **ENTER**.
3. Use the **▲** or **▼** key to select *Color space* and press **ENTER**.
4. Use the **▲** or **▼** key to select the [On] or [Off] selection and **ENTER** to toggle color space on or off.
5. When color space is [On], use the **▲** or **▼** key to select the desired color standard and press **ENTER** to activate. Use the **►** key to view the details or to edit the details when Custom is selected.

Projector	Maximum color space
EBU	European Broadcasting Union. This organization defines a European standard.
SMPTE	American standard.
Custom	The user can define the x and y coordinates for red, green and blue which forms the corners of the color space. By changing the coordinates, the color reproduction can be changed.

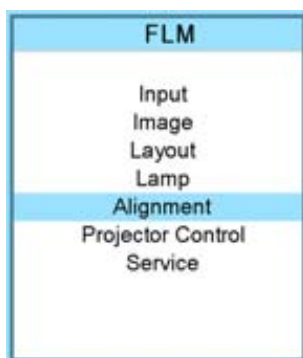

Image 12-69



Image 12-70

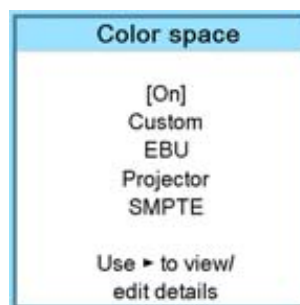

Image 12-71

12. Alignment menu

6. When custom is selected, use the ► key to view the details. To adjust the custom values, select the desired color point using the ▲ or ▼ key and change the value with ◀ or ▶ key until the desired value is reached. When finished, press **EXIT** to return.

Color space 'custom' details	
Red x	0.638
Red y	0.351
Green x	0.370
Green y	0.597
Blue x	0.146
Blue y	0.054
White y	0.340
Use ◀ or ▶ to change a value	

Image 12-72

12.11 ScenergiX

Overview

- Introduction
- Preparations
- ScenergiX activation
- ScenergiX overlap zone (horizontal ScenergiX)
- ScenergiX overlap zone (vertical ScenergiX)
- ScenergiX size adjustment (White level)
- Adjusting the black level of the images

12.11.1 Introduction

Why ScenergiX ?

When working in a multichannel setup the Projector Toolset and its Soft Edge possibilities enable an image blending that gives the appearance of a single view, thus achieving realistic immersion for the majority of wide screen applications.



Image 12-73
Why Soft Edge?

What is the Basic Principal of ScenergiX ?

The principle of edge blending is achieved by linear modulation of the light output in the overlap zone so that the light output in that zone equals the light output of the rest of the image.

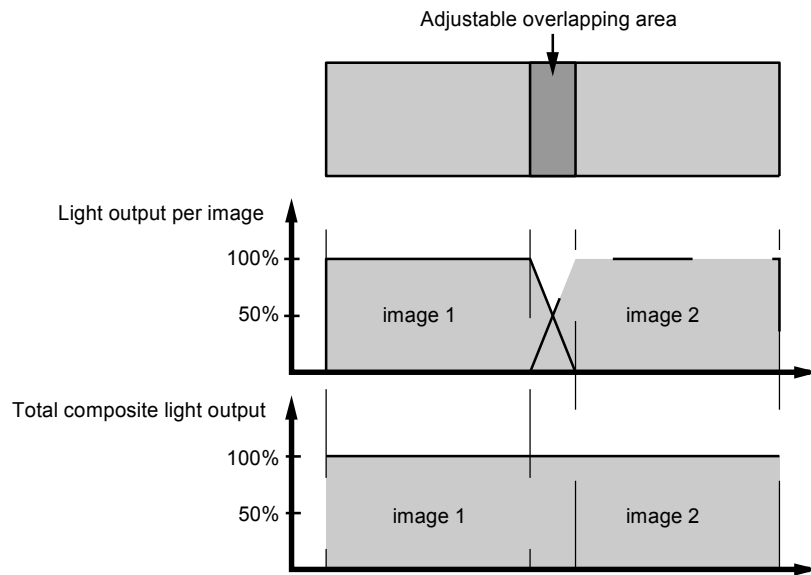

Image 12-74
ScenergiX Basic Principle

12.11.2 Preparations

ScenergiX Preparations

To ensure proper ScenergiX adjustment, be sure that the following adjustments are done perfectly on all projectors:

- Convergence
- Geometry
- Color Matching (Color Temperature, Color Standard, Input Balance, Gamma)

12.11.3 ScenergiX activation

How to activate?

1. Press **MENU** to activate the menus.
2. Use the **▲** or **▼** key to select *Alignment* and press **ENTER**.
3. Use the **▲** or **▼** key to select *ScenergiX* and press **ENTER**.
4. Use the **▲** or **▼** key to select *Status* and press **ENTER** to toggle between [On] and [Off].

- On ScenergiX is active
- Off ScenergiX is not active

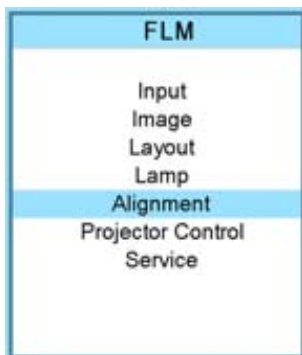

Image 12-75



Image 12-76

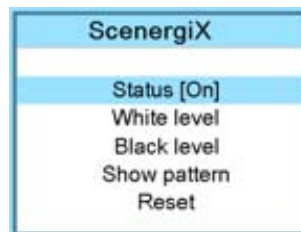

Image 12-77

12.11.4 ScenergiX overlap zone (horizontal ScenergiX)

Definitions

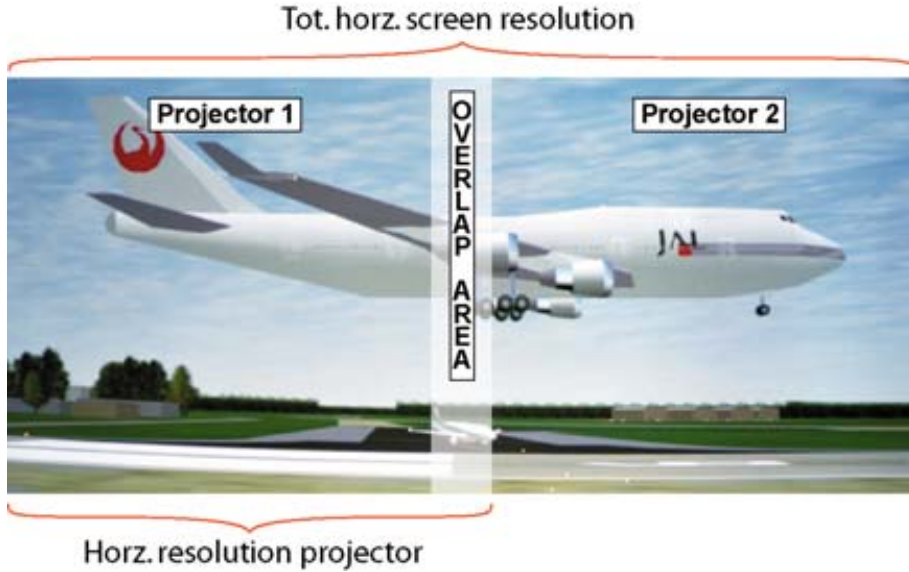

Image 12-78
ScenergiX set up

Overlap : number of pixels that overlap

Horizontal resolution of 1 projector

Total horizontal screen resolution : [(horizontal resolution of 1 projector) x 2] minus overlap.

Horizontal Resolution source : number of active pixels of the source.

How to set for the first projector

1. Go to *Layout* → *Main window* → *Size*
2. Enter the value for the Width as follow: Total horizontal screen resolution / 2 - 0.5 x overlap zone.
3. Position remains the same.

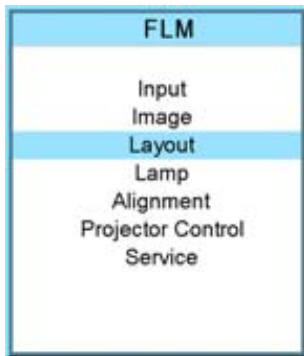

Image 12-79

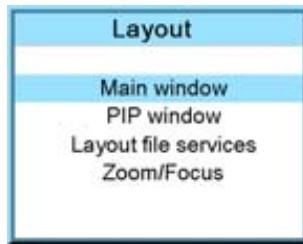

Image 12-80

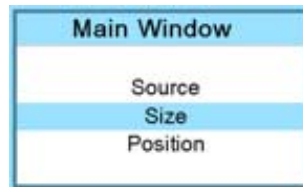

Image 12-81

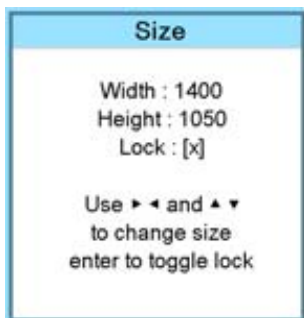

Image 12-82

How to set for the second projector

1. Go to *Layout* → *Main window* → *Size*
2. Enter the value for the Width as follow: Total horizontal screen resolution / 2 - 0.5 x overlap zone.
3. Position = original start + horizontal width of projector 1 - overlap zone

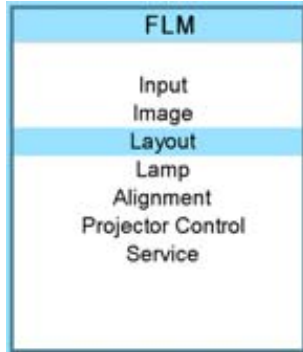

Image 12-83

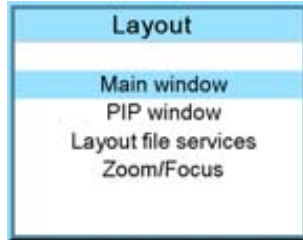

Image 12-84

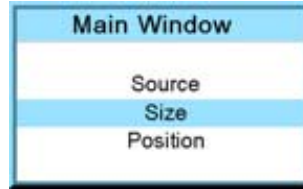

Image 12-85

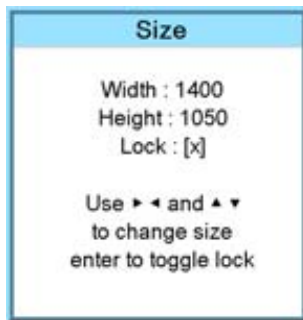

Image 12-86



Image 12-87

12.11.5 ScenergiX overlap zone (vertical ScenergiX)

Definitions

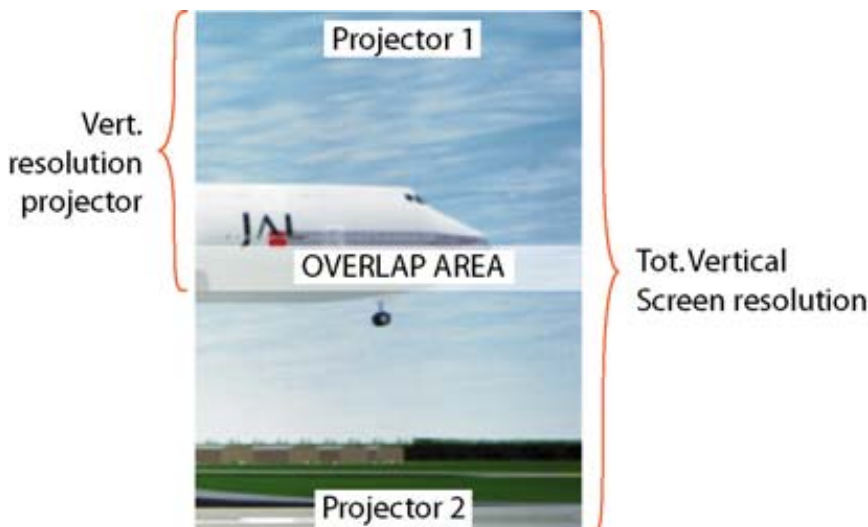

Image 12-88
Scenergix overlap zone vertical

Overlap : number of pixels that overlap

Vertical resolution of 1 projector

Total vertical screen resolution : [(Vertical resolution of 1 projector) x 2] minus (overlap)

Vertical Resolution source : number of active lines of the source

How to set for the first projector

1. Go to *Layout* → *Main window* → *Size*
2. Enter the value for the Height as follow: Total Vertical screen resolution / 2 - 0.5 x overlap zone.
3. Position remains the same.

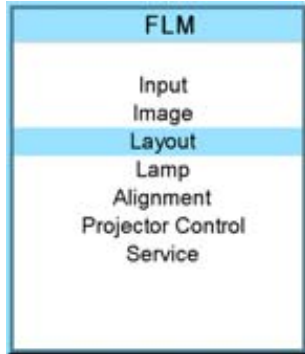

Image 12-89

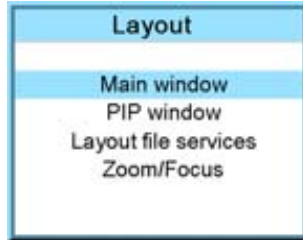

Image 12-90

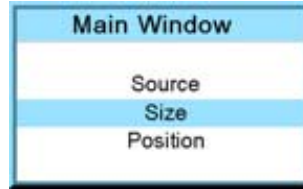

Image 12-91

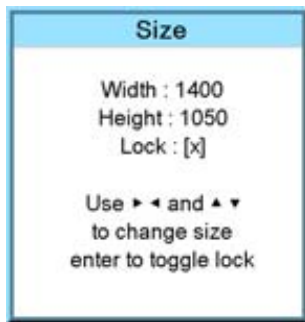

Image 12-92

How to set for the second projector

1. Go to *Layout* → *Main window* → *Size*
2. Enter the value for the Width as follow: Total Vertical screen resolution / 2 - 0.5 x overlap zone.
3. Position = original start + Vertical height projector 1 - overlap zone

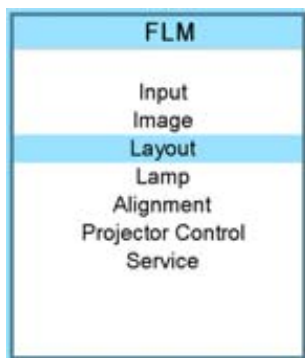

Image 12-93

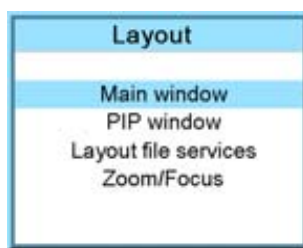

Image 12-94

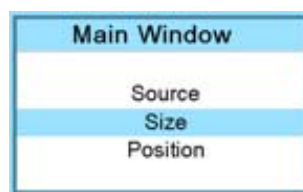

Image 12-95

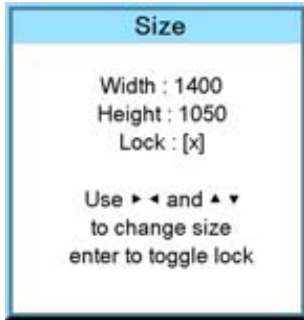

Image 12-96



Image 12-97

12.11.6 ScenergiX size adjustment (White level)

What can be done with the white level menu?

The white level menu contains top, bottom, left or right item to set the blending zone.



The ScenergiX menu items are only accessible when status is [On].

How to set the blending zone?

1. Press **MENU** to activate the menus.
2. Use the **▲** or **▼** key to select *Alignment* and press **ENTER**.
3. Use the **▲** or **▼** key to select *ScenergiX* and press **ENTER**.
4. Use the **▲** or **▼** key to select *White level* and press **ENTER**.
5. Use the **▲** or **▼** key to select one of the four size adjustments and press **ENTER**.

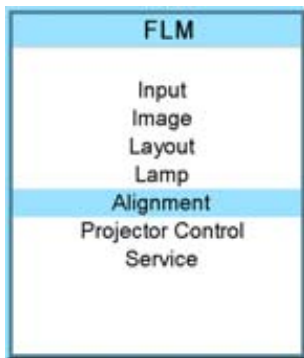

Image 12-98



Image 12-99

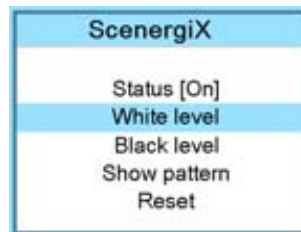

Image 12-100



Image 12-101

12. Alignment menu

A pattern with the different areas is displayed.

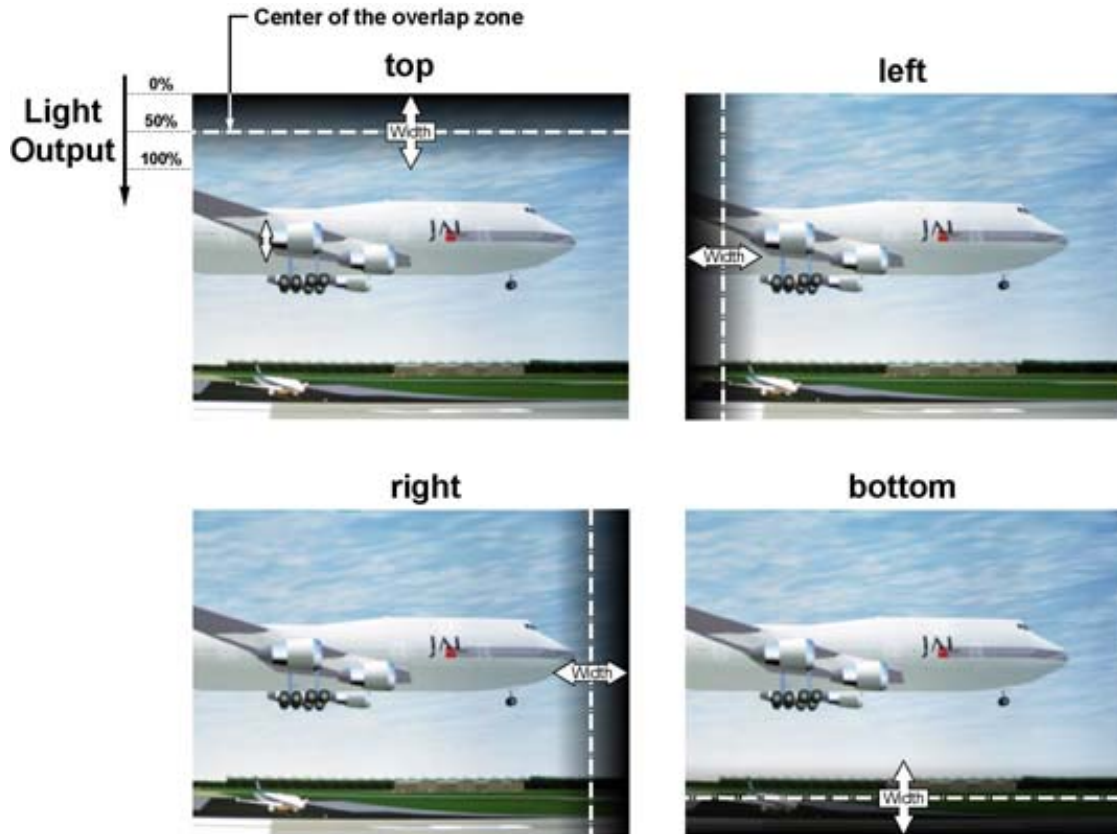

Image 12-102
Width selections

6. Use the cursor keys to move the border of the overlap area to the desired position. Set first the width for the first projector and repeat for the second one.

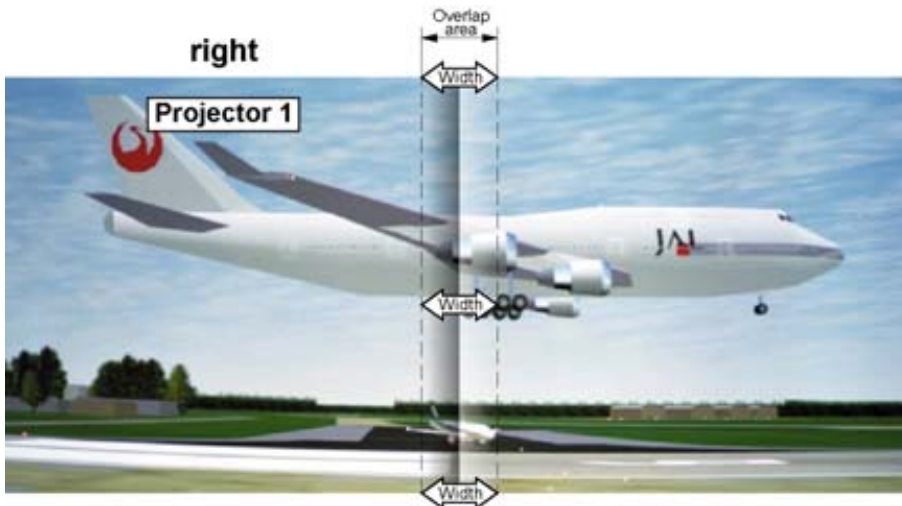

Image 12-103
Width set up for projector 1

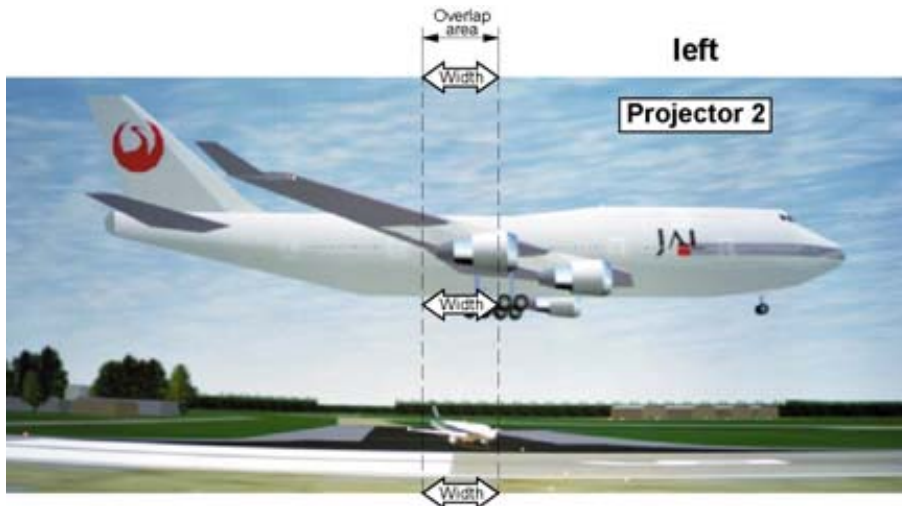

Image 12-104
Width set up for projector 2

12.11.7 Adjusting the black level of the images

Why black level adjustment

For dark images, the overlap zone will be brighter than the rest of the images. Typically for DLP projectors, next to the overlap zone, a brighter area is recognized. This area is known as a DLP leakage area. This area must also be excluded for the black level adjustment. Therefore we can rise the black level of the remaining image (excluding the overlap zone and the DLP leakage area).

First, the width of the leakage area must be set. The white cursor line indicates the border of the overlap area. The green cursor line indicates the current installed DLP leakage area border and starts at the position of the white cursor line (no width installed). This green line can be moved to the border of the DLP leakage area with the cursor keys.

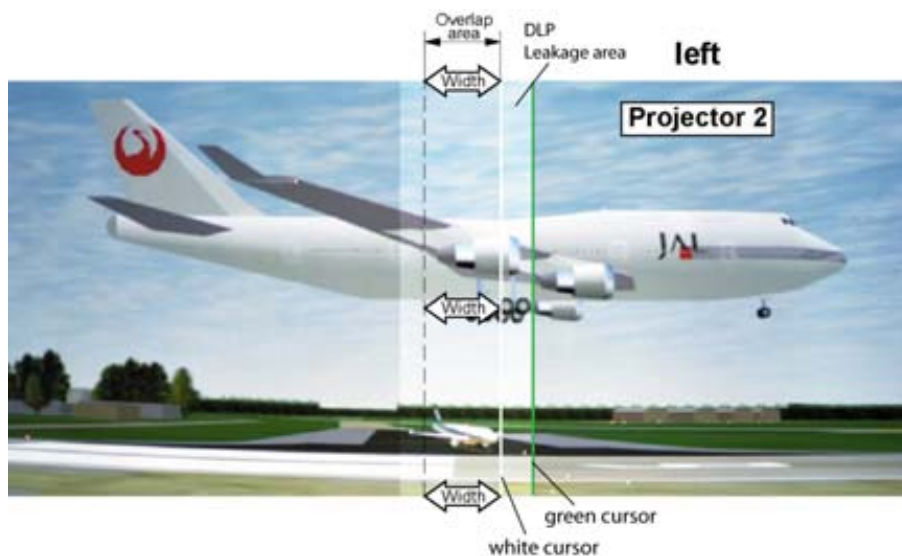

Image 12-105
DLP Leakage area set up



After the area is set, use **TEXT** key to remove the area border lines when adjusting the black level.

How to set the leakage area width

1. Press **MENU** to activate the menus.
2. Use the **▲** or **▼** key to select *Alignment* and press **ENTER**.
3. Use the **▲** or **▼** key to select *ScenergiX* and press **ENTER**.
4. Use the **▲** or **▼** key to select *Black level* and press **ENTER**.

12. Alignment menu

5. Use the ▲ or ▼ key to select one of the four size adjustments and press **ENTER**.

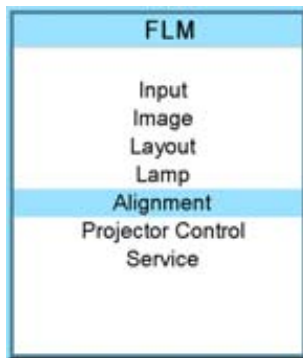

Image 12-106



Image 12-107

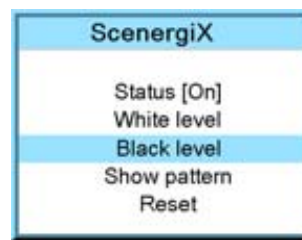

Image 12-108



Image 12-109

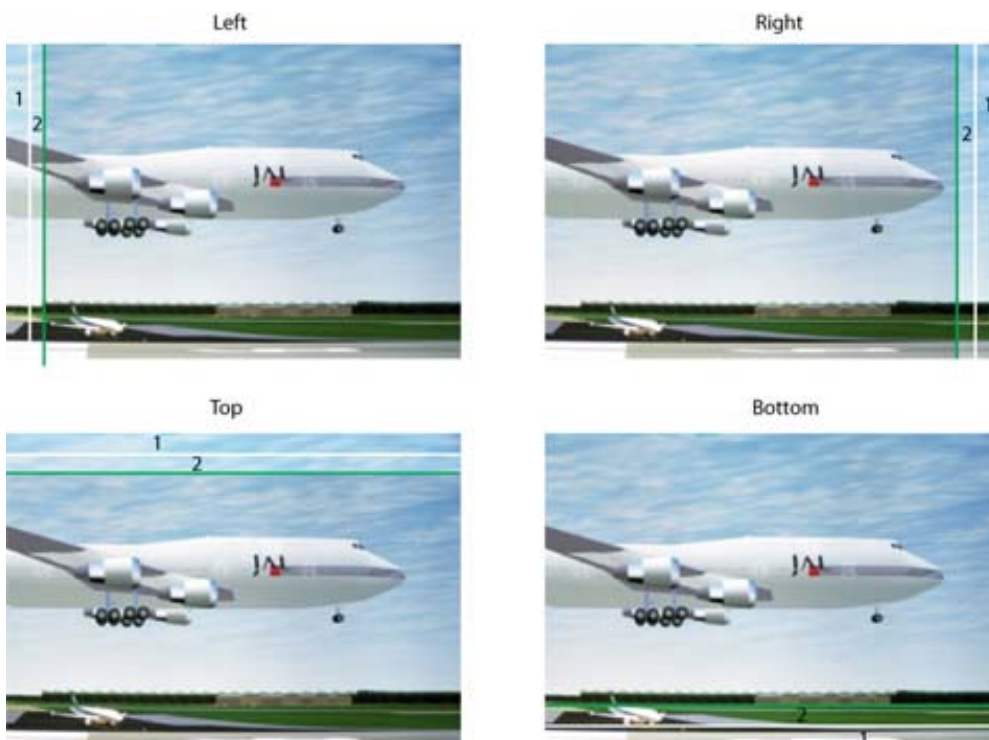

Image 12-110
DLP leakage area

- 1 Overlap area
- 2 DLP Leakage area

6. Use the cursor keys to move the green border line to the desired position.

The leakage area for this overlap is defined and will be excluded during black level adjustment.

How to adjust

1. Press **MENU** to activate the menus.
2. Use the **▲** or **▼** key to select *Alignment* and press **ENTER**.
3. Use the **▲** or **▼** key to select *ScenergiX* and press **ENTER**.
4. Use the **▲** or **▼** key to select *Black level* and press **ENTER**.

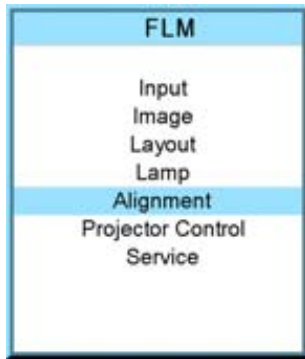

Image 12-111



Image 12-112

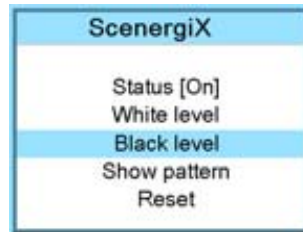

Image 12-113



Image 12-114

5. Adjust the black level of area A until the black level of area A, B and C are equal. Use the Adjust function All, Red, Green and Blue in the Black level menu.

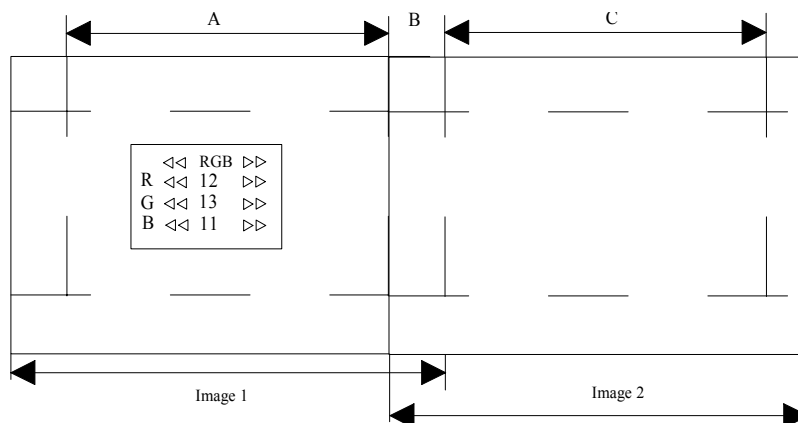

Image 12-115
Black level adjustment



Use the **Reset** function to bring all ScenergiX settings back to zero.

13. PROJECTOR CONTROL

About this chapter

This chapter explains the setup of the control part of the software such as projector address and all types of communication with the external world.

Overview

- Overview flow
- Projector address
- Serial communication
- Network
- IR control switching
- Art-Net DMX
- Buttons
- Menu position
- Local LCD
- Language selection

13.1 Overview flow

Overview

Level 1	Level 2	Level 3
Projector control	Projector address	Projector address Common address
	Serial communication	Baud rate [115200] Interface standard [RS232/RS422] RS422 termination [Off/On]
	Network	DHCP [ON/OFF] IP-address Subnet mask Default gateway
	IR control	IR Front [On/Off] IR Back [On/Off] IR Side [On/Off]
	ART DMX	DMX address DMX universe DMX monitor DMX mode [Basic/Extended/Full] Home lens at startup [No/Yes]
	Buttons	Standby APA

Level 1	Level 2	Level 3
		Shortcut keys
	Menu position	Menu Bar scale
	Local LCD	Local LCD time out Local LCD contrast
	Language	English Français Deutsch Español Italiano

13.2 Projector address

Overview

- Individual projector address
- Common address

13.2.1 Individual projector address

About individual projector address

Before a projector, and only this projector, can be controlled via a remote control, an individual address must be entered in the projector.

This individual projector address can then be used to control the projector via remote control or via a serial connection.

Next to an individual projector address, each projector has also a common address for group control.

How to set an individual address?

1. Press **MENU** to activate the menus.
2. Use the **▲** or **▼** key to select *Projector control* and press **ENTER**.
3. Use the **▲** or **▼** key to select *Projector address* and press **ENTER**.
4. Use the **▲** or **▼** key to select *Projector Address* and press **ENTER**.
The edit projector address window opens.
5. Use the **▲** or **▼** key to select a new value
Or,
enter a new value with the digit keys on the remote control or local keypad.
6. Use the **◀** or **▶** key to select the next digit and repeat step 5.
7. When the desired address is entered, press **ENTER** to store that address.

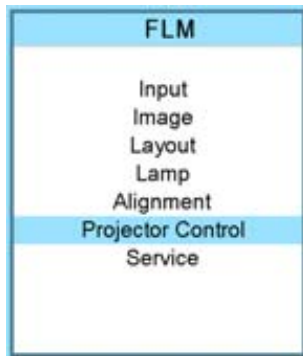

Image 13-1

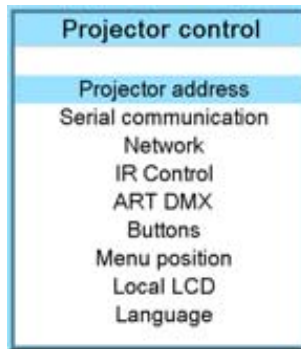

Image 13-2

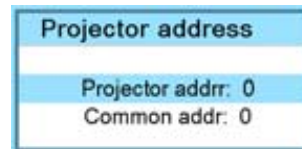

Image 13-3

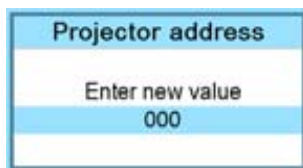

Image 13-4

13.2.2 Common address

About common address

A common address can be '0' or '1'.

Any command coming from a remote control programmed with that common address will be executed.

How to change the common address?

1. Press **MENU** to activate the menus.
2. Use the **▲** or **▼** key to select *Projector control* and press **ENTER**.
3. Use the **▲** or **▼** key to select *Projector address* and press **ENTER**.
4. Use the **▲** or **▼** key to select *Common address* and press **ENTER**.

The edit common address window opens.

5. Use the **▲** or **▼** key to select '0' or '1'
Or,
enter '0' or '1' with the digit keys on the remote control or local keypad.
6. When the desired address is entered, press **ENTER** to store that address.

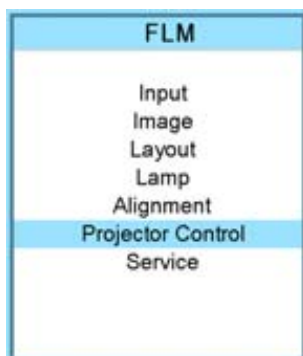

Image 13-5

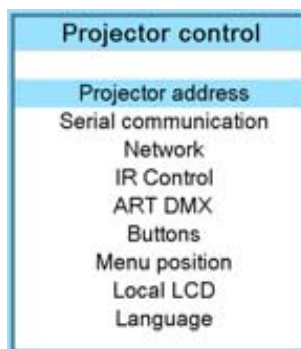

Image 13-6

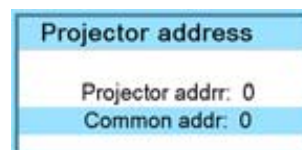

Image 13-7

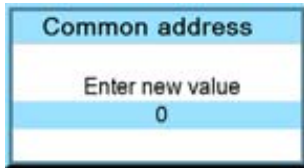

Image 13-8

13.3 Serial communication

Overview

- Baud rate setup
- Interface standard
- RS422 termination

13.3.1 Baud rate setup

What can be done?

The baudrate for a serial connection with a computer can be set up.

How to set up?

1. Press **MENU** to activate the menus.
2. Use the **▲** or **▼** key to select *Projector control* and press **ENTER**.
3. Use the **▲** or **▼** key to select *Serial communication* and press **ENTER**.
The serial communication menu opens.
4. Use the **▲** or **▼** key to select *Baudrate* and press **ENTER** to toggle between the available baud rates.
The following baud rates can be selected:
 - 9600
 - 19200
 - 38400
 - 57600
 - 115200
5. Press **EXIT** to return.

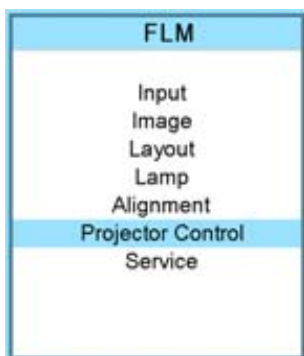

Image 13-9

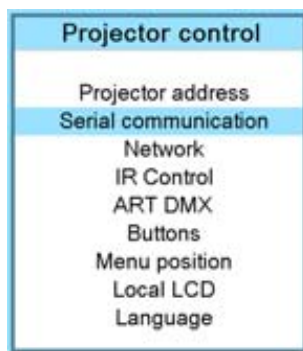

Image 13-10

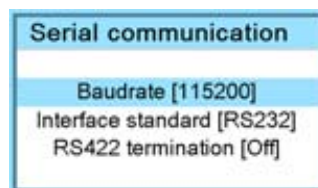

Image 13-11

13.3.2 Interface standard

What can be done?

The communication protocol for the communication between the projector and a computer can be set to RS232 or RS422.

How to set up

1. Press **MENU** to activate the menus.
2. Use the **▲** or **▼** key to select *Projector control* and press **ENTER**.

- Use the ▲ or ▼ key to select *Serial communication* and press **ENTER**.

The serial communication menu opens.

- Use the ▲ or ▼ key to select *Interface standard* and press **ENTER** to toggle between [RS232] or [RS422].

Default: [RS232]

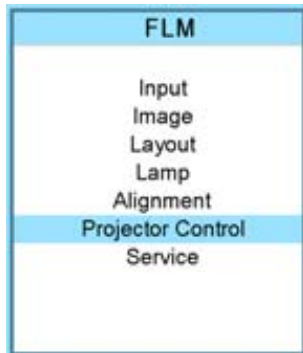

Image 13-12

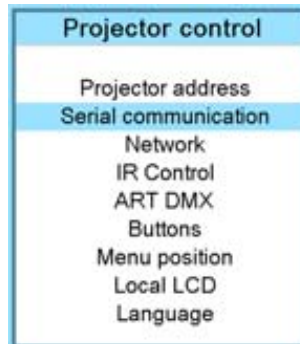

Image 13-13

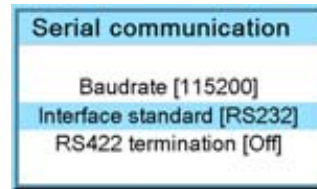

Image 13-14

13.3.3 RS422 termination

What can be done?

When the interface standard is set to RS422, the last projector in a line should be RS422 terminated (ON position). All others in the line should be in the OFF position.

How to set

- Press **MENU** to activate the menus.
- Use the ▲ or ▼ key to select *Projector control* and press **ENTER**.
- Use the ▲ or ▼ key to select *Serial communication* and press **ENTER**.

The serial communication menu opens.

- Use the ▲ or ▼ key to select *RS422 termination* and press **ENTER** to toggle between [On] or [Off].

Default: [On]

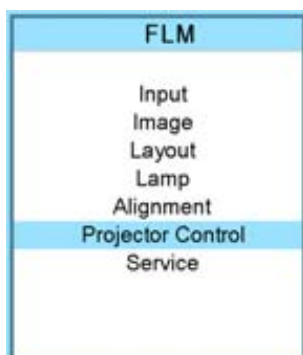

Image 13-15

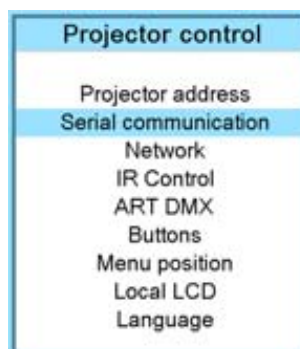

Image 13-16

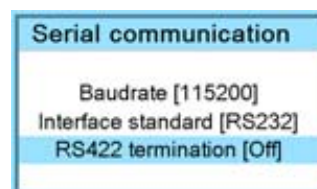

Image 13-17

13.4 Network

Overview

- Introduction to a Network connection
- DHCP setup
- IP-address set up
- Subnet-mask set up
- Default Gateway set up

13.4.1 Introduction to a Network connection



DHCP

Dynamic host configuration protocol. DHCP is a communications protocol that lets network administrators manage centrally and automate the assignment of IP addresses in an organization's network. Using the Internet Protocol, each machine that can connect to the Internet needs a unique IP address. When an organization sets up its computer users with a connection to the Internet, an IP address must be assigned to each machine. Without DHCP, the IP address must be entered manually at each computer and, if computers move to another location in another part of the network, a new IP address must be entered. DHCP lets a network administrator supervise and distribute IP addresses from a central point and automatically sends a new IP address when a computer is plugged into a different place in the network.



IP

Internet Protocol. The network layer of TCP/IP. Required for communication with the internet.



Subnet mask

A number that is used to identify a subnetwork so that IP addresses can be shared on a local area network.



Default Gateway

A router that serves as an entry point into and exit point out of a network. For example, a local network (LAN) may need a gateway to connect it to a wide area network (WAN) or to the Internet.



MAC address

Media Access Control address. Unique hardware number, used in combination with the IP-address to connect to the network (LAN or WAN).

What should be set up for an Ethernet address?

2 ways can be used to assign an address:

- use the DHCP setting so that an automatic address will be assigned.
- Assign manually an IP address, Net-mask (subnet-mask), (default) gateway address.
 - Set the IP-Address field to the desired value. This must NOT be 0.0.0.0 for static IP-Address assignment. The IP address identifies a projector's location on the network in the same way a street address identifies a house on a city block. Just as a street address must identify a unique residence, an IP address must be globally unique and have a uniform format.
 - Set the Subnet-Mask as appropriate for the local subnet.
 - Set the Default-Gateway to the IP-Address of the local router (MUST be on the local subnet!) on the same network as this projector that is used to forward traffic to destinations beyond the local network. This must not be 0.0.0.0. If there is no router on the projector's local subnet then just set this field to any IP-Address on the subnet.

13.4.2 DHCP setup

How to switch DHCP setting?

1. Press **MENU** to activate the menus.
2. Use the **▲** or **▼** key to select *Projector control* and press **ENTER**.
3. Use the **▲** or **▼** key to select *Ethernet* and press **ENTER**.

The Ethernet menu opens.

4. Use the **▲** or **▼** key to select *DHCP*.
5. Press **ENTER** to toggle the DHCP setting.

[ON] = DHCP is activated. Automatic assigning of an address is activated.

[OFF] = DHCP is deactivated. A fixed address will be used.

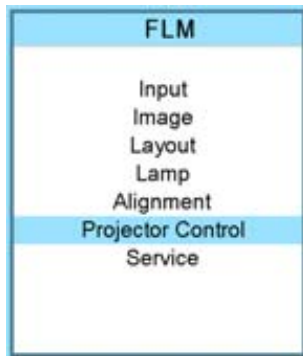

Image 13-18

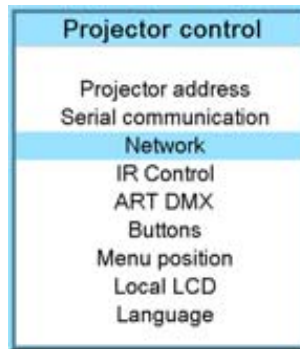

Image 13-19

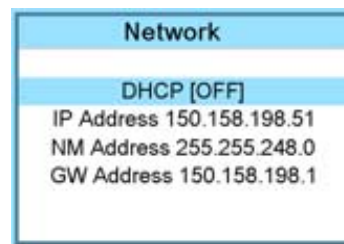

Image 13-20

13.4.3 IP-address set up

How to set up?

1. Press **MENU** to activate the menus.
2. Use the **▲** or **▼** key to select *Projector control* and press **ENTER**.
3. Use the **▲** or **▼** key to select *Network* and press **ENTER**.

The Network menu opens.

4. Use the **▲** or **▼** key to select *IP-address* and press **ENTER** to select.

Note: An address contains 4 octets with a maximum value of 255.

This must NOT be 0.0.0.0 for static IP-Address assignment.

5. Use the **▲** or **▼** key to select the desired digit and press **◀** or **▶** key to select the next digit in the address.
Or,
enter the value with the digit keys on the remote control or local keypad. The next digit in the address will be selected automatically.
6. Press **EXIT** to return.

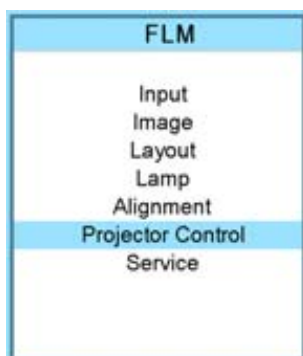

Image 13-21

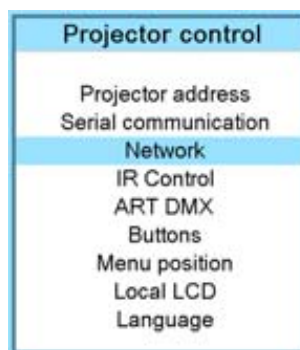

Image 13-22

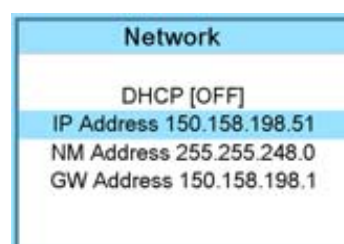

Image 13-23

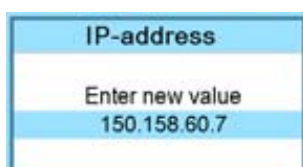

Image 13-24

13.4.4 Subnet-mask set up

How to set up?

1. Press **MENU** to activate the menus.

13. Projector control

- Use the ▲ or ▼ key to select *Projector control* and press **ENTER**.
- Use the ▲ or ▼ key to select *Network* and press **ENTER**.

The Ethernet menu opens.

- Use the ▲ or ▼ key to select *Subnet mask* and press **ENTER** to select.
Note: An address contains 4 octets with a maximum value of 255.

Fill out the 4 fields as appropriate for the local subnet.

- Use the ▲ or ▼ key to select the desired digit and press ◀ or ▶ key to select the next digit in the address.
Or,
enter the value with the digit keys on the remote control or local keypad. The next digit in the address will be selected automatically.
- Press **EXIT** to return.

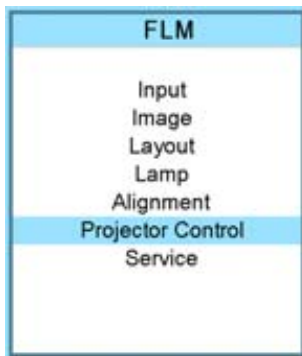

Image 13-25

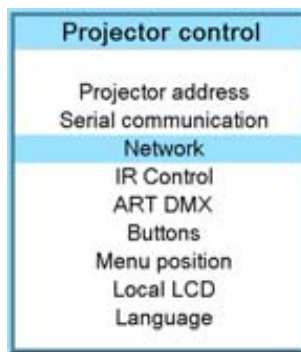

Image 13-26

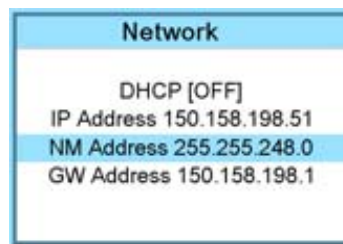

Image 13-27

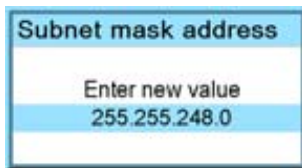

Image 13-28

13.4.5 Default Gateway set up

How to set up?

- Press **MENU** to activate the menus.
- Use the ▲ or ▼ key to select *Projector control* and press **ENTER**.
- Use the ▲ or ▼ key to select *Network* and press **ENTER**.

The Ethernet menu opens.

- Use the ▲ or ▼ key to select *Default Gateway* and press **ENTER** to select.
Note: An address contains 4 octets with a maximum value of 255.

Set the default gateway to the IP-address of the router (MUST be on the local subnet!). If there is no router on the projector's local subnet then just set this field to any IP-address on the subnet.

- Use the ▲ or ▼ key to select the desired digit and press ◀ or ▶ key to select the next digit in the address.
Or,
enter the value with the digit keys on the remote control or local keypad. The next digit in the address will be selected automatically.
Note: This must NOT be 0.0.0.0

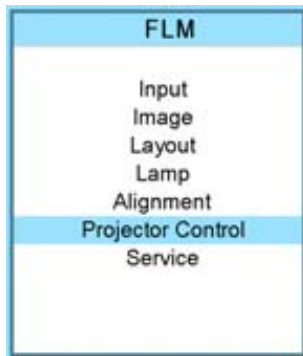

Image 13-29

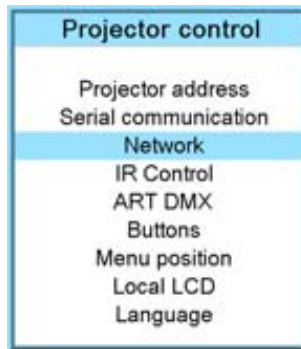

Image 13-30

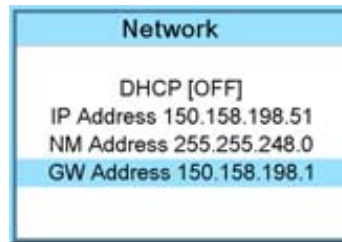

Image 13-31

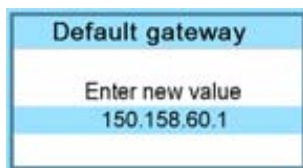

Image 13-32

6. Press **EXIT** to return.

13.5 IR control switching

What can be done?

Each IR receiver inside the projector can be activated or deactivated. When an IR receiver is deactivated, no IR signal send to this IR receiver will be processed.

How to switch

1. Press **MENU** to activate the menus.
2. Use the ▲ or ▼ key to select *Projector control* and press **ENTER**.
3. Use the ▲ or ▼ key to select *IR Control* and press **ENTER**.
4. Use the ▲ or ▼ key to select the desired IR receiver and press **ENTER** to toggle this receiver [on] or [off].

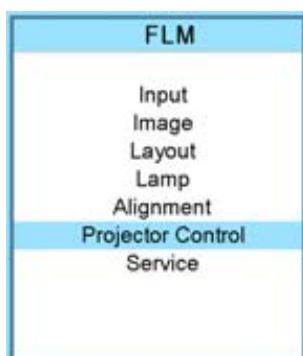

Image 13-33

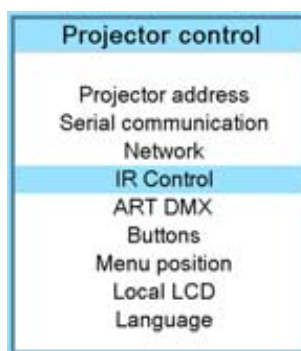

Image 13-34

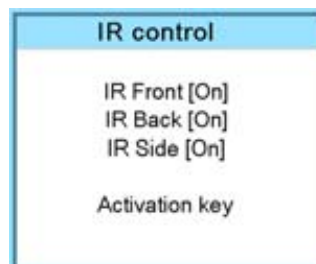

Image 13-35

13.6 Art-Net DMX



DMX

DMX-512 Lighting protocol, here used over Ethernet. Carries information of 512 channels from a lighting controller to lighting devices. Standardized by USITT.

Overview

- DMX address
- DMX universe
- DMX monitor
- DMX mode
- Art-Net activation
- Home lens at startup

Art-Net DMX

When using a DMX console compatible with Art-Net, the Ethernet network serves as the link for DMX control.

Make sure that your lighting desk and all projectors are within the same IP address range. It can be necessary to set DHCP to [Off] for each projector and to enter an IP address manually which is in the IP address range of the lighting console.

13.6.1 DMX address

What should be done ?

Before a projector can execute DMX commands, a unique address, called DMX address, should be given to the projector. This address can vary from 0 to 512.

How to set a DMX address

1. Press **MENU** to activate the menus.
2. Use the **▲** or **▼** key to select *Projector control* and press **ENTER**.
3. Use the **▲** or **▼** key to select *ART DMX* and press **ENTER**.
4. Use the **▲** or **▼** key to select *DMX address* and press **ENTER**.
The edit DMX address window opens.
5. Use the **▲** or **▼** key to select a new value
Or,
enter a value with the digit keys on the remote control or local keypad.
6. Use the **◀** or **▶** key to select the next digit and repeat step 5.
7. When the desired address is entered, press **ENTER** to store that address.

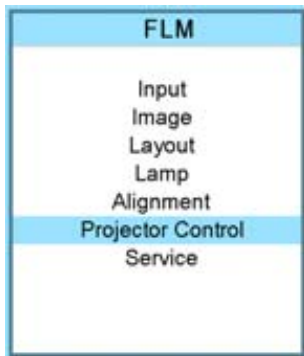

Image 13-36

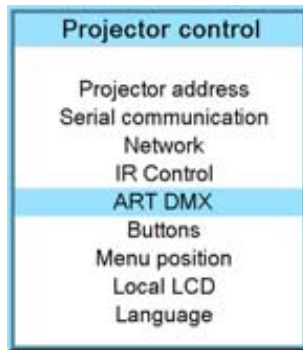

Image 13-37

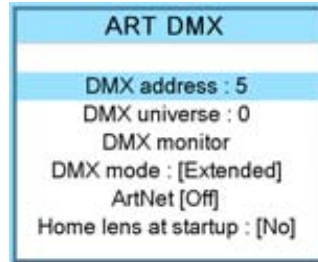

Image 13-38

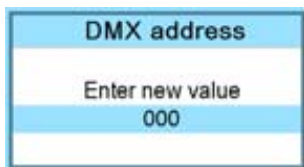

Image 13-39

13.6.2 DMX universe

What can be done ?

Depending on the DMX mode, one DMX universe can contain a different number of projectors. E.g. DMX mode = basis, the DMX universe can contain up to 256 projectors

How to set a DMX universe

1. Press **MENU** to activate the menus.
2. Use the **▲** or **▼** key to select *Projector control* and press **ENTER**.
3. Use the **▲** or **▼** key to select *ART DMX* and press **ENTER**.
4. Use the **▲** or **▼** key to select *DMX universe* and press **ENTER**.
5. Use the **▲** or **▼** key to select a new value
Or,
enter a value with the digit keys on the remote control or local keypad.
6. Use the **◀** or **▶** key to select the next digit and repeat step 5.
7. When the desired universe value is entered, press **ENTER** to store that value.

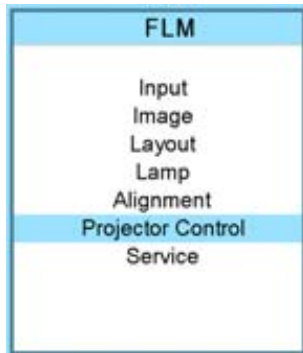

Image 13-40

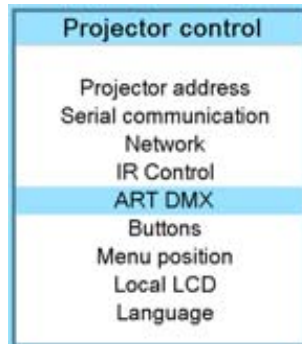

Image 13-41

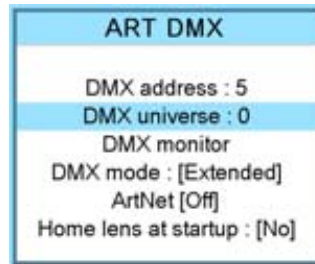

Image 13-42

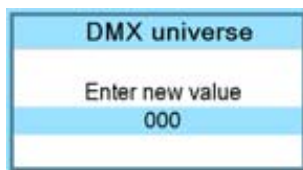

Image 13-43

13.6.3 DMX monitor

What can be done ?

If a DMX device is connected, the settings per channel can be displayed in an on screen menu.

How to start up the monitoring

1. Press **MENU** to activate the menus.
2. Use the **▲** or **▼** key to select *Projector control* and press **ENTER**.
3. Use the **▲** or **▼** key to select *ART DMX* and press **ENTER**.
4. Use the **▲** or **▼** key to select *DMX monitor* and press **ENTER**.

The *DMX monitor* window opens. Depending on the DMX mode, a different view of the DMX monitor window opens.

Example in dialog box is Extended mode

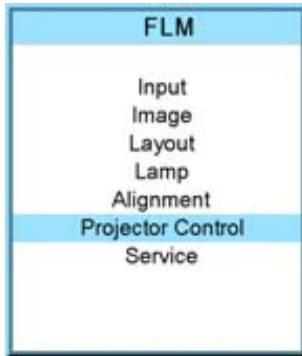

Image 13-44

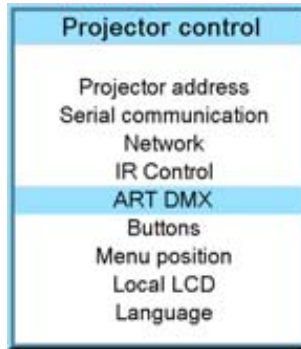

Image 13-45

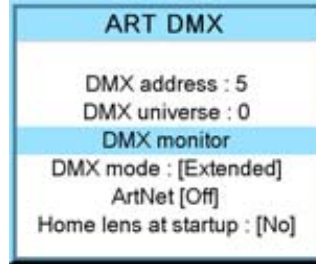

Image 13-46

DMX Monitor		
Channel	Function	Parameter
1	Intensity	0 - 100%
2	Brightness	0 - 100%
3	Contrast	0 - 100%
4	Input select	Select between Input1 ,Input2...
5	Lens control	Shift up down, left ...
6	Focus	Coarse adjust
7	Focus	Fine adjust
8	Zoom	Coarse adjust

Image 13-47



When selecting *DMX monitor* and no DMX device is connected, the message “*No DMX data, check connection <ENTER> to display channels*” appears on the screen. When ENTER is pressed the same window appears as DMX Monitor but without values.

13.6.4 DMX mode

What can be done ?

3 modes for DMX are available:

- Basic which has currently 2 channels implemented.
- Extended which has currently 10 channels implemented
- Full which has currently 9 channels implemented and 10th free channel.

Depending on the DMX application the correct mode has to be selected.

For the complete DMX chart of each mode, see "DMX chart", page 207.

How to set the mode

1. Press **MENU** to activate the menus.
2. Use the ▲ or ▼ key to select *Projector control* and press **ENTER**.
3. Use the ▲ or ▼ key to select *ART DMX* and press **ENTER**.
4. Use the ▲ or ▼ key to select *DMX mode* and press **ENTER** to toggle between [basic], [extended] or [full].

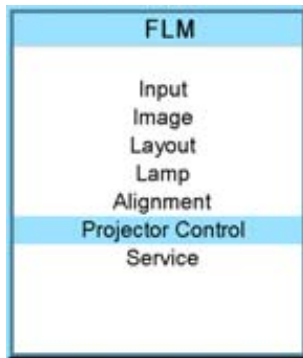

Image 13-48

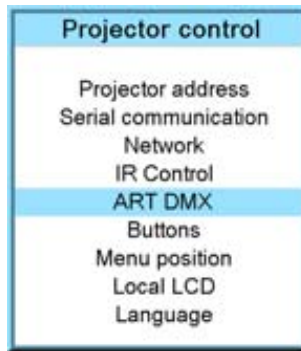

Image 13-49

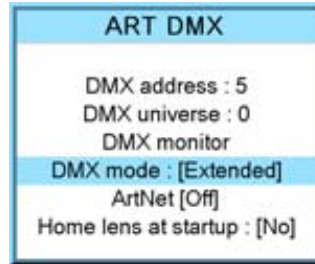

Image 13-50

13.6.5 Art-Net activation

What can be done ?

DMX via Art-Net can be activated [On] or blocked [Off].

Default value : off

How to toggle

1. Press **MENU** to activate the menus.
2. Use the ▲ or ▼ key to select *Projector control* and press **ENTER**.
3. Use the ▲ or ▼ key to select *ART DMX* and press **ENTER**.
4. Use the ▲ or ▼ key to select *ArtNet* and press **ENTER** to toggle between [Off] or [On].

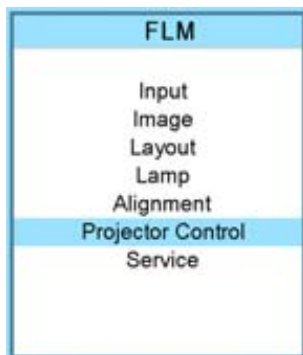

Image 13-51

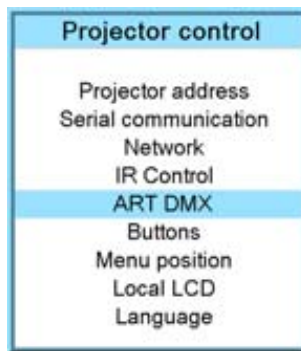

Image 13-52

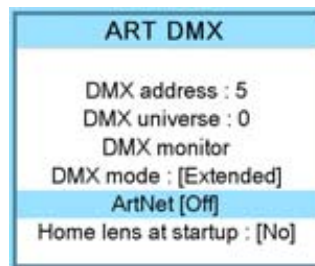

Image 13-53

13.6.6 Home lens at startup

What can be done ?

At power On the lens will search for its minimum and its maximum position. These minimum and maximum values will be used during this sessions to control the lens exactly. Once the lens limits are found, the lens returns to original position.

This full process takes about 3 to 4 minutes. During the homing cycle, all functions in the projector are blocked.

How to set

1. Press **MENU** to activate the menus.
2. Use the ▲ or ▼ key to select *Projector control* and press **ENTER**.
3. Use the ▲ or ▼ key to select *ART DMX* and press **ENTER**.
4. Use the ▲ or ▼ key to select *Home lens at startup* and press **ENTER** to toggle between [On] or [Off].

13. Projector control

[On] : home lens will be executed during power on.

[Off] : home lens will not be executed during power on.

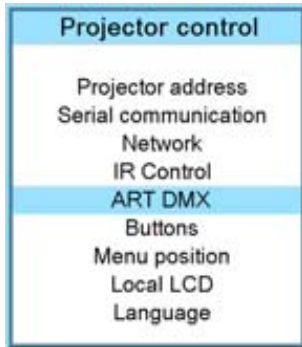

Image 13-54

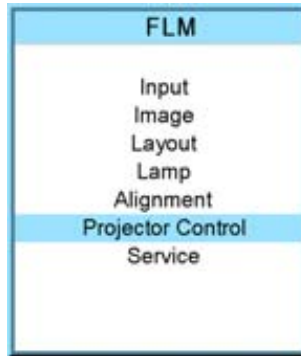

Image 13-55

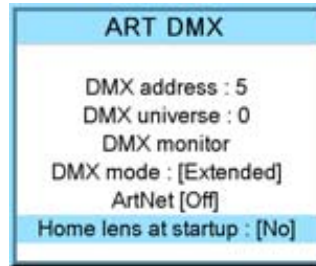

Image 13-56

13.7 Buttons

Functionality

Some buttons on the RCU or local keypad can have a different functionality depending on the need of the projector owner.

Overview

- Standby button
- APA (auto) button
- Shortcut keys

13.7.1 Standby button

What is possible?

When going to standby by pressing the standby button, the following can happen:

- Only the lamp will be switched off.
- The lamp and the power will be switched off.

How to set

1. Press **MENU** to activate the menus.
2. Use the **▲** or **▼** key to select *Projector control* and press **ENTER**.
3. Use the **▲** or **▼** key to select *Buttons* and press **ENTER**.
4. Use the **▲** or **▼** key to select *Standby* and press **ENTER** to toggle between *[Lamp on/off]* and *[Power up/down]*.

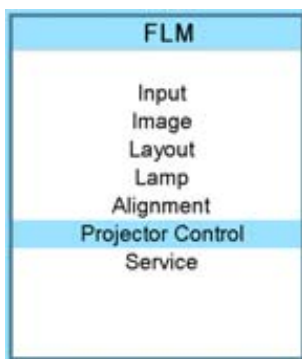

Image 13-57

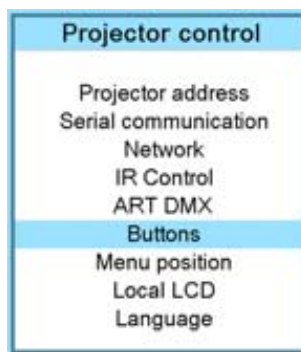

Image 13-58

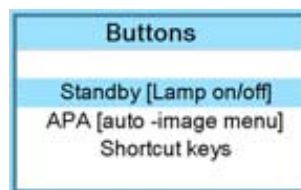

Image 13-59

13.7.2 APA (auto) button

What can be done?

The function of the APA (auto) button can be configured according to the wishes of the user.

The function can be:

- Align only (only aligning of the preview window is executed)
- Auto-image menu. This function opens an auto image menu where the user can make his choice between auto align, auto contrast/brightness and auto phase.

How to configure the APA (auto) button

1. Press **MENU** to activate the menus.
2. Use the **▲** or **▼** key to select *Projector control* and press **ENTER**.
3. Use the **▲** or **▼** key to select *Buttons* and press **ENTER**.
4. Use the **▲** or **▼** key to select *APA* and press **ENTER** to toggle between *[Align only]* and *[Auto-image menu]*.

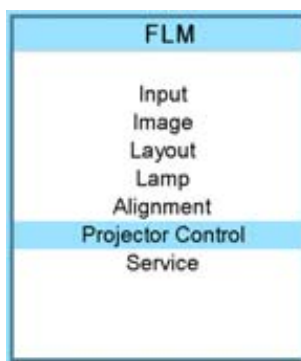

Image 13-60

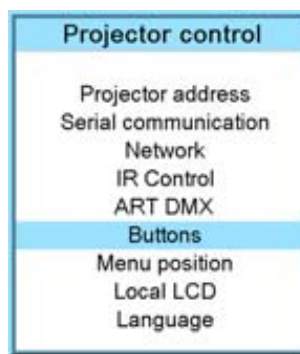

Image 13-61

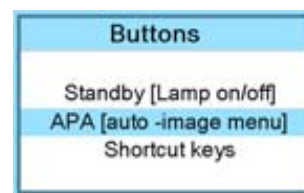

Image 13-62

13.7.3 Shortcut keys

What can be done?

An overview of the shortcut allocations with the corresponding menu is given. Those printed in bold are allocated.

The allocated shortcut keys can be cleared within this menu.

How to clear a shortcut key

1. Press **MENU** to activate the menus.
2. Use the **▲** or **▼** key to select *Projector control* and press **ENTER**.
3. Use the **▲** or **▼** key to select *Buttons* and press **ENTER**.
4. Use the **▲** or **▼** key to select *Shortcut keys* and press **ENTER**.
5. Use the **▲** or **▼** key to select a shortcut with allocation and press **ENTER** to remove the allocation.

The indication becomes *No allocation* and the key is free again for a new shortcut association.

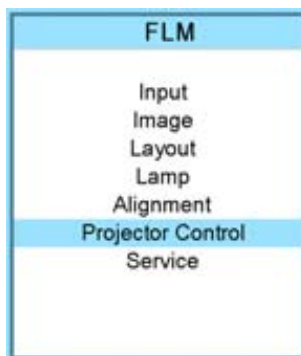

Image 13-63



Image 13-64

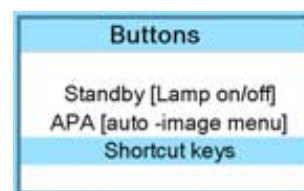

Image 13-65

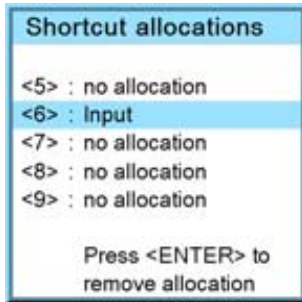

Image 13-66

13.8 Menu position

Overview

- On screen menu
- Bar scale

13.8.1 On screen menu

What is possible?

The on screen menu can be positioned on 3 different places on the screen but always vertically centered on the screen.

The horizontal position can be:

- Centered
- Top aligned
- Bottom aligned

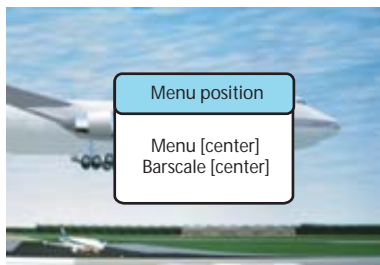
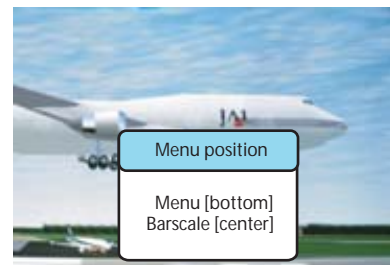
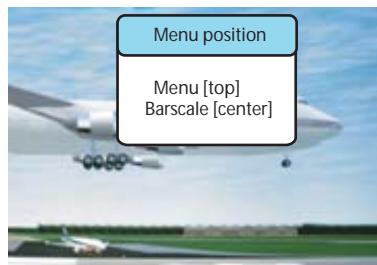

Image 13-67
Menu position



How to change the position

1. Press **MENU** to activate the menus.
2. Use the **▲** or **▼** key to select *Projector control* and press **ENTER**.
3. Use the **▲** or **▼** key to select *Menu position* and press **ENTER**.
4. Use the **▲** or **▼** key to select *Menu* and press **ENTER** to toggle between *[Center]*, *[Top]* and *[Bottom]*.

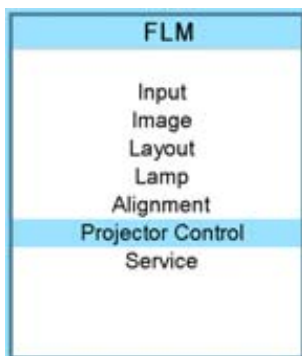

Image 13-68

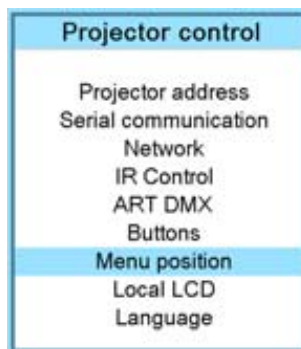

Image 13-69

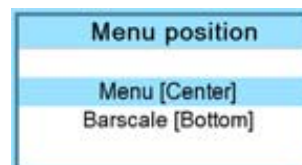

Image 13-70

13.8.2 Bar scale

What is possible?

The bar scale can be positioned on 3 different places on the screen but always vertically on the right side.

The horizontal position can be:

- Centered
- Top aligned
- Bottom aligned



Image 13-71
Bar scale position

How to change the position

1. Press **MENU** to activate the menus.
2. Use the **▲** or **▼** key to select *Projector control* and press **ENTER**.
3. Use the **▲** or **▼** key to select *Menu position* and press **ENTER**.
4. Use the **▲** or **▼** key to select *Menu* and press **ENTER** to toggle between [*Center*], [*Top*] and [*Bottom*].

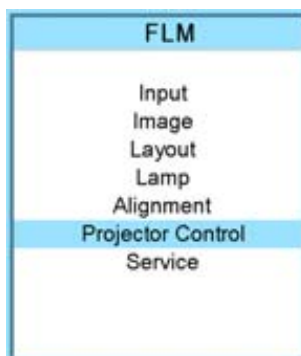

Image 13-72



Image 13-73

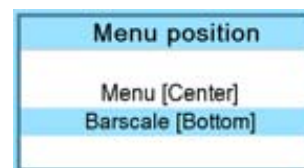

Image 13-74

13.9 Local LCD

Overview

- Local LCD time out
- Local LCD contrast

13.9.1 Local LCD time out

What can be done ?

The backlight time of the local LCD after a command is given can be set.

How to change

1. Press **MENU** to activate the menus.
2. Use the **▲** or **▼** key to select *Projector control* and press **ENTER**.
3. Use the **▲** or **▼** key to select *Local LCD* and press **ENTER**.
4. Use the **▲** or **▼** key to select *Local LCD time out* and press **ENTER** to toggle between [Off], [5sec], [10sec] and [15sec].

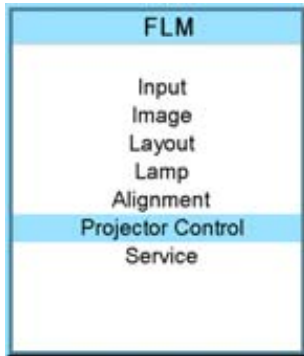

Image 13-75

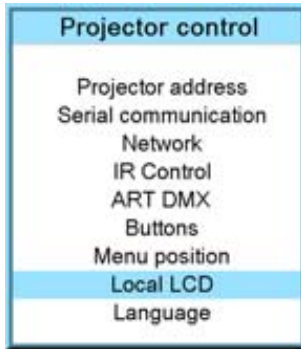

Image 13-76

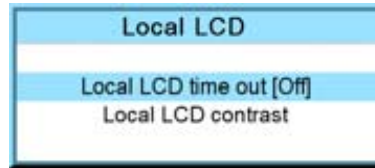

Image 13-77

13.9.2 Local LCD contrast

What is possible?

The contrast of the local LCD can be adapted the needs of the environment.

How to change?

1. Press **MENU** to activate the menus.
2. Use the **▲** or **▼** key to select *Projector control* and press **ENTER**.
3. Use the **▲** or **▼** key to select *Local LCD* and press **ENTER**.
4. Use the **▲** or **▼** key to select *Local LCD contrast* and press **ENTER**.
5. Use the **▲** or **▼** key to adjust the local contrast.

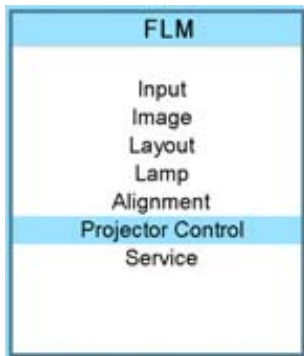

Image 13-78

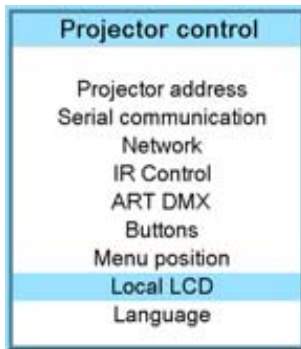

Image 13-79

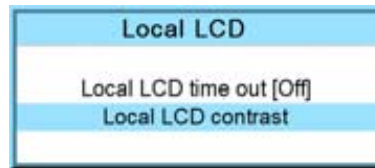

Image 13-80

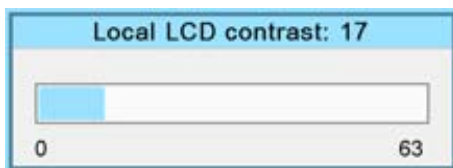

Image 13-81

13.10 Language selection

What can be done?

The user can change the language of the on screen menus and the local display menus to one of the available languages.

The following languages are available:

- English
- French
- German
- Spanish
- Italians

All available languages are indicated in the language of the country. The current active language is indicated by an asterisk (*).

How to change the language

1. Press **MENU** to activate the menus.
2. Use the **▲** or **▼** key to select *Projector control* and press **ENTER**.
3. Use the **▲** or **▼** key to select *Language* and press **ENTER**.
4. Use the **▲** or **▼** key to select the desired language. The change will take effect immediately.

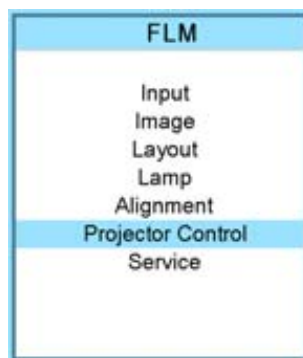

Image 13-82



Image 13-83



Image 13-84

14. SERVICE MENU

About this chapter

This chapter refers to the Service menu in which the customer can find valuable information when calling the Barco help desk.

Overview

- Overview flow
- Identification
- Diagnosis
- Convergence
- Internal service patterns
- Restore factory defaults
- Reset formatter
- Save custom settings
- Refill mode
- Broadcast mode
- USB memory

14.1 Overview flow

Overview

Level 1	Level 2	Level 3
Service		
	Identification	
	Diagnosis	Version Voltages Temperatures Fan speeds I2C SPI Error logging
	Convergence	
	Internal service patterns	PNP IN OSD PMP OUT FIB Formatter
	Restore factory defaults	
	Reset formatter	
	Save custom settings	
	Refill mode	
	Broadcast mode	
	USB memory	

14.2 Identification

What can be seen on the identification screen?

The identification screen shows the general information about the projector.

The following items will be displayed:

- Projector address
- Type of projector
- Package
- Configuration
- Baud rate
- IP address
- MAC address
- Text
- Serial number of projector: this number can be useful when calling for technical assistance.
- Runtime
- Lamp runtime
- Customer ID

How to display the screen?

1. Press **MENU** to activate the menus.
2. Use the **▲** or **▼** key to select *Service* and press **ENTER**.
The service window opens.
3. Use the **▲** or **▼** key to select *Identification* and press **ENTER**.
The identification screen is displayed.

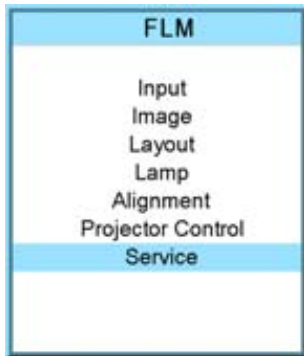

Image 14-1

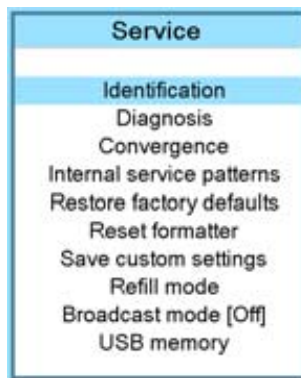

Image 14-2

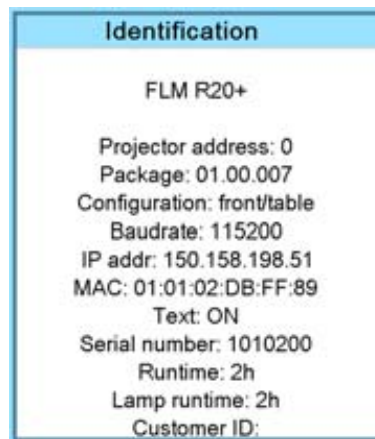

Image 14-3

Add a customer ID to identification window

When on the identification window:

1. Use the **▲** or **▼** key to select *Customer ID* and press **ENTER**.
The Customer ID input window opens.



Image 14-4

2. Use the **▲** or **▼** key to change the selected character.
Use the **◀** or **▶** key to selected another character.

Note: Digits can be entered with the digit keys on the remote control or on the local keypad. When a digit is entered in that way, the next character will be selected automatically.

14.3 Diagnosis

What can be seen?

The diagnosis menu gives the possibility to get an overview of the working of the projector.

14.3.1 How to start up the diagnosis?

Start up

1. Press **MENU** to activate the menus.
2. Use the **▲** or **▼** key to select *Service* and press **ENTER**.
The service window opens.
3. Use the **▲** or **▼** key to select *Diagnosis* and press **ENTER**.
The diagnosis screen will be displayed.

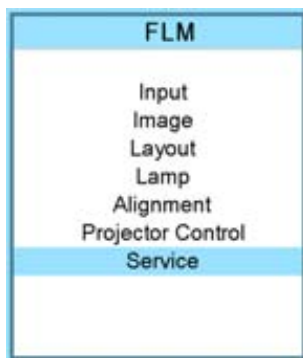

Image 14-5

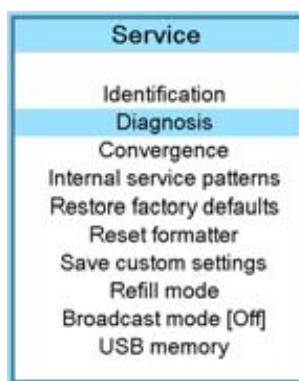

Image 14-6

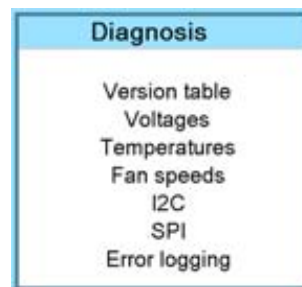

Image 14-7

Those menus who contain measured values, indicate also the limits if these are available.

14.3.2 Versions

How to display an overview?

1. Press **MENU** to activate the menus.
2. Use the **▲** or **▼** key to select *Service* and press **ENTER**.
The service window opens.
3. Use the **▲** or **▼** key to select *Diagnosis* and press **ENTER**.
The diagnosis screen is displayed.
4. Use the **▲** or **▼** key to select *Versions* and press **ENTER**.
The Versions overview is displayed.

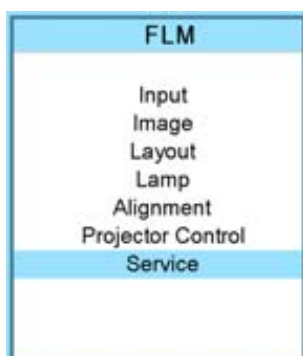

Image 14-8

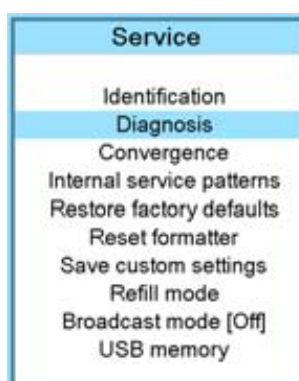

Image 14-9

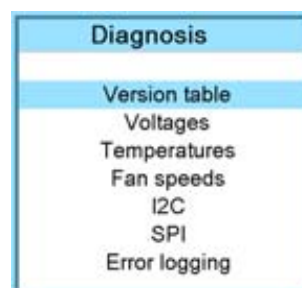

Image 14-10

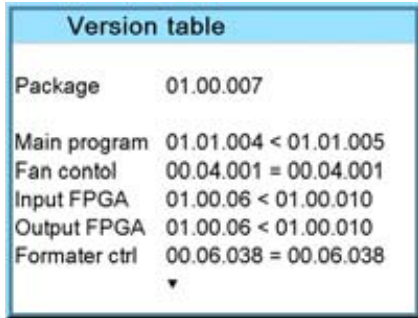

Image 14-11



Use the ▲ or ▼ item in the menu to select the previous or next page with information.

14.3.3 Voltages

How to display an overview?

1. Press **MENU** to activate the menus.
2. Use the ▲ or ▼ key to select *Service* and press **ENTER**.
The service window opens.
3. Use the ▲ or ▼ key to select *Diagnosis* and press **ENTER**.
The diagnosis screen will be displayed.
4. Use the ▲ or ▼ key to select *Voltages* and press **ENTER**.
The Voltage overview menu will be displayed.

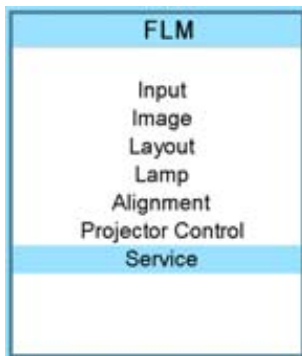

Image 14-12

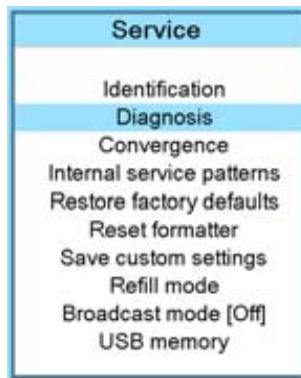

Image 14-13

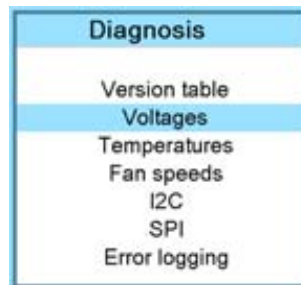

Image 14-14

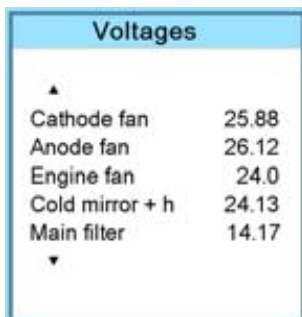

Image 14-15



Use the ▲ or ▼ item in the menu to select the previous or next page with information.

14.3.4 I²C diagnosis

How to select?

1. Press **MENU** to activate the menus.
2. Use the ▲ or ▼ key to select *Service* and press **ENTER**.
The service window opens.
3. Use the ▲ or ▼ key to select *Diagnosis* and press **ENTER**.
The diagnosis screen is displayed.
4. Use the ▲ or ▼ key to select *I2C* and press **ENTER**.
The I²C diagnosis overview is displayed.

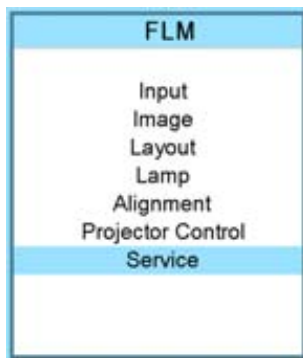

Image 14-16

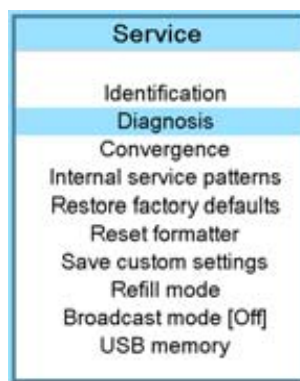

Image 14-17

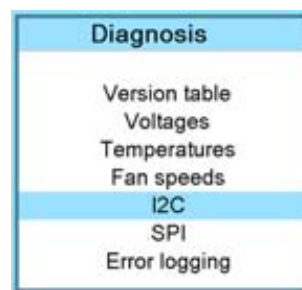

Image 14-18

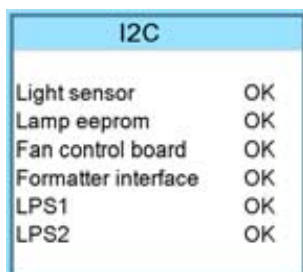

Image 14-19

14.3.5 Temperatures

How to get an overview?

1. Press **MENU** to activate the menus.
2. Use the ▲ or ▼ key to select *Service* and press **ENTER**.
The service window opens.
3. Use the ▲ or ▼ key to select *Diagnosis* and press **ENTER**.
The diagnosis screen will be displayed.
4. Use the ▲ or ▼ key to select *Temperatures* and press **ENTER**.

14. Service menu

The Temperature overview menu will be displayed.

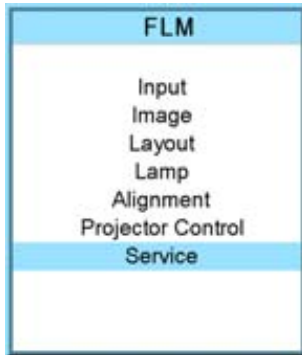

Image 14-20

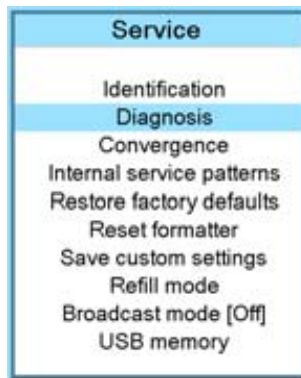

Image 14-21

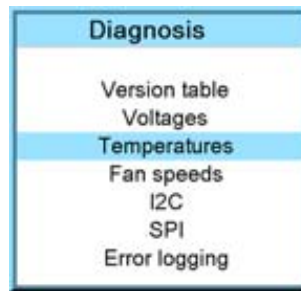

Image 14-22

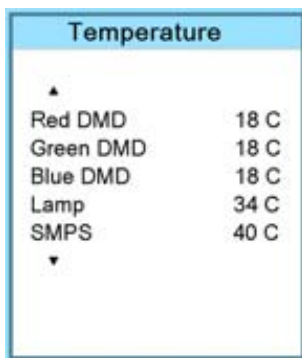

Image 14-23



Use the ▲ or ▼ item in the menu to select the previous or next page with information.

14.3.6 Fan speeds overview

How to get an overview?

1. Press **MENU** to activate the menus.
2. Use the ▲ or ▼ key to select *Service* and press **ENTER**.
The service window opens.
3. Use the ▲ or ▼ key to select *Diagnosis* and press **ENTER**.
The diagnosis screen will be displayed.
4. Use the ▲ or ▼ key to select *Fan speeds* and press **ENTER**.
The Fan speeds overview menu will be displayed.

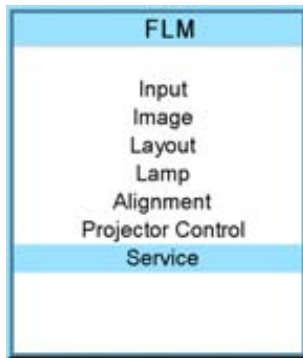

Image 14-24

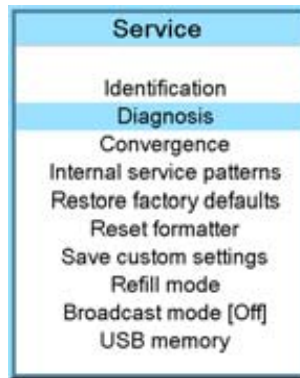

Image 14-25

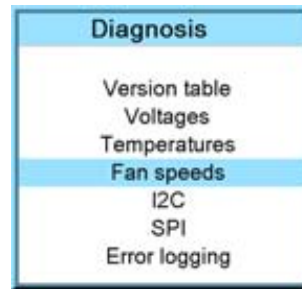

Image 14-26

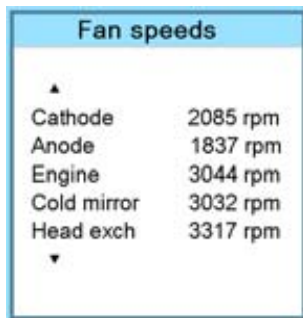

Image 14-27



Use the ▲ or ▼ item in the menu to select the previous or next page with information.

14.3.7 SPI

How to get an overview

1. Press **MENU** to activate the menus.
2. Use the ▲ or ▼ key to select *Service* and press **ENTER**.
The service window opens.
3. Use the ▲ or ▼ key to select *Diagnosis* and press **ENTER**.
The diagnosis screen will be displayed.
4. Use the ▲ or ▼ key to select *SPI* and press **ENTER**.
The SPI overview menu will be displayed.

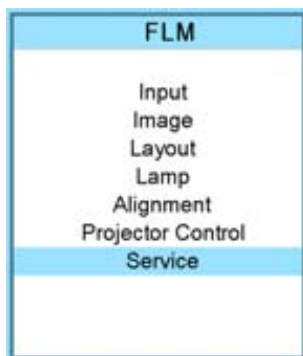

Image 14-28

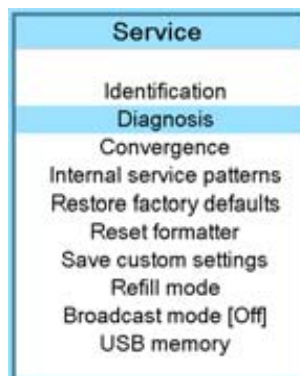

Image 14-29

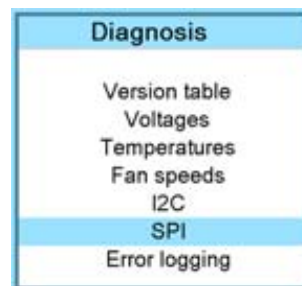

Image 14-30

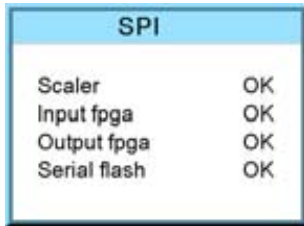

Image 14-31

14.3.8 Error logging overview

How to get an overview?

1. Press **MENU** to activate the menus.
2. Use the **▲** or **▼** key to select *Service* and press **ENTER**.
The service window opens.
3. Use the **▲** or **▼** key to select *Diagnosis* and press **ENTER**.
The diagnosis screen will be displayed.
4. Use the **▲** or **▼** key to select *Error logging* and press **ENTER**.
The Error logging overview menu is displayed.

For more explanation about the stored error message, see chapter "21. Troubleshooting", "Error codes", page 213.

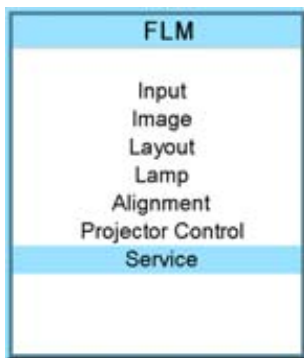

Image 14-32

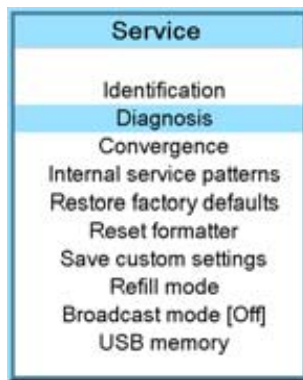

Image 14-33

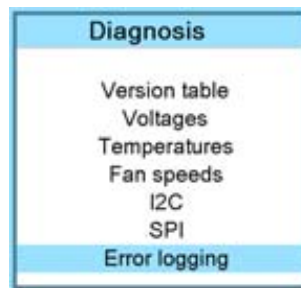

Image 14-34

14.4 Convergence

What can be done?

The convergence patterns can be used to check the convergence alignment of red, green and blue. If there is a misalignment of at least one 1 pixel, an electronic realignment is possible.

Mechanical realignment of the convergence can only be done by a qualified service technician.

How to display the convergence patterns and how to adjust

1. Press **MENU** to activate the menus.
2. Use the **▲** or **▼** key to select *Service* and press **ENTER**.
The service window opens.
3. Use the **▲** or **▼** key to select *Convergence* and press **ENTER**.
4. Use the **▲** or **▼** key to select the desired pattern and press **ENTER**.

The convergence pattern is displayed. Press **ENTER** to toggle to another pattern. Press **EXIT** to return to the menu.

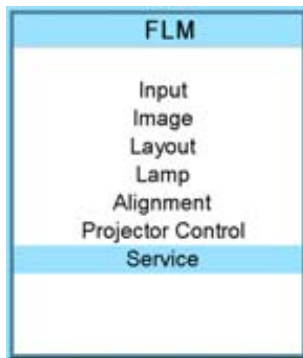

Image 14-35

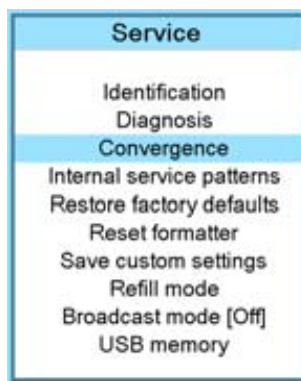

Image 14-36



Image 14-37

5. To adjust the convergence of the selected pattern, use the ◀ or ▶ for a horizontal adjustment and ▲ or ▼ for a vertical adjustment.



Image 14-38

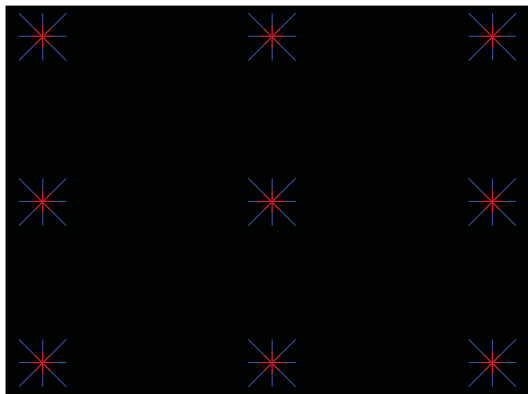
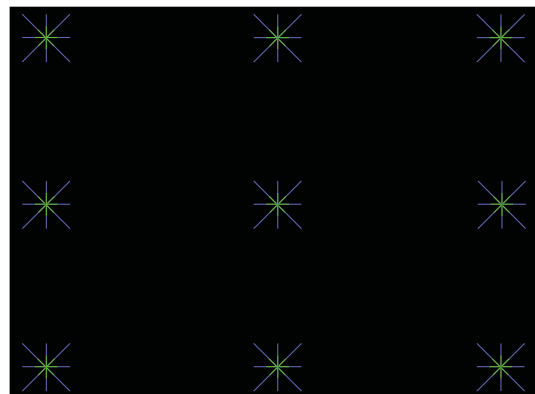

Image 14-39



Adjust until the crossing of the center Green (Red) convergence pattern coincide with the diagonal line of the center Blue convergence pattern.

14.5 Internal service patterns

How to select

1. Press **MENU** to activate the menus.
2. Use the ▲ or ▼ key to select *Service* and press **ENTER**.
The service window opens.
3. Use the ▲ or ▼ key to select *Internal service patterns* and press **ENTER**.

The internal service pattern window opens.

- Use the ▲ or ▼ key to select the desired patterns and press **ENTER**.

When a pattern is selected, press **ENTER** to toggle to other patterns of the selected type. Press **EXIT** to return to the internal service pattern menu.

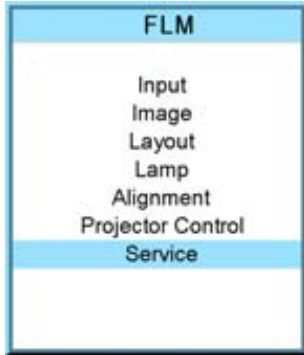

Image 14-40

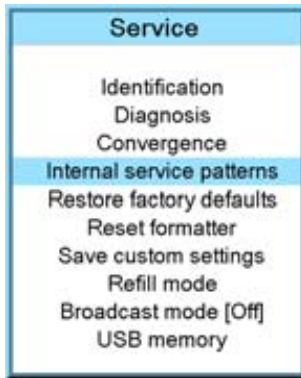

Image 14-41

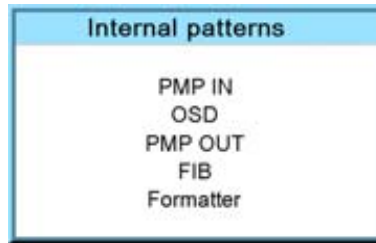

Image 14-42

14.6 Restore factory defaults

What can be done?

All settings of the projector will be set to the original factory settings with the exception of :

- IP address
- Serial settings
- DMX settings
- Electronic convergence

For these settings the choice exists to exclude them in the reset operation. .

With this operation, all user settings with the exception of the above mentioned are erased.

How to make an exception

- Press **MENU** to activate the menus.
- Use the ▲ or ▼ key to select *Service* and press **ENTER**.
The service window opens.
- Use the ▲ or ▼ key to select *Restore factory defaults* and press **ENTER**.
The factory defaults confirmation window opens.
- Use the ▲ or ▼ key to select the setting to exclude and press **ENTER** to toggle between [No] and [Yes].
Repeat this step if necessary for the other settings.

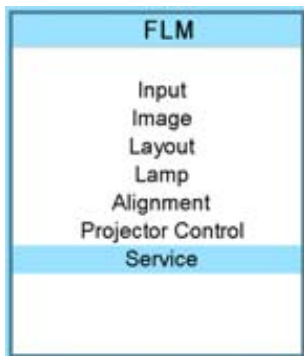

Image 14-43

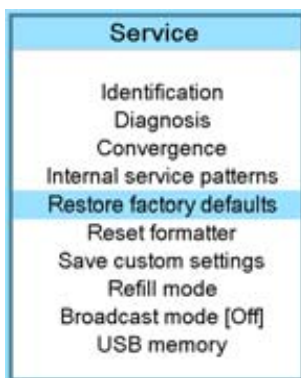

Image 14-44

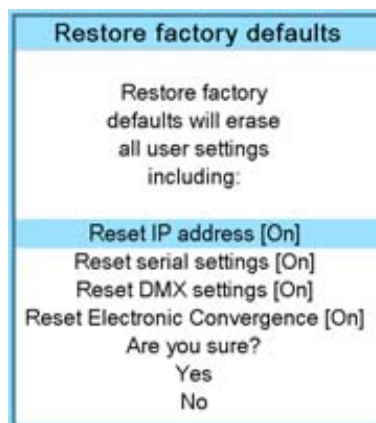

Image 14-45

How to return to the default settings

1. Press **MENU** to activate the menus.
2. Use the **▲** or **▼** key to select *Service* and press **ENTER**.
The service window opens.
3. Use the **▲** or **▼** key to select *Restore factory defaults* and press **ENTER**.
The factory defaults confirmation window opens.
4. Use the **▲** or **▼** key to select *Yes* or *No* and press **ENTER**.
If you are sure to restore the factory defaults and to erase the custom settings, select *Yes*.
If you are not sure, select *No*.

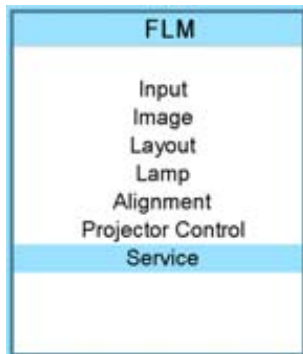

Image 14-46

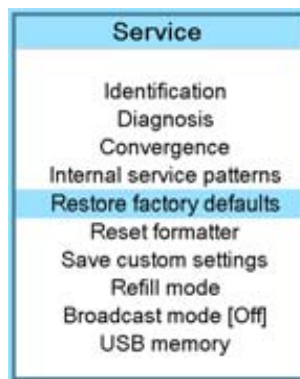

Image 14-47

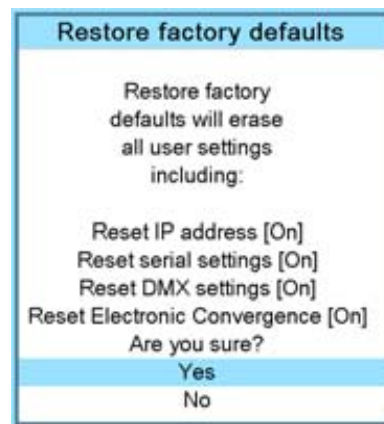

Image 14-48

14.7 Reset formatter

How to reset

1. Press **MENU** to activate the menus.
2. Use the **▲** or **▼** key to select *Service* and press **ENTER**.
The service window opens.
3. Use the **▲** or **▼** key to select *Reset formatter* and press **ENTER**.
The formatter reset confirmation window opens.
4. Use the **▲** or **▼** key to select *Yes* or *No* and press **ENTER**.
If you want to reset the formatter, select *Yes*.
If you do not want to reset the formatter, select *No*.

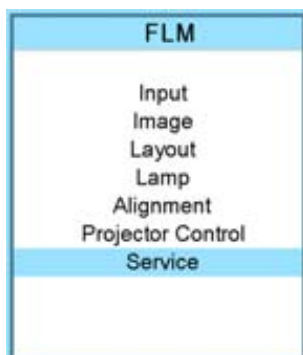

Image 14-49

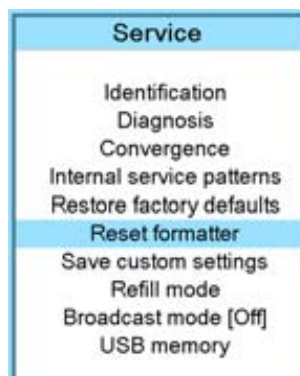

Image 14-50

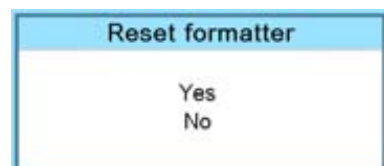

Image 14-51

14.8 Save custom settings

What is done?

The current custom settings can be saved to the internal backup device in the same way as it would be done when the projector was switched to standby.

How to save

1. Press **MENU** to activate the menus.
2. Use the ▲ or ▼ key to select *Service* and press **ENTER**.
The service window opens.
3. Use the ▲ or ▼ key to select *Save custom settings* and press **ENTER**.

The custom settings are written to the internal backup device. A message menu "Save data ..." is displayed during the save operation.

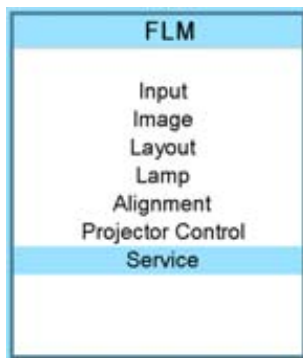

Image 14-52

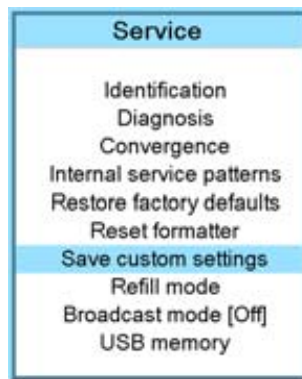

Image 14-53

14.9 Refill mode



Before selecting Refill mode, take first all preparations necessary to refill the cooling circuit.

What can be done?

When all preparations are taken, the refill mode will automatically activate the refill process.

How to start the refill mode

1. Press **MENU** to activate the menus.
2. Use the ▲ or ▼ key to select *Service* and press **ENTER**.
The service window opens.
3. Use the ▲ or ▼ key to select *Refill mode* and press **ENTER**.
A refill confirmation message is displayed.
4. Use the ▲ or ▼ key to select *Yes or No* and press **ENTER**.

Yes will switch the projector in refill mode.

When No is selected, the projector stays in normal mode.

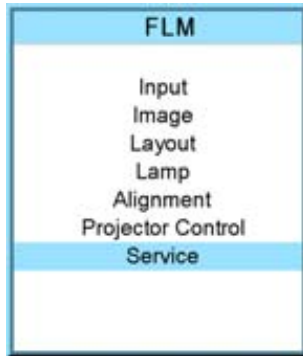

Image 14-54

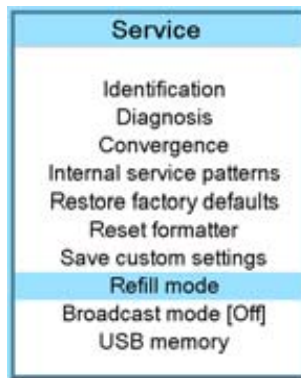

Image 14-55

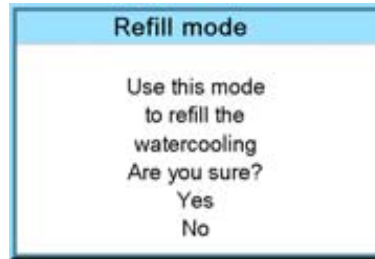

Image 14-56



CAUTION: Restart of the projector is necessary to terminate the refill mode. Before restarting, switch off the projector and reinstall first the cooling circuit.

14.10 Broadcast mode



Only accessible for HD projectors

What can be done ?

"Broadcast mode" enables special sequences for the DMD's to support specific sources such as the Thompson Grass Valley World-cam. It shouldn't be used in any other circumstances as it would cause image flicker and dimmed images with normal sources.

Default position : [Off]

How to set up

1. Press **MENU** to activate the menus.
2. Use the **▲** or **▼** key to select *Service* and press **ENTER**.
The service window opens.
3. Use the **▲** or **▼** key to select *Broadcast mode* and press **ENTER** to toggle between [Off] and [On].

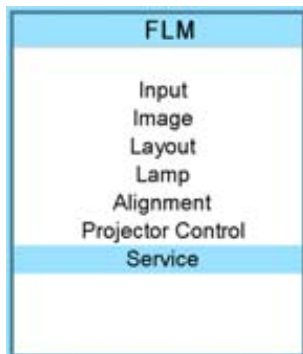

Image 14-57

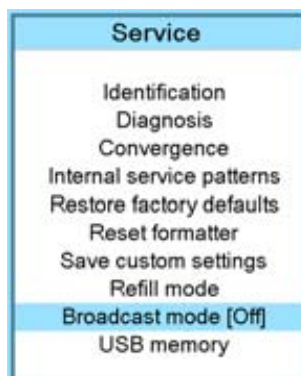

Image 14-58



When Broadcast mode ON, switch also Genlock to ON (*Input* → *Input locking* → *Automatic + Options*) and enter the correct values for this source.

14.11 USB memory

What is possible with an USB device?

An USB device, FAT 16 formatted can be used, to save custom settings from the projector or to load custom settings to the projector. This function is very handy to clone projectors.

The following settings can be transported via an USB device:

- baudrate
- address
- common address
- orientation
- text on/off
- file load mode
- eco mode & dimming
- rs232 interface & rs232 termination
- no signal setup settings
- IR receiver settings
- native resolution
- min delay
- current language of on screen menus
- customer id
- Network settings (DHCP, IP address, net mask, gateway address)
- blanking & keystone
- ScenergiX
- gamma
- color standard
- source switching
- effect settings
- broadcast mode
- menu position
- button settings
- locking settings

Saving custom settings

1. Connect a FAT 16 formatted USB device to the USB port.
2. Press **MENU** to activate the menus.
3. Use the **▲** or **▼** key to select *Service* and press **ENTER**.
The service window opens.
4. Use the **▲** or **▼** key to select *USB memory* and press **ENTER**.
5. Use the **▲** or **▼** key to select *Save custom settings* and press **ENTER**.

The custom settings on the projector are stored on the USB device together with the serial number of the projector. Different saves can be made from different projectors on the same USB device.

When there is no USB device connected to the USB slot, a message, *No USB device found*, is displayed.

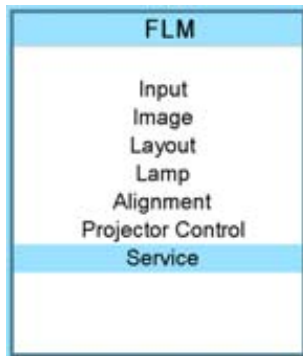

Image 14-59

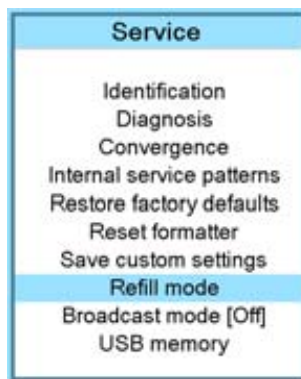

Image 14-60

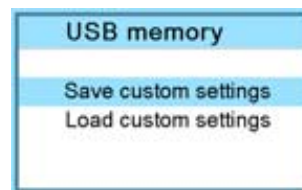

Image 14-61

Load custom settings

1. Connect a FAT 16 formatted USB device to the USB port.
2. Press **MENU** to activate the menus.
3. Use the **▲** or **▼** key to select *Service* and press **ENTER**.

The service window opens.

4. Use the **▲** or **▼** key to select *USB memory* and press **ENTER**.
5. Use the **▲** or **▼** key to select *Load custom settings* and press **ENTER**.

An list of serial numbers is given.

6. Use the **▲** or **▼** key to select the serial number to start from to load the settings.

The settings from the selected projector on the USB device are loaded into the current attached projector. The current projector settings are overwritten with these settings.

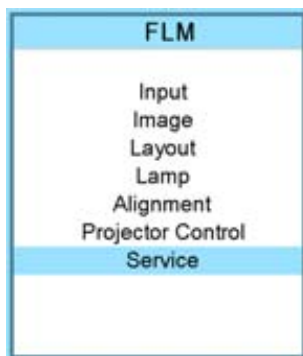

Image 14-62

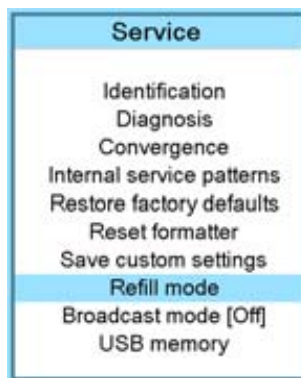

Image 14-63

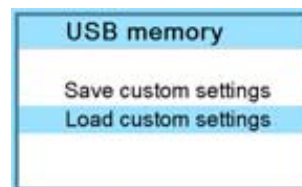

Image 14-64

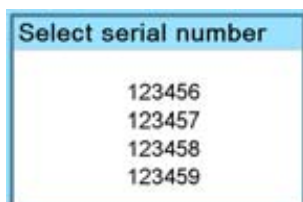

Image 14-65

15. MAINTENANCE

About this chapter

This chapter contains detailed maintenance procedures like dust filter replacement, lens cleaning etc. These procedures can easily be performed by the operator of the projector.



CAUTION: All HEPA filters of the projector must be replaced on a regular basis, depending on the environment conditions of the projector.



CAUTION: The pressure of the Liquid Cooling Circuit should be checked regularly. This pressure, indicated on the internal manometer, should be between 0,5 and 1 bar. If not, corrective action should be taken by qualified technical service personnel.



HEPA
High Efficiency Particulate Absorbing

Overview

- Replacement of the dust filter on the front side
- Replacement of the dust filter on the bottom side
- Replacement of the dust filter on the top side
- Pressure verification of the liquid cooling circuit
- Cleaning the lens
- Cleaning the exterior of the projector

15.1 Replacement of the dust filter on the front side

Necessary parts

New HEPA dust filter for the front side (R9854470).

How to replace the HEPA dust filter on the front side of the projector ?

1. Remove the front cover of the projector, see "Removal of the front cover", page 193.
2. Remove the HEPA dust filter on the front side by pulling the two spring clamps away from the filter and then moving the filter forwards.

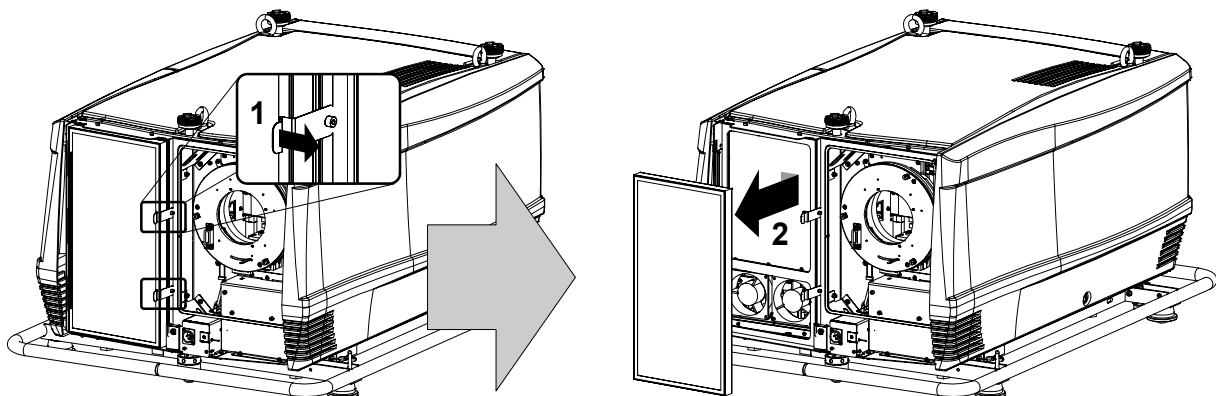

Image 15-1

3. Insert a new HEPA¹ filter by pulling the two spring clamps away and move the filter into position.
Caution: Make sure that the airflow indicated on the dust filter match with the airflow of the fans.
4. Reinstall the front cover of the projector, see "Installation of the front cover", page 196.

1. High Efficiency Particulate Arrestant



CAUTION: Never install a used HEPA filter. Always install a new HEPA filter.

15.2 Replacement of the dust filter on the bottom side

Necessary parts

- New HEPA dust filter for the bottom side (R9854480).
- 2.5 mm Allen key.

How to replace the HEPA dust filter on the bottom side of the projector ?

1. Remove the side cover of the projector, see "Removal of the side cover", page 194.
2. Release (not remove) the two wedge lock screws (A) using a 2.5 mm Allen key as illustrated.

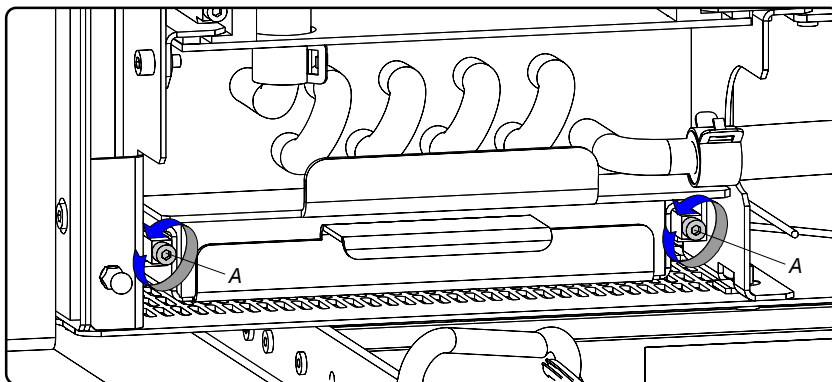

Image 15-2

3. Remove the filter (F) on the bottom side by pulling out the filter holder (H) as illustrated.

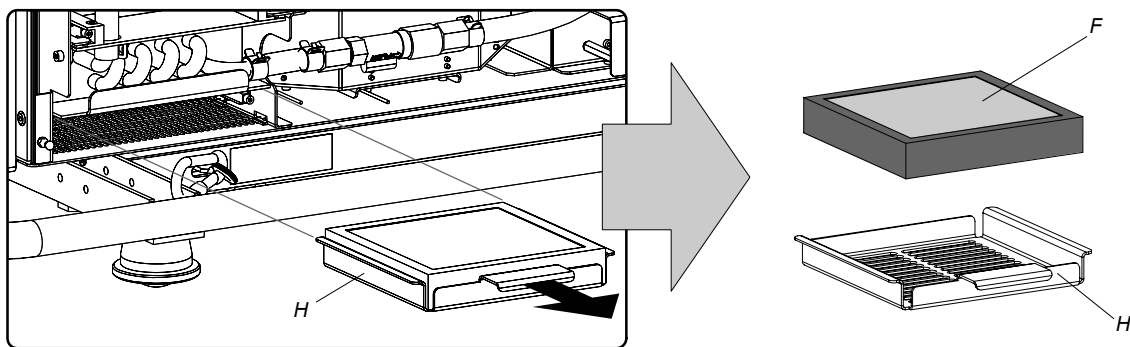

Image 15-3

4. Place a new HEPA dust filter in the filter holder.
Caution: Make sure that the airflow indicated on the dust filter match with the airflow of the fans.
5. Reinstall the filter holder containing the new HEPA filter.
6. Fasten the two wedge lock screws (A) using a 2.5 mm Allen key as illustrated.

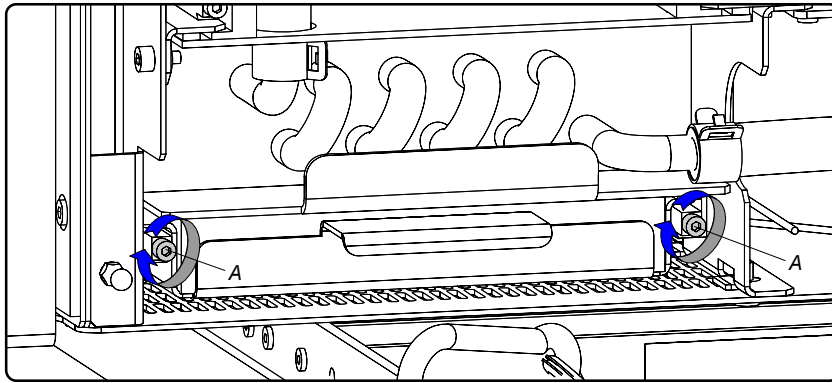

Image 15-4

7. Reinstall the side cover of the projector, see "Installation of the side cover", page 197.



CAUTION: Never install a used HEPA filter. Always install a new HEPA filter.

15.3 Replacement of the dust filter on the top side

Necessary parts

New HEPA dust filter for the top side (R9854480).

How to replace the HEPA dust filter on the top side of the projector ?

1. Remove the side cover of the projector, see "Removal of the side cover", page 194.
2. Remove the filter (F) on the top side by pulling out the filter holder (H) as illustrated.

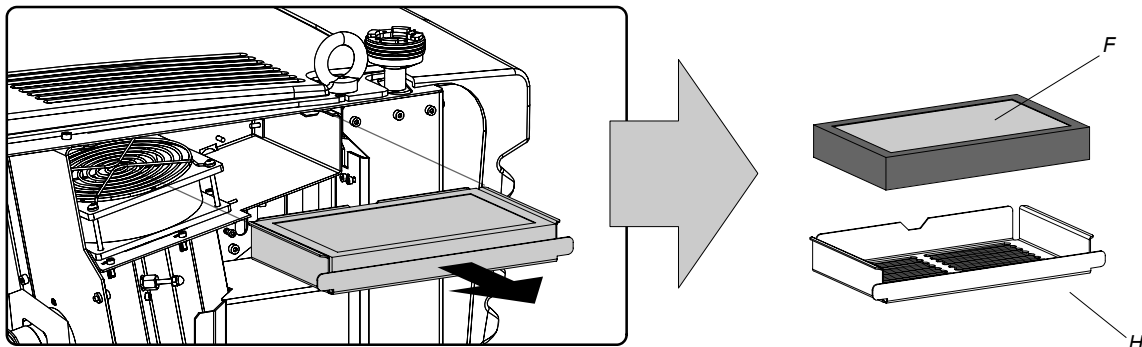

Image 15-5

3. Place a new HEPA dust filter in the filter holder.
Caution: Make sure that the airflow indicated on the dust filter match with the airflow of the fans.
4. Reinstall the filter holder containing the new HEPA filter.
5. Reinstall the side cover of the projector, see "Installation of the side cover", page 197.



CAUTION: Never install a used HEPA filter. Always install a new HEPA filter.

15.4 Pressure verification of the liquid cooling circuit

How to check the pressure of the liquid cooling circuit inside the projector ?

1. Remove the side cover of the projector, see "Removal of the side cover", page 194.

2. Check the pressure indicated on the internal manometer of the liquid cooling circuit.

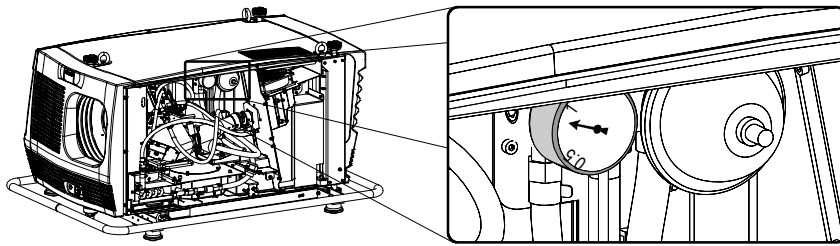

Image 15-6

3. This pressure should be between 0,5 and 1 bar. If the pressure, indicated on the manometer, is out of range, inform the responsible and qualified technicians, so they may take necessary corrective action.
4. Reinstall the side cover of the projector, see "Installation of the side cover", page 197.

15.5 Cleaning the lens



To minimize the possibility of damage to optical coatings, or scratches to lens surfaces, we have developed recommendations for cleaning. **FIRST**, we recommend you try to remove any material from the lens by blowing it off with clean, dry deionized air. **DO NOT** use any liquid to clean the lenses.

Necessary tools

Toraysee™ cloth (delivered together with the lens kit). Order number : R379058.

How to clean the lens ?

1. Always wipe lenses with a CLEAN Toraysee™ cloth.
2. Wipe lenses in a one single direction.
Warning: Do not wipe back and forwards across the lens surface as this tends to grind dirt into the coating.
3. Do not leave the cleaning cloth in either an open room or lab coat pocket, as doing so can contaminate the cloth.
4. If smears occur when cleaning lenses, replace the cloth. Smears are the first indication of a dirty cloth.



CAUTION: Do not use fabric softener when washing the cleaning cloth or softener sheets when drying the cloth.

Do not use liquid cleaners on the cloth as doing so will contaminate the cloth.



Other lenses can also be cleaned safely with this Toraysee™ cloth.

15.6 Cleaning the exterior of the projector

How to clean the exterior of the projector ?

1. Switch off the projector and unplug the power cord at the projector side.
2. Clean the housing of the projector with a damp cloth. Stubborn stains may be removed with a cloth lightly dampened with a mild detergent solution.

16. SERVICING

About this chapter

This chapter contains general servicing procedures like lamp replacement, input unit replacement etc. Note that some of these procedures may only be performed by qualified technical service personnel.

Overview

- Removal of the lamp house
- Removal of the input & communication unit
- Removal of an input module
- Installation of the lamp house
- Installation of the input & communication unit
- Installation of an input module
- Realignment of the lamp in its reflector

Extra service information

Extra service information for qualified service technicians can be found on Barco's Partnerzone (URL:www.partnerzone.events.barco.com). Registration is necessary.

If you are not yet registered, click on Partnerzone registration and follow the instructions. With the created login and password, it is possible to enter the partnerzone where you can find extra service information about the projector.

16.1 Removal of the lamp house



WARNING: This procedure may only be performed by qualified technical service personnel.



CAUTION: Never attempt to disassemble the lamp from its housing or to dispose of it. Return it to Barco. Due to its high internal pressure, the lamp may explode in either hot or cold states if improperly handled.

Necessary tools

7 mm flat screw driver.

How to remove the lamp house of the projector ?

1. Switch off the projector and unplug the power cord at the projector side.
2. Remove the lamp cover, see "Removal of the lamp cover", page 195.
3. Release the three spring lock screws of the lamp house as illustrated.

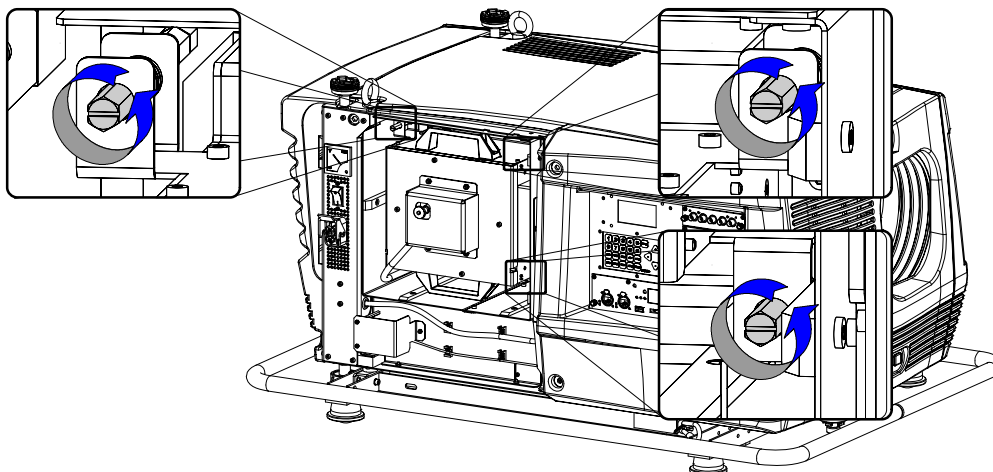

Image 16-1

4. Clasp the lamp house by the handles and pull the lamp house out of the projector.

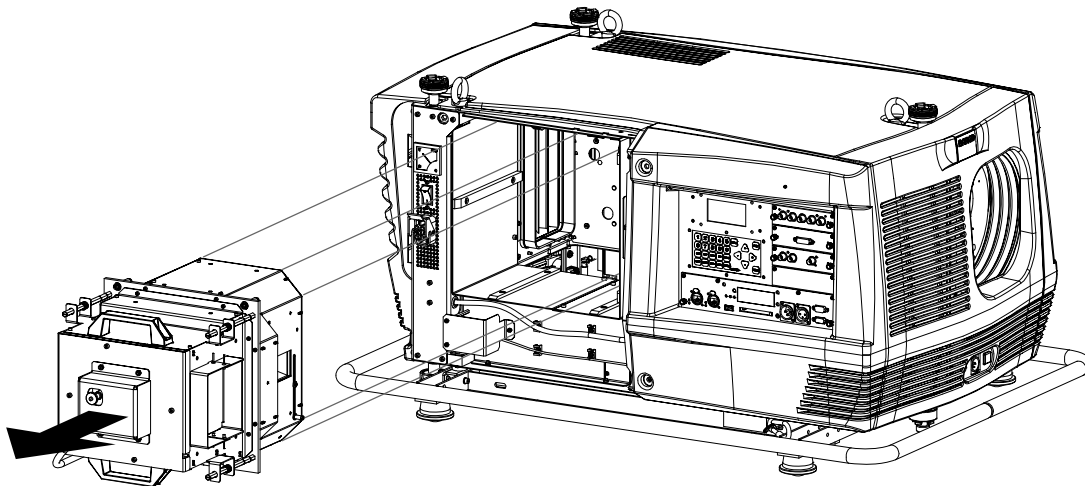

Image 16-2



While starting up the projector, the electronics detect if a lamp is installed. If no lamp is installed, it is not possible to start up the projector.

16.2 Removal of the input & communication unit



WARNING: This procedure may only be performed by qualified technical service personnel.

Necessary tools

7 mm flat screw driver.

How to remove the input & communication unit from the projector ?

1. Switch off the projector and unplug the power cord at the projector side. See procedure "Switching off", page 47.
2. Ensure that no cables are connected to one of the ports of the input & communication unit.
3. Remove the input cover, see "Removal of the input cover", page 195.
4. Release the four captive screws in the corners of the input and communication unit as illustrated.

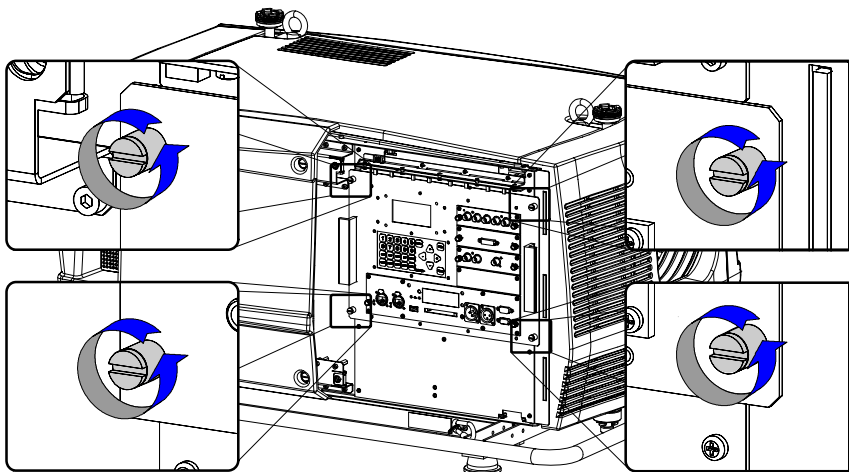

Image 16-3

5. Pull the input & communication unit out of its compartment, using the side handles provided.

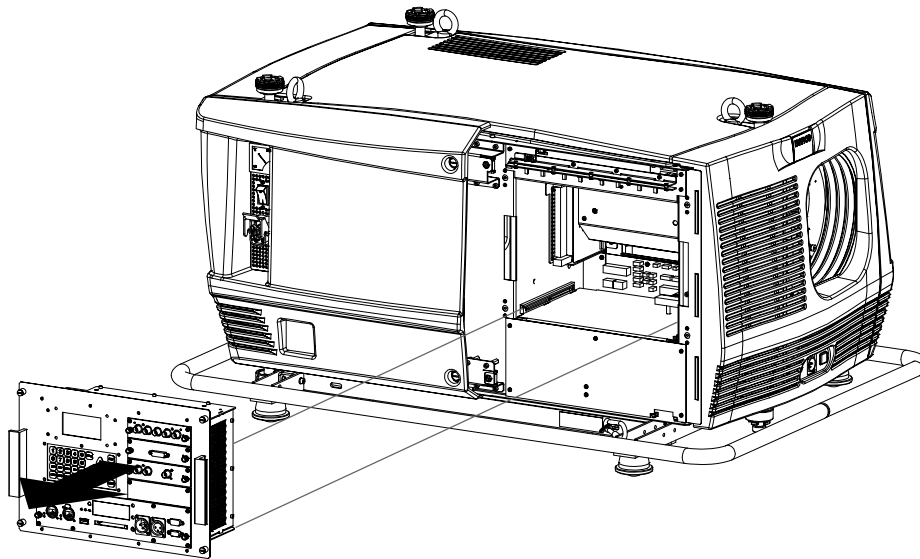

Image 16-4

16.3 Removal of an input module



The procedure below is applicable to all input modules of the input & communication unit of the projector.

Necessary tools

Phillips screw driver PH1.

How to remove an input module out of the input & communication unit of the projector ?

1. Switch off the projector and unplug the power cord at the projector side.
2. Release the two captive screws of the input module using a Phillips screw driver PH1.

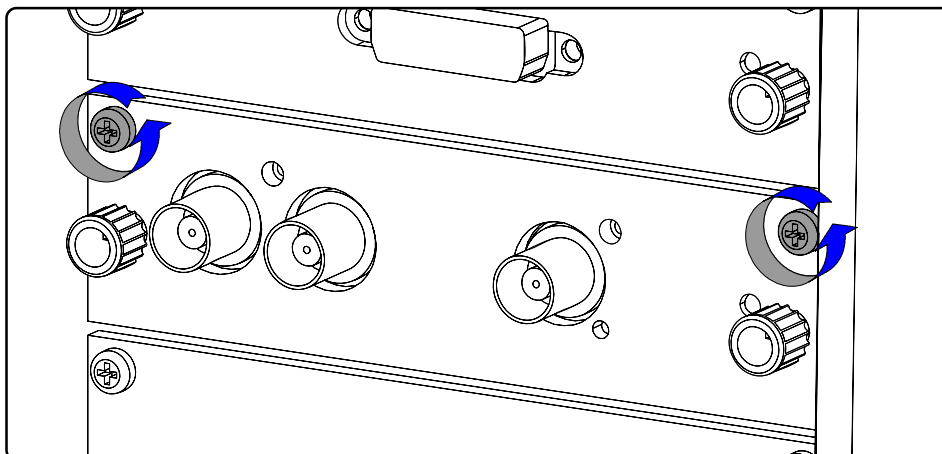

Image 16-5

3. Pull the input module out of the input & communication unit, via the two knobs provided.

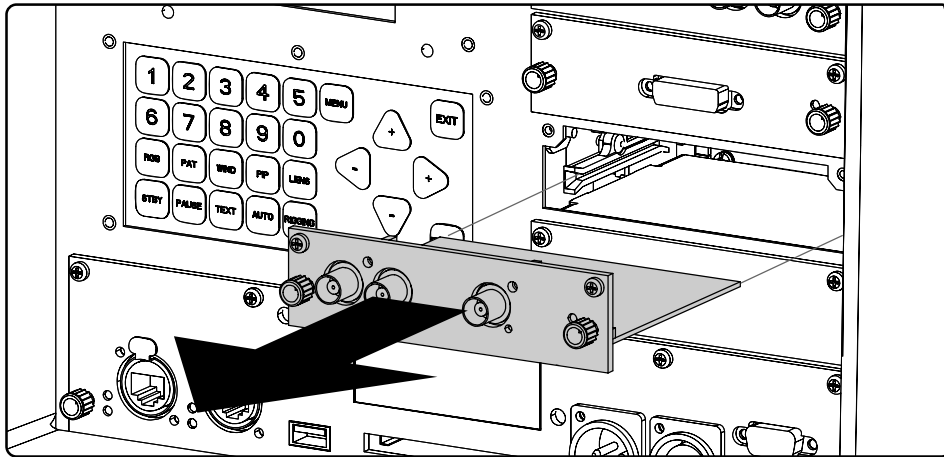

Image 16-6



CAUTION: Ensure that all unused input slots of the input & communication unit are always covered with a dummy front plate. After removing one of the input modules, immediately replace with an other one or install a dummy front cover on the unused input slot.

16.4 Installation of the lamp house



WARNING: This procedure may only be performed by qualified technical service personnel.



CAUTION: Never attempt to disassemble the lamp from its housing or to dispose of it. Return it to Barco. Due to its high internal pressure, the lamp may explode in either hot or cold states if improperly handled.

Necessary tools

7 mm flat screw driver.

How to install the lamp house of the projector ?

1. Ensure the projector is switched off and the power cord at the projector side is unplugged.
2. Remove the lamp cover, if not removed yet. See "Removal of the lamp cover", page 195.
3. Clasp the lamp house by its handles and gently slide the lamp house into its socket. Note that the compartment is provided with guides (G) to position the lamp house correctly.

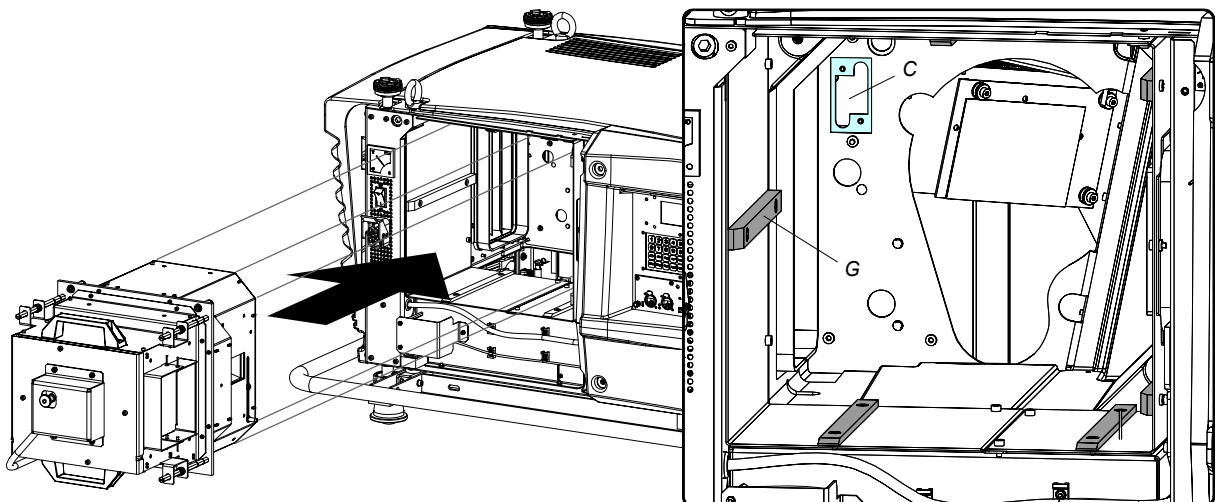

Image 16-7

4. Push the lamp house forward until it slides fully into the projector.
5. Secure the correct position of the lamp house by tightening all three spring lock screws as illustrated.

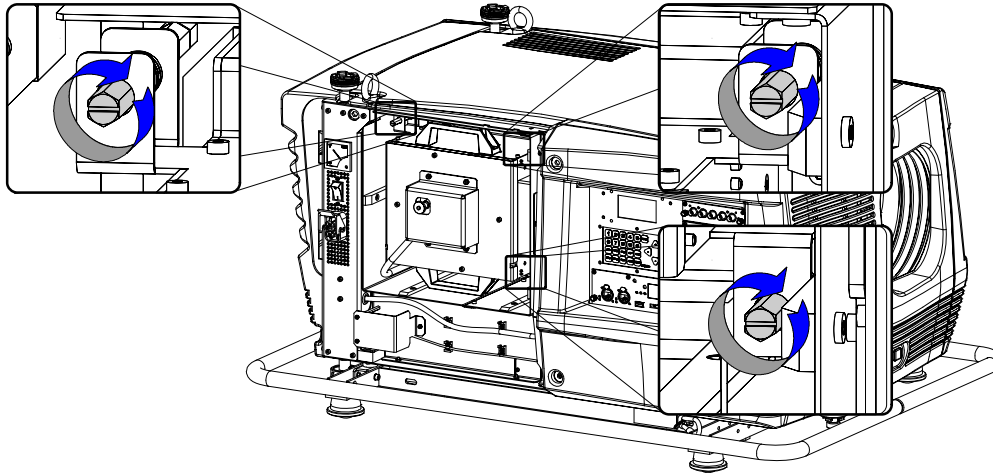

Image 16-8

6. Reinstall the lamp cover of the projector, see "Installation of the lamp cover", page 198.



While starting up the projector, the electronics detect if a lamp is installed. If no lamp is installed, it is not possible to start up the projector.

16.5 Installation of the input & communication unit



WARNING: This procedure may only be performed by qualified technical service personnel.

Necessary tools

7 mm flat screw driver.

How to install the input & communication unit of the projector ?

1. Ensure that the projector is switched off and the power cord at the projector side is unplugged.
2. Remove the input cover, if not removed yet. See "Removal of the input cover", page 195.
3. Hold the input & communication unit by its handles and gently slide the unit into the guides at the bottom of the input & communication socket inside the projector.

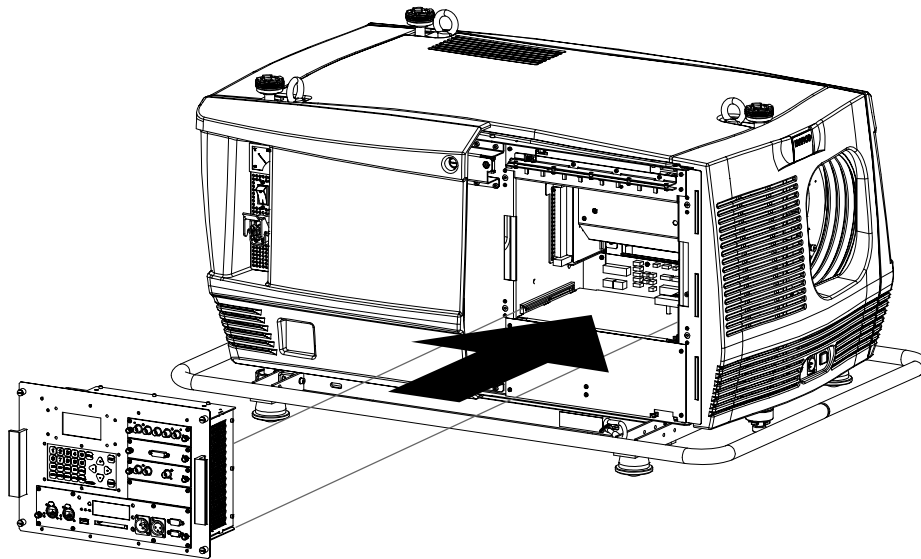

Image 16-9

4. Push the input & communication unit forward until you feel the connectors of the unit fit in their sockets. The back of the front plate of the unit must touch the chassis of the projector.
5. Secure the input & communication unit by fastening the four captive screws in the corners of the unit.

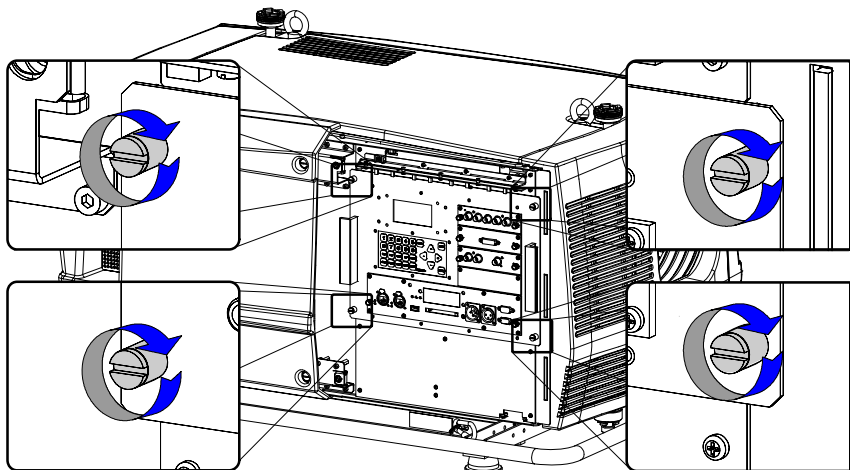

Image 16-10

16.6 Installation of an input module



The procedure below is applicable to all input modules of the input & communication unit of the projector.

Necessary tools

Phillips screw driver PH1.

How to install an input module into the input & communication unit of the projector ?

1. Switch off the projector and unplug the power cord at the projector side.
2. Slide the input module into the guides of the input slot.

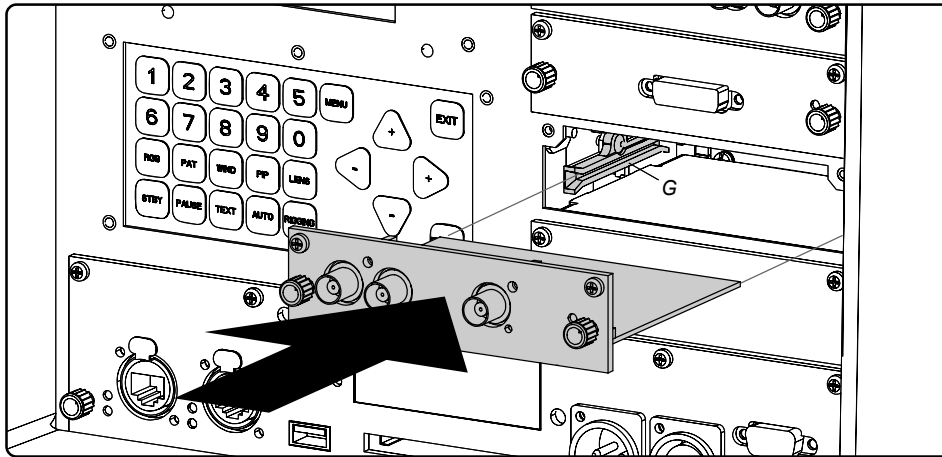

Image 16-11

3. Push the input module forward until you feel that the connector of the input module fit in the socket of the input slot. The back of the front plate of the module must touch the front plate of the input & communication unit.
4. Secure the input module by fastening both captive screws in the top corners of the module.

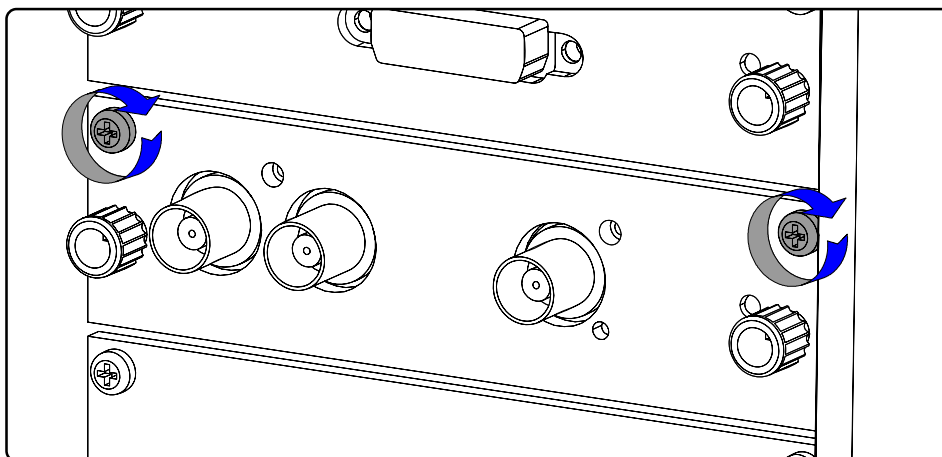

Image 16-12

16.7 Realignment of the lamp in its reflector

Why realigning the lamp ?

With longer run times, the light output of the lamp will decrease, which results in a lower light output on the screen. This light output decrease can be compensated by readjusting the Z-position of the lamp.



WARNING: This procedure may only be performed by qualified technical service personnel.

How to realign the lamp in its reflector ?

1. Remove the cover of the lamp, see "Removal of the lamp cover", page 195.
2. Connect the projector to the local power net, see "Power connection", page 35.
3. Start up the projector, enter the menu structure and select Lamp / Z-axis (for more explanation, see "Z-axis adjustment", page 115)
4. Carefully turn the thumb screw (A) at the rear of the lamp house clockwise for maximum light output. Once over the maximum, turn slightly counterclockwise to reach the maximum light output again.

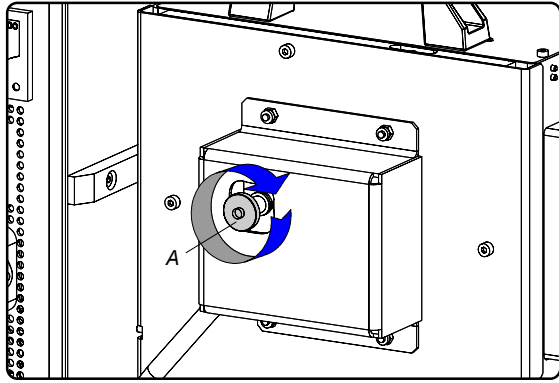

Image 16-13

5. Switch off the projector, wait five minutes and unplug the power cord at the projector side.
6. Reinstall the cover of the lamp, see "Installation of the lamp cover", page 198.

17. REMOVAL OF THE PROJECTOR COVERS

About this chapter

Most maintenance and servicing procedures demand removing one or more of the projector covers to gain access to the parts to maintain or to service. To avoid redundancy, all procedures about cover removing or installing are grouped together in this chapter. The maintenance and servicing procedures also refer to this chapter if required. The procedures in this chapter describe, with detailed step by step actions and illustrations, how to remove or install the projector covers. Note that some covers may only be removed by qualified service personnel, see remarks above each procedure.



WARNING: Always switch off the projector and unplug the power cord at the projector side before removing one of the covers.

Overview

- Removal of the front cover
- Removal of the side cover
- Removal of the lamp cover
- Removal of the input cover
- Installation of the front cover
- Installation of the side cover
- Installation of the lamp cover
- Installation of the input cover

17.1 Removal of the front cover

Necessary tools

7 mm flat screw driver.

How to remove the front cover of the projector ?

1. Remove the lens. See chapter "Lens removal", page 26.
2. Remove the rubber dust ring from the lens holder. See image 17-1.
3. Release the captive screw at the middle bottom of the front cover, using a flat screw driver.

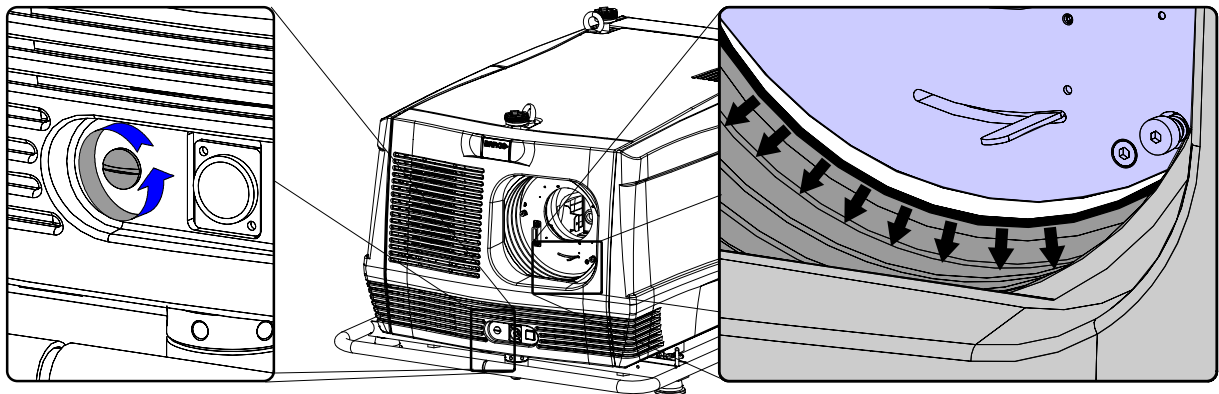

Image 17-1

4. Remove the front cover from the projector doing the following:
 - a) standing in front of the projector, pull the right side of the front cover toward you until the latches release (left side is hinged)
 - b) then slide the front cover to the right to release it from the hinging points.

17. Removal of the projector covers

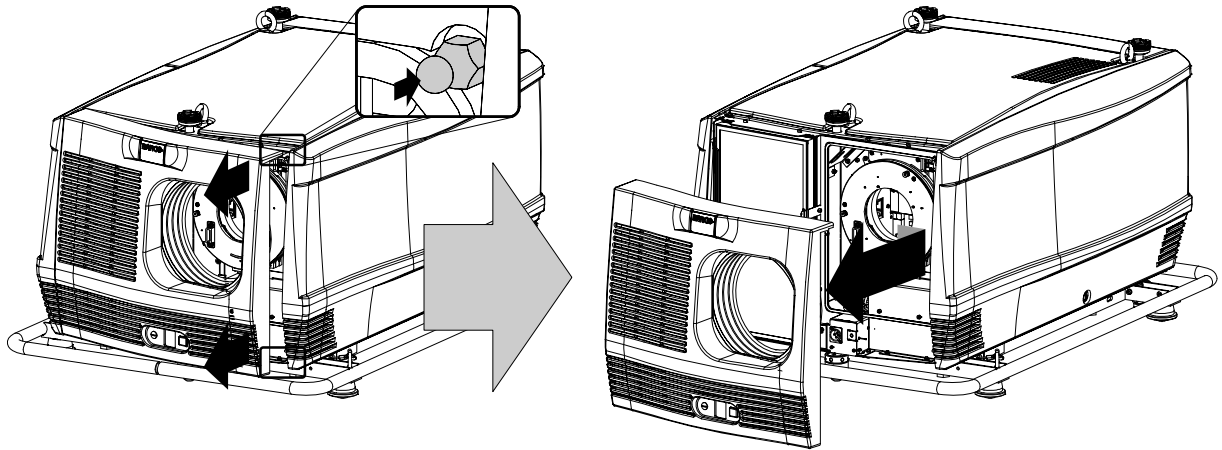

Image 17-2

17.2 Removal of the side cover



CAUTION: Remove the side cover of the projector only in a clean and dust free area. Never remove the side cover in an area which is subject to airborne contaminants such as that produced by smoke machines or similar.

Necessary tools

7 mm flat screw driver.

How to remove the side cover of the projector ?

1. Release the captive screw at the middle bottom of the side cover, using a flat screw driver.

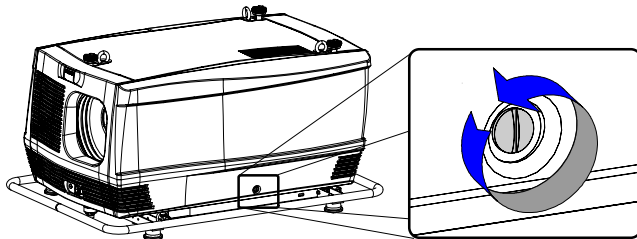

Image 17-3

2. Remove the side cover from the projector doing the following:
 - a) gently pull out the bottom corners (A) of the side cover,
 - b) then gently pull out the top corners (B) of the side cover,
 - c) then move the side cover away from the projector (C).

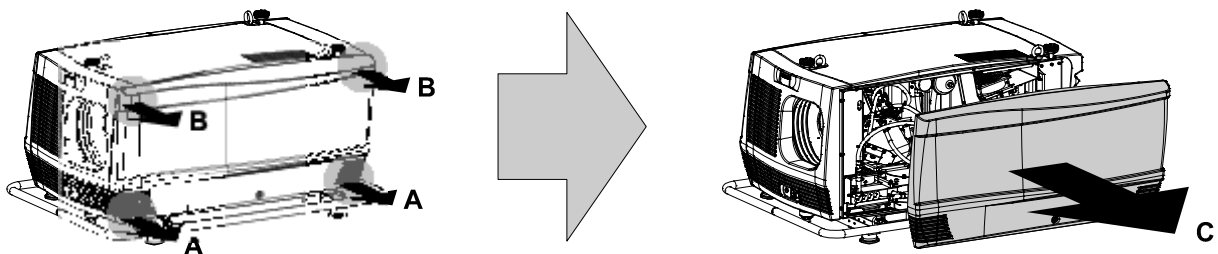

Image 17-4

17.3 Removal of the lamp cover



WARNING: This procedure may only be performed by qualified technical service personnel.

Necessary tools

7 mm flat screw driver.

How to remove the lamp cover of the projector ?

1. Release the two captive screws at the top and bottom right side of the lamp cover, using a flat screw driver.

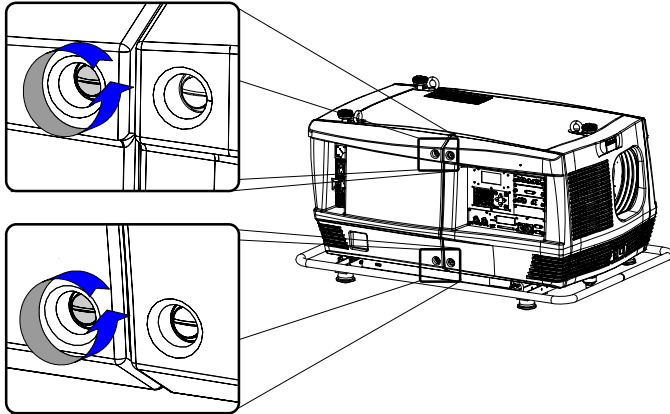

Image 17-5

2. Remove the lamp cover from the projector doing the following:
 - a) gently pull out the left bottom corner (A) of the lamp cover,
 - b) then gently pull out the left top corner (B) of the lamp cover,
 - c) then move the lamp cover away from the projector (C).

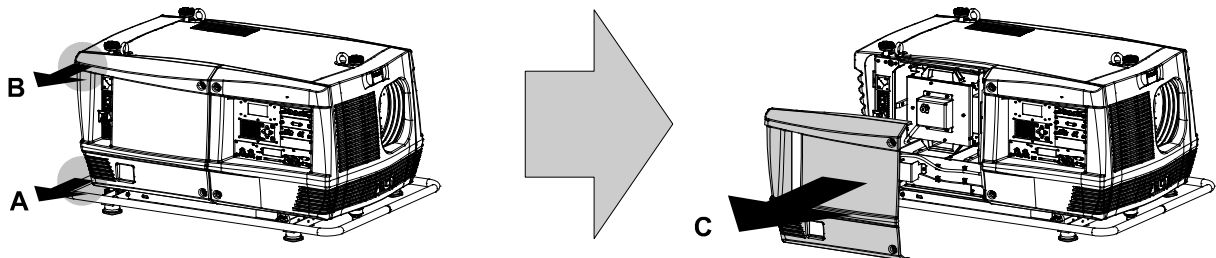

Image 17-6

17.4 Removal of the input cover



WARNING: This procedure may only be performed by qualified technical service personnel.

Necessary tools

7 mm flat screw driver.

How to remove the input cover of the projector ?

1. Release the two captive screws at the top and bottom left side of the input cover, using a flat screw driver.

17. Removal of the projector covers

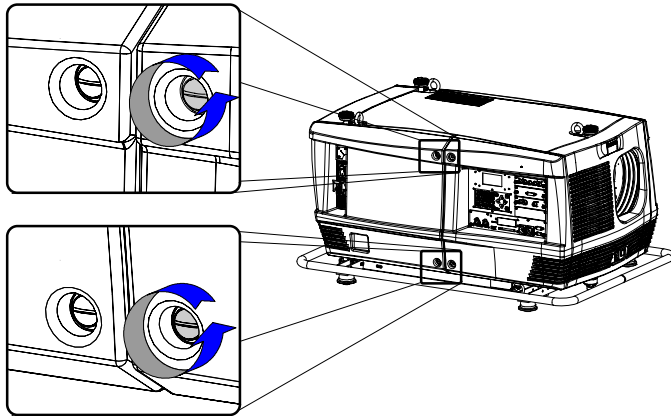

Image 17-7

2. Remove the input cover from the projector doing the following:
 - a) gently pull out the right bottom corner (A) of the input cover,
 - b) then gently pull out the right top corner (B) of the input cover,
 - c) then move the input cover away from the projector (C).

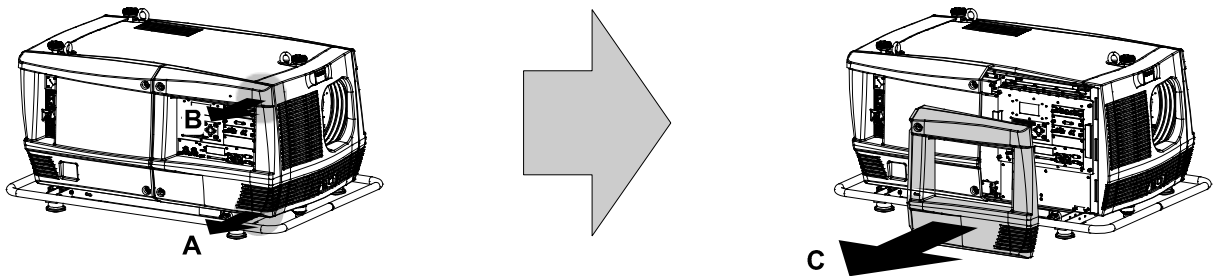

Image 17-8

17.5 Installation of the front cover

Necessary tools

7 mm flat screw driver.

How to install the front cover of the projector ?

1. Check if the front filter is present.
2. Ensure that no lens is mounted.
3. Install the front cover of the projector doing the following:
 - a) first hook in the side of the front cover at the front filter,
 - b) then gently push the other side of the front cover into position,
 - c) ensure that the locking studs in the corners click into their receivers.

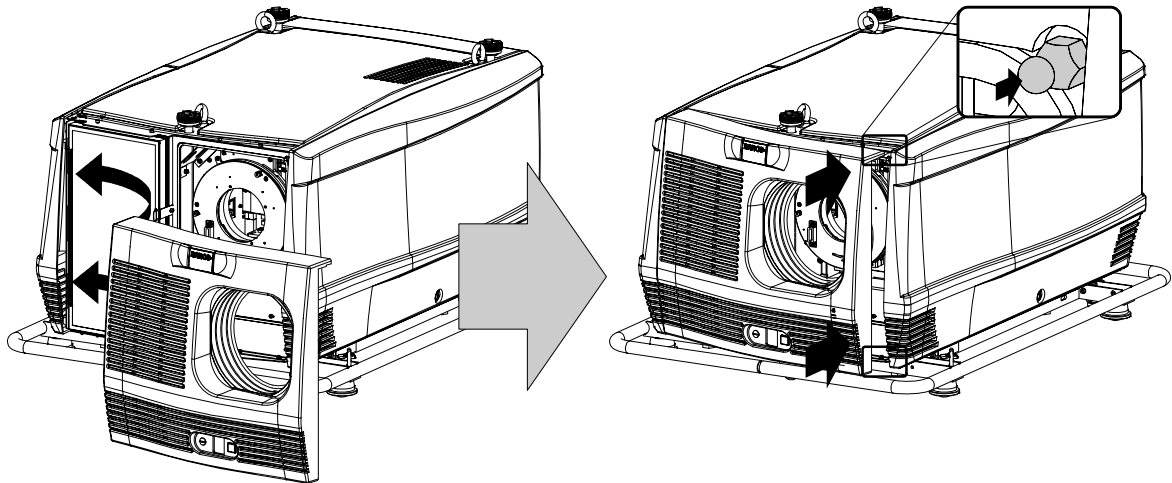

Image 17-9

4. Secure the front cover by locking the captive screw in the middle at the bottom of the front cover.

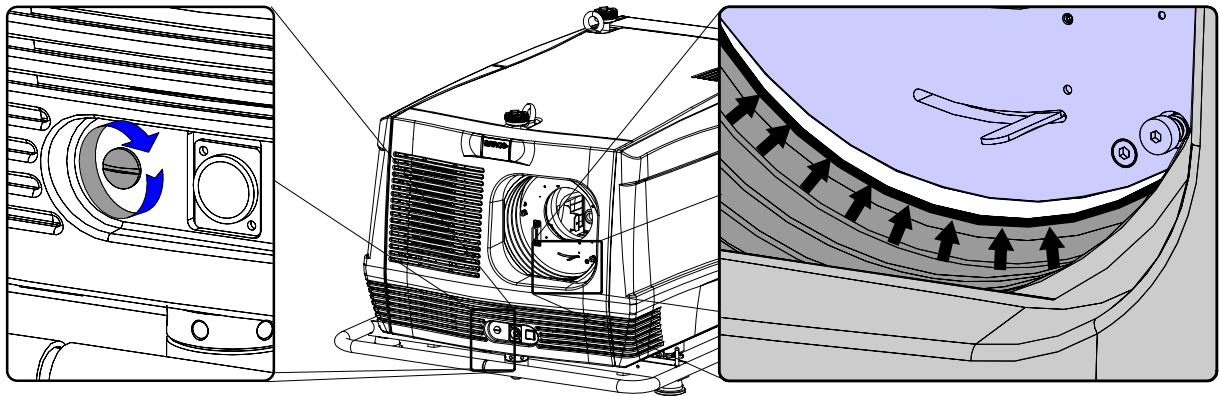

Image 17-10

5. Reinstall the rubber dust ring around the lens holder. See image 17-10.

17.6 Installation of the side cover

Necessary tools

7 mm flat screw driver.

How to install the side cover of the projector ?

1. Check if the bottom and top filters are present.
2. Check the pressure indicated on the internal manometer of the liquid cooling circuit. This pressure should be between 0,5 and 1 bar. If the pressure is out of range, inform the responsible and qualified technician, so he may take necessary corrective action.

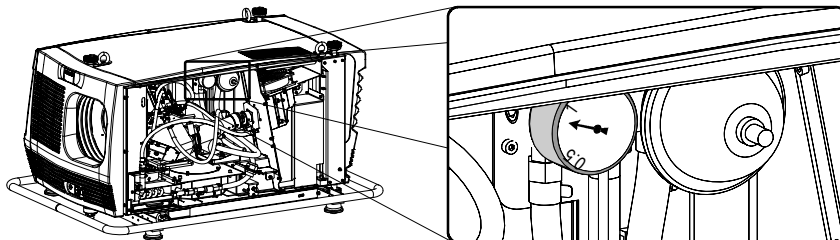

Image 17-11

3. Install the side cover of the projector doing the following:
 - a) Bring the side cover towards its final position (A),
 - b) then gently push the locking studs of the top corners (B) into their receivers,
 - c) then gently push the locking studs of the bottom corners (C) into their receivers.

17. Removal of the projector covers

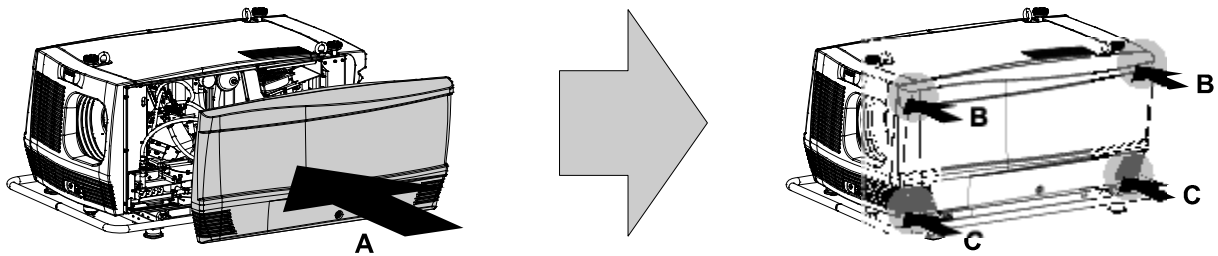

Image 17-12

4. Secure the side cover by locking the captive screw in the middle at the bottom of the side cover.

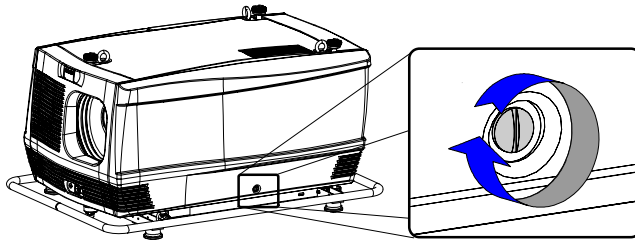

Image 17-13

17.7 Installation of the lamp cover

Necessary tools

7 mm flat screw driver.

How to install the lamp cover of the projector ?

1. Install the lamp cover of the projector doing the following:
 - a) Bring the lamp cover towards its final position (A),
 - b) then gently push the locking stud at the left top corner (B) into its receiver,
 - c) then gently push the locking stud at the left bottom corner (C) into its receiver.

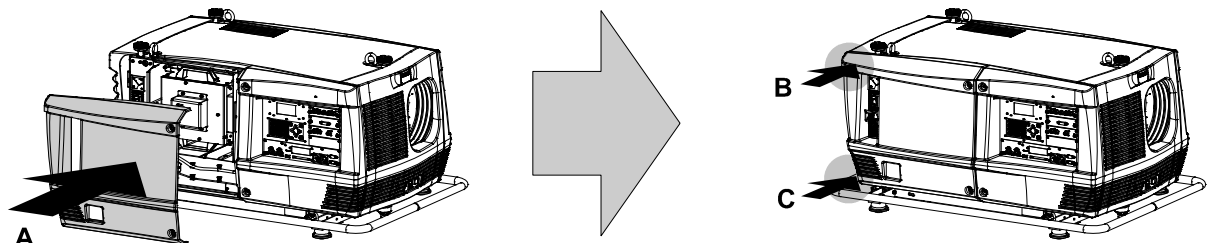

Image 17-14

2. Secure the lamp cover by locking the two captive screws at the right side of the lamp cover.

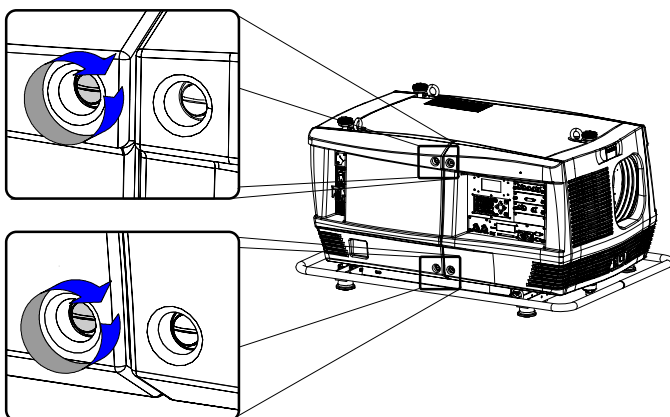

Image 17-15

17.8 Installation of the input cover

Necessary tools

7 mm flat screw driver.

How to install the input cover of the projector ?

1. Install the input cover of the projector doing the following:
 - a) Bring the input cover towards its final position (A),
 - b) then gently push the locking stud at the right top corner (B) into its receiver,
 - c) then gently push the locking stud at the right bottom corner (C) into its receiver.

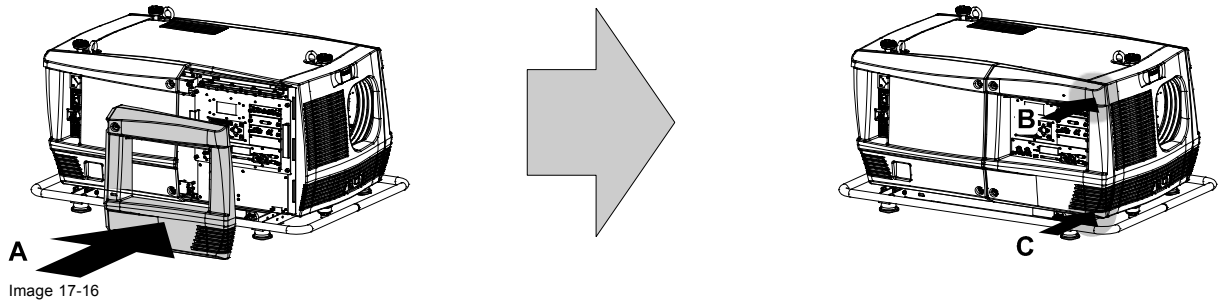

2. Secure the input cover by locking the two captive screws at the left side of the input cover.

18. DIMENSIONS

Overview

- Dimensions of the FLM R22+
- Dimensions of the FLM flight case
- Dimensions of the rigging clamps

18.1 Dimensions of the FLM R22+

Dimensions

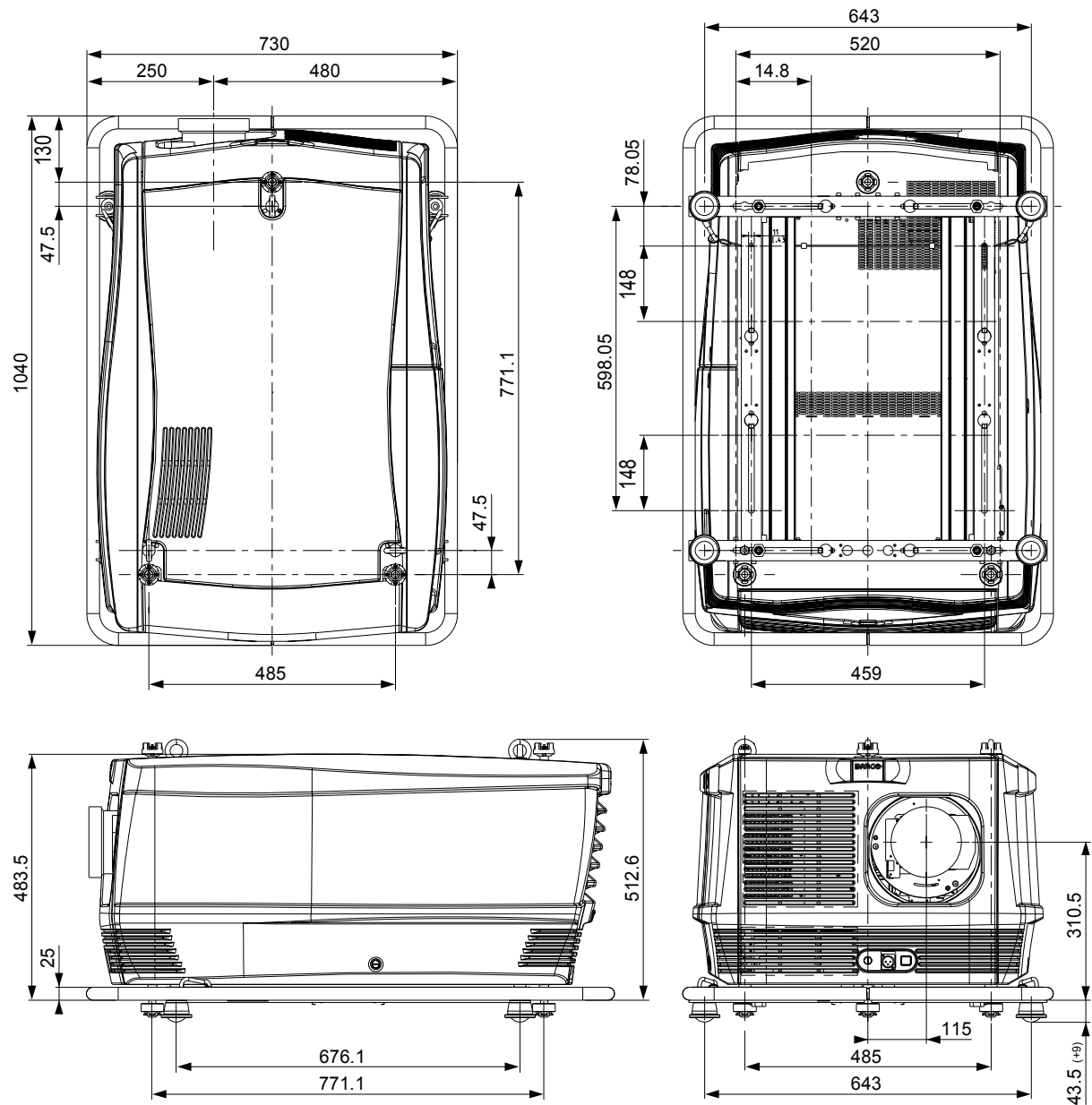

Image 18-1
Dimensions given in millimeters.

Point of gravity

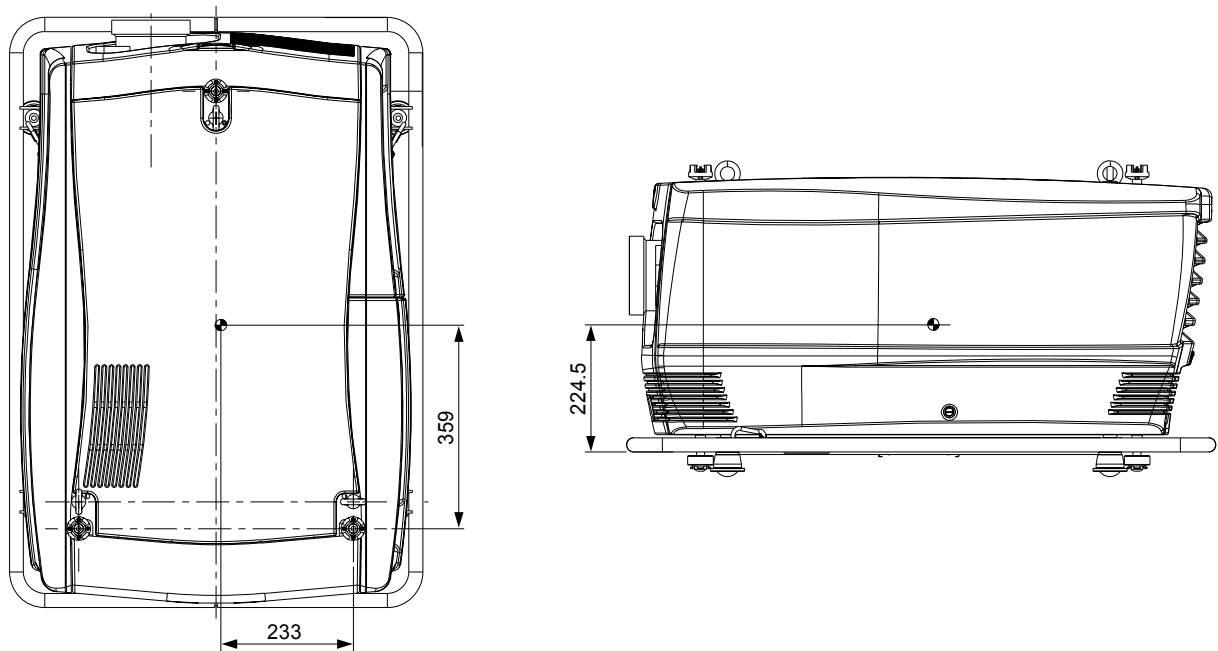

Image 18-2
Dimensions given in millimeters.

18.2 Dimensions of the FLM flight case

Dimensions

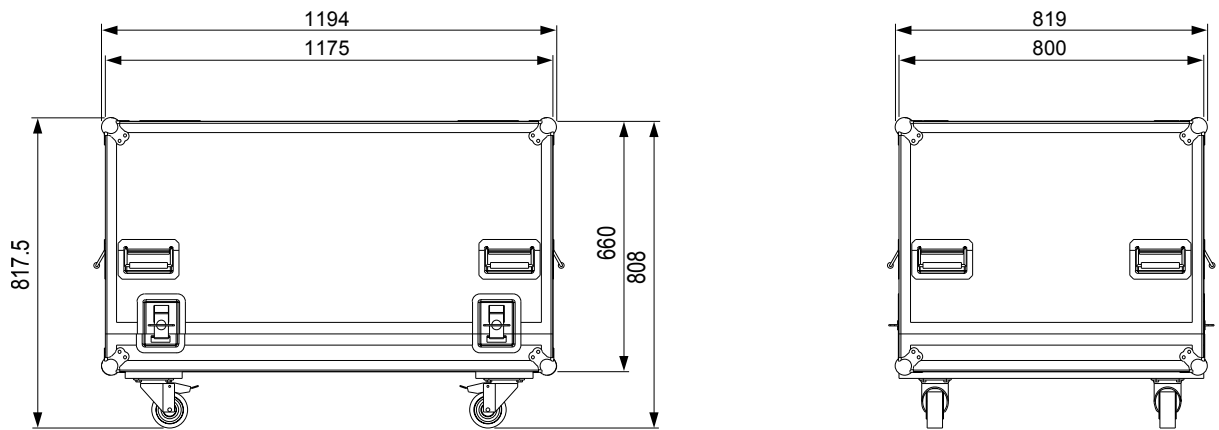

Image 18-3
Dimensions given in millimeters.

18.3 Dimensions of the rigging clamps

Dimensions

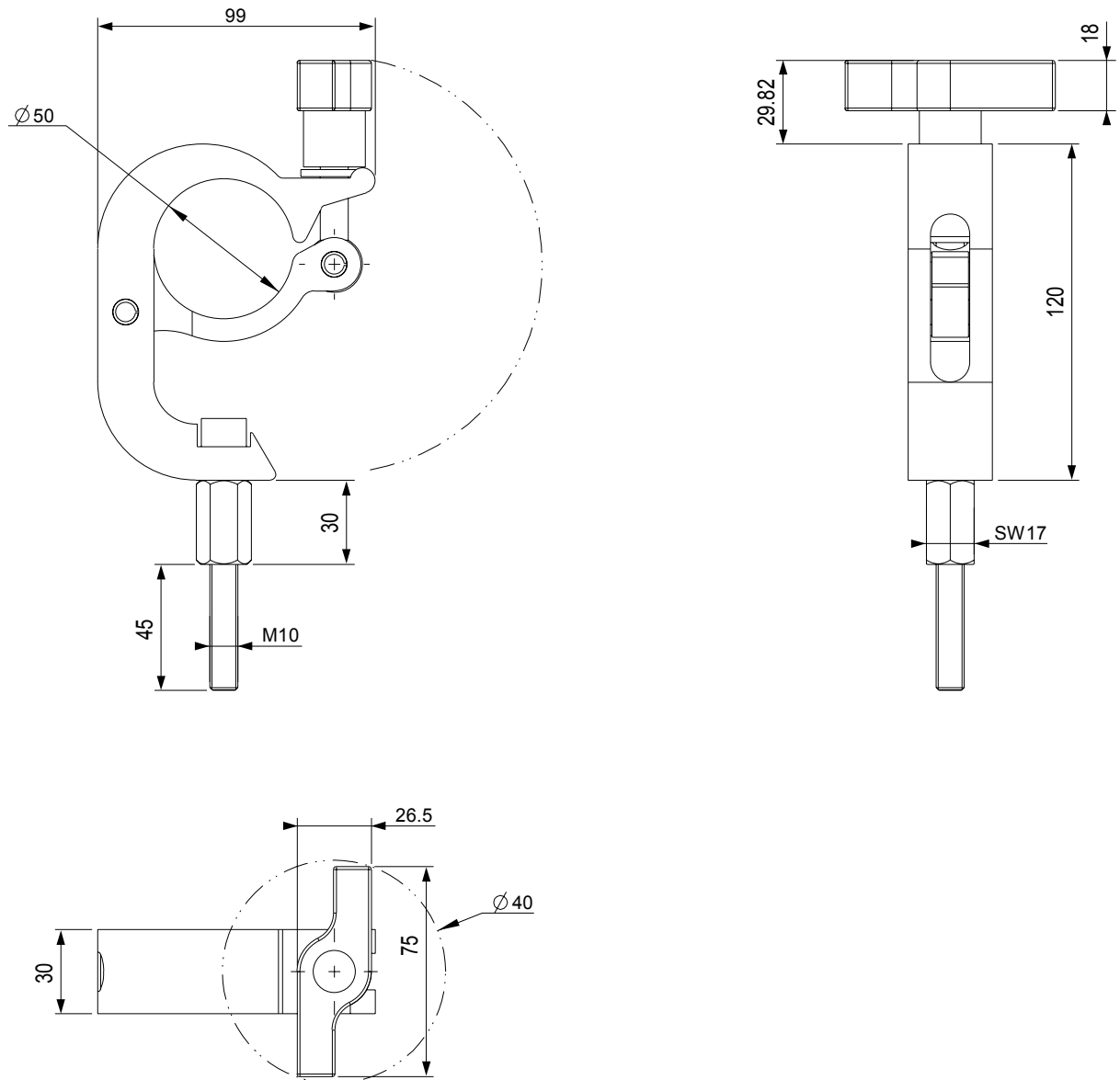

Image 18-4
Dimensions given in millimeters.

19. STANDARD SOURCE FILES

19.1 Table overview

Table overview

The following standard image files are pre-programmed in the projector.

Name ²	Fvert Hz ³	FHor kHz ⁴	Fpix MHz ⁵	Ptot ⁶	Pact ⁷	Ltot ⁸	Lact ⁹
640x350@85	85,079	37,860	31,500	832	640	445	350
640x400@85	85,079	37,860	31,500	832	640	445	400
640x480@60	59,940	31,668	25,175	800	640	525	480
640x480@72	72,888	30,288	19,687	832	640	520	480
640x480@75	74,999	37,500	31,500	840	640	500	480
640x480@85	85,009	43,270	36,000	832	640	509	480
720x400@85	85,040	37,928	35,500	936	720	446	400
800x600@56	56,251	35,157	36,001	1024	800	625	600
800x600@60	60,317	37,879	40,000	1056	800	628	600
800x600@72	72,188	48,077	50,000	1040	800	666	600
800x600@75	75,001	46,876	49,501	1056	800	625	600
800x600@85	85,062	53,674	56,250	1048	800	631	600
848x480@60	60,000	31,020	33,750	1088	848	517	480
1024x768@60	60,004	48,363	65,000	1344	1024	806	768
1024x768@70	70,068	56,475	74,999	1328	1024	806	768
1024x768@75	75,030	60,024	78,751	1312	1024	800	768
1024x768@85	84,996	68,677	94,499	1376	1024	808	768
1152x864@75	74,999	67,499	107,999	1600	1152	900	864
1280x768@60	59,870	47,776	79,499	1664	1280	798	768
1280x768@75	74,992	60,288	102,249	1696	1280	805	768
1280x768@85	84,838	68,634	117,502	1712	1280	809	768
1280x768RB@60	59,994	47,396	68,250	1440	1280	790	768
1280x960@60	59,999	59,999	107,998	1800	1280	1000	960
1280x960@85	85,005	85,940	128,505	1728	1280	1011	960
1280x1024@60	60,018	63,980	107,997	1688	1280	1066	1024
1280x1024@75	75,023	79,974	134,997	1688	1280	1066	1024
1280x1024@85	85,027	91,149	157,506	1728	1280	1072	1024
1360x768@60	59,898	47,619	85,333	1792	1360	795	768
1400x1050@50	50,015	54,517	94,641	1736	1400	1090	1050
1400x1050@60	59,979	65,317	121,751	1864	1400	1089	1050
1400x1050@75	74,866	82,277	155,998	1896	1400	1099	1050
1400x1050@85	84,958	93,879	179,497	1912	1400	1105	1050

2. Name: name of file, contains the settings.
3. Fvert Hz: vertical frame frequency of the source
4. FHor kHz: horizontal frequency of the source
5. Fpix MHz: pixel frequency
6. Ptot : total pixels on one horizontal line.
7. Pact: active pixels on one horizontal line.
8. Ltot: total lines in one field
9. Lact: active lines in one field.

19. Standard Source Files

Name ²	Fvert Hz ³	FHor kHz ⁴	Fpix MHz ⁵	Ptot ⁶	Pact ⁷	Ltot ⁸	Lact ⁹
1400x1050RB@60	59,946	64,742	100,997	1560	1400	1080	1050
1600x1200@60	60,001	75,002	162,004	2160	1600	1250	1200
1600x1200@65	64,998	81,248	175,496	2160	1600	1250	1200
1600x1200@70	69,997	87,497	188,993	2160	1600	1250	1200
1600x1200@75	74,998	93,747	202,414	2160	1600	1250	1200
1600x1200@85	84,998	106,247	229,494	2160	1600	1250	1200
1792x1344@60	60,000	83,640	204,751	2448	1792	1394	1344
1792x1344@75	74,996	106,270	260,999	2456	1792	1417	1344
1856x1392@60	59,995	86,333	218,251	2528	1856	1439	1392
1920x1140@60	60,001	90,001	234,002	2600	1920	1500	1140
1920x1200@60	59,883	74,555	193,235	2592	1920	1245	1200
1920x1200RB@60	59,952	74,041	154,006	2080	1920	1235	1200
1920x1440@60	60,001	90,001	234,002	2600	1920	1500	1200
hd-1280x720@60p	60,001	45,000	74,251	1650	1280	750	720
hd-1920x1035@30i	60,000	33,720	74,184	2200	1920	562	517
hd-1920x1080@24p	24,000	27,000	74,250	2750	1920	1125	1080
hd-1920x1080@24sf	48,001	54,002	148,504	2750	1920	1125	1080
hd-1920x1080@25i	50,044	28,125	74,249	2640	1920	562	540
hd-1920x1080@25p	25,000	28,125	74,249	2640	1920	1125	1080
hd-1920x1080@30i	60,000	33,720	74,184	2200	1920	562	540
hd-1920x1080@30p	30,000	33,750	74,249	2200	1920	1125	1080
hd-1920x1080@25i	50,000	31,25	74,250	2376	1920	625	540
hd-1920x1080@60p	60,011	67,513	148,528	2200	1920	1125	1080
VIDEO525	62,437	15,734	13,500	858	712	252	242
VIDEO525p	59,940	31,468	27,000	858	712	525	484
VIDEO625	50,080	15,625	13,500	864	702	312	287
VIDEO625p	50,080	31,250	27,000	864	702	625	574
no-signal	100,00	20,000	8,000	400	300	200	100
no-signal-i	100,00	20,000	8,000	400	300	200	100

Table 19-1

20. DMX CHART

Overview

- DMX chart, basic
- DMX chart, Extended
- DMX chart, Full

20.1 DMX chart, basic

Overview

Chan nel	Function	Value	Action
1	Intensity	0 - 5	Mechanical shutter
		0 - 255	Electronic contrast
2	Function selection	0 - 7	no function
		8 - 15	Layout 1
		16 - 23	Layout 2
		24 - 31	Layout 3
		32 - 39	Layout 4
		40 - 47	Layout 5
		48 - 55	Layout 6
		56 - 63	Layout 7
		64 - 71	Layout 8
		72 - 79	Layout 9
		80 - 87	Layout 10
		88 - 95	Input select 1
		96 - 103	Input select 2
		104 - 111	Input select 3
		112 - 119	Input select 4
		120 - 127	
		128 - 135	
		136 - 143	
		144 - 151	
152 - 159			
160 - 167			
168 - 175			
176 - 183			
184 - 207			
208 - 215	Power On / Lamp On		
216 - 223	Power Off / Lamp Off		
224 - 255			

20.2 DMX chart, Extended

Overview

Channel	Function	Value	Default	Actions
1	Intensity	0 - 5		Mechanical shutter closed
		0 - 255		Contrast 0 - channel 3
2	Brightness	0 - 255	128	Adjusts the brightness between 0 and 100% (SLM/XLM doesn't adjust on DVI)
3	Contrast	0 - 255	128	Adjusts the contrast between 0 and 100% (SLM/XLM doesn't adjust on DVI)
4	Input selection	0 - 7		No function
		8 - 15		Layout 1 (execution takes 5 sec)
		16 - 23		Layout 2 (execution takes 5 sec)
		24 - 31		Layout 3 (execution takes 5 sec)
		32 - 39		Layout 4 (execution takes 5 sec)
		40 - 47		Layout 5 (execution takes 5 sec)
		48 - 55		Layout 6 (execution takes 5 sec)
		56 - 63		Layout 7 (execution takes 5 sec)
		64 - 71		Layout 8 (execution takes 5 sec)
		72 - 79		Layout 9 (execution takes 5 sec)
		80 - 87		Layout 10 (execution takes 5 sec)
		88 - 95		Input select 1
		96 - 103		Input select 2
		104 - 111		Input select 3
		112 - 119		Input select 4
		120 - 127		
		128 - 135		
		136 - 143		
		144 - 151		
		152 - 159		
160 - 167				
168 - 175				
176 - 183				
184 - 255	No function			
5	Lens control	0 - 7		No function
		8 - 15		Lens shift Right
		16 - 23		No function
		24 - 31		Lens shift Left
		32 - 39		No function
		40 - 47		Lens shift up
		48 - 55		No function
		56 - 63		Lens shift down
		64 - 231		No function
		232 - 239		Return lens to center (if held for 5 seconds)
		240 - 247		Calibrate lens zoom + focus (if held for 5 seconds and channel 1 < 6)
		248 - 255		No function
		6		Foxus (MSB)
7	Focus (LSB)	0 - 255		Fine focus adjustment
8	Zoom (MSB)	0 - 255		Coarse zoom adjustment

Channel	Function	Value	Default	Actions
9	Zoom (LSB)	0 - 255		Fine zoom adjustment
10	Control	0 - 7		Lamp power 100%
		8 - 15		Lamp power 98%
		16 - 23		Lamp power 96%
		24 - 31		Lamp power 94%
		32 - 39		Lamp power 91%
		40 - 47		Lamp power 89%
		48 - 55		Lamp power 86%
		56 - 63		Lamp power 84%
		64 - 71		Lamp power 82%
		72 - 79		Lamp power 80%
		80 - 87		Lamp power 78%
		88 - 95		Lamp power 76%
		96 - 103		Lamp power 74%
		104 - 111		Lamp power 72%
		112 - 119		Lamp power 70%
		120 - 127		Lamp power 68%
		128 - 135		Lamp power 66%
		136 - 143		Lamp power 64%
		144 - 151		Lamp power 62%
		152 - 159		Lamp power 60%
160 - 167		No function		
168 - 175		DMX buffer 4 (Not used)		
176 - 183		DMX buffer 8 (Not used)		
184 - 191		DMX buffer off (Not used)		
192 - 199		DMX buffer clear (Not used)		
200 - 207		No function		
208 - 215		Power On / Lamp On (if held for 5 seconds)		
216 - 223		Stand by / Lamp Off (if held for 5 seconds)		
224 - 255		No function		

20.3 DMX chart, Full

Overview

Channel	Function	Value	Default	Action
1	Intensity	0 - 5		Mechanical shutter closed
		6 - 255		Contrast 0 - channel 3
2	Brightness	0 - 255	128	Adjusts the brightness between 0 and 100% (SLM/XLM doesn't adjust on DVI)
3	Contrast	0 - 255	128	Together with channel 1

20. DMX chart

Chan nel	Function	Value	Default	Action
4	Input selection	0 - 7		No function
		8 - 15		Layout 1 (execution takes 5 sec)
		16 - 23		Layout 2 (execution takes 5 sec)
		24 - 31		Layout 3 (execution takes 5 sec)
		32 - 39		Layout 4 (execution takes 5 sec)
		40 - 47		Layout 5 (execution takes 5 sec)
		48 - 55		Layout 6 (execution takes 5 sec)
		56 - 63		Layout 7 (execution takes 5 sec)
		64 - 71		Layout 8 (execution takes 5 sec)
		72 - 79		Layout 9 (execution takes 5 sec)
		80 - 87		Layout 10 (execution takes 5 sec)
		88 - 95		Input select 1
		96 - 103		Input select 2
		104 - 111		Input select 3
		112 - 119		Input select 4
		120 - 127		
		128 - 135		
		136 - 143		
		144 - 151		
		152 - 159		
160 - 167				
168 - 175				
176 - 183				
184 - 255	No function			
5	Function select	0 - 31		No function
		32 - 63		Focus motor
		64 - 95		Zoom motor
		96 - 127		Lens shift Right Left
		128 - 159		Lens shift Up Down
		160 - 191		Power On / Lamp On (together with channel 6 and 7 held in 255 for 5 sec)
		192 - 223		Stand By / Lamp Off (together with channel 6 and 7 held in 255 for 5 sec)
		224 - 255		Return lens to center position (if held for 5 seconds)
6	Motor Go >>	0 - 31		Stop
		32 - 63		Run
		64 - 223		No function
		224 - 255		Command (see channel 5)
7	Motor Go <<	0 - 31		Stop
		32 - 63		Run
		64 - 223		No function
		224 - 255		Command (see channel 5)
8	Free	0 - 255		

Channel	Function	Value	Default	Action
9	Lamp Power	0 - 26	0	Powered at 100%
		27 - 52		Powered at 98%
		53 - 79		Powered at 96%
		80 - 105		Powered at 94%
		106 - 131		Powered at 91%
		132 - 157		Powered at 89%
		158 - 183		Powered at 86%
		184 - 209		Powered at 84%
		210 - 235		Powered at 82%
		236 - 255		Powered at 80%
10	Free	0 - 255		

21. TROUBLESHOOTING

21.1 Error codes

Overview

When the error code is preceded by a '-' sign, then the error means a real error for the projector.

When the error code is preceded by a '+' sign, then the error code means a warning. The projector does not fail yet, but take care for the warning and try to resolve the problem. A warning state can turn into an error state.

Not all error codes can have two states. When the state is available, it is indicated by a Yes in the overview table. When the state is not available, it is indicated by a No.

Error code	Description	Error	Warning	Caused by	Action
1000 ↓ 1017	Wrong lamp parameters	Yes	-	Wrong lamp/ no communication with lamp	Check lamp type Call a qualified service engineer
1499					
1498					
1699	Formatter busy				
1698	Formatter address				
1697	Formatter init failed	Yes	-	no communication with formatter ctrl	Call a qualified service engineer
1696	Formatter ctrl init failed	Yes	-	no communication with formatter ctrl	Call a qualified service engineer
1695	Red form. start failed	Yes	-	no communication with red formatter	Call a qualified service engineer
1694	Green form. start failed	Yes	-	no communication with green formatter	Call a qualified service engineer
1693	Blue form. start failed	Yes	-	no communication with blue formatter	Call a qualified service engineer
1692	Form. PWRGood	Yes	-	formatter 'Power Good' signal not OK	Call a qualified service engineer
2000	No lps detected	Yes	-	no communication with lamp power supply	Call a qualified service engineer
2001	Mains voltage too low	Yes	-	mains voltage too low	
2002	Lamp start failed	Yes	-	Hot restrike Lamp with many strikes maximum run time exceeded Lamp or LPS or SPG failed	Let cool down the lamp for at least 5 minutes. Retry a few times. Replace the lamp with a new one Replace LPS or SPG or cabling.
2003	Main voltage too high	Yes	-	mains voltage too high	
2004	Lamp goes out	Yes	-		Call qualified service engineer
2005	Lamp stop failed	Yes	-		Call qualified service engineer
2201	PFC start failed	Yes	-	LPS (address 0x20)	Replace LPS
2501	PFC start failed	Yes	-	LPS (address 0x22)	Replace LPS
2801	PFC start failed	Yes	-	LPS (address 0x28)	Replace LPS
2202	LPS start failed	Yes	-	LPS (address 0x20)	Replace LPS
2502	LPS start failed	Yes	-	LPS (address 0x22)	Replace LPS

21. Troubleshooting

Error code	Description	Error	Warning	Caused by	Action
2802	LPS start failed	Yes	-	LPS (address 0x28)	Replace LPS
2203	BOOST start failed	Yes	-	LPS (address 0x20)	Replace LPS
2503	BOOST start failed	Yes	-	LPS (address 0x22)	Replace LPS
2803	BOOST start failed	Yes	-	LPS (address 0x28)	Replace LPS
2206	Lamp ignition failed	Yes	-	hot restrike, lamp with many strikes, maximum run time exceeded	Let cool down the lamp for at least 3 minutes. Replace the lamp or SPG with a new one If problem persists, call a qualified service engineer
2506	Lamp ignition failed	Yes	-	hot restrike, lamp with many strikes, maximum run time exceeded	Let cool down the lamp for at least 3 minutes. Replace the lamp or SPG with a new one If problem persists, call a qualified service engineer
2806	Lamp ignition failed	Yes	-	hot restrike, lamp with many strikes, maximum run time exceeded	Let cool down the lamp for at least 3 minutes. Replace the lamp or SPG with a new one If problem persists, call a qualified service engineer
2207	Lamp voltage range	Yes	-	lamp voltage too high or too low	Replace lamp
2507	Lamp voltage range	Yes	-	lamp voltage too high or too low	Replace lamp
2807	Lamp voltage range	Yes	-	lamp voltage too high or too low	Replace lamp
2208	Lamp power range	Yes	-	lamp voltage too high or too low	Replace lamp
2508	Lamp power range	Yes	-	lamp voltage too high or too low	Replace lamp
2808	Lamp power range	Yes	-	lamp voltage too high or too low	Replace lamp
4000	Incompatible hardware	Yes	No	Incompatible hardware used	Change to correct hardware
4199	FIB reset failed	Yes	-	no communication with FIB	Call a qualified service engineer
5098	Flash full	Yes	-	Internal Backup device has reached its maximum capacity	Call a qualified service engineer
5097	Flash management full	Yes	-	Internal Backup device has reached its maximum capacity	Call a qualified service engineer
5096	Storing unsuccessful	Yes	-	Storing the custom settings into internal backup device has failed	If problem persists, call a qualified service engineer
5095	Restoring unsuccessful	Yes	-	Restoring the custom settings from internal backup device has failed	If problem persists, call a qualified service engineer
6099					
6098					
7698	Light pipe temp high	Yes	Yes	High temperature on light pipe entry	If problem persists, call a qualified service engineer
7697	Light pipe temp open	Yes	Yes	Temperature sensor on light pipe not connected	Call a qualified service engineer
7696	Light pipe temp short	Yes	Yes	Temperature sensor on light pipe shorted	Call a qualified service engineer
7695	Red front DMD temp low	No	Yes	Low temperature on red DMD	Switching on the lamp will heat up the DMD

Error code	Description	Error	Warning	Caused by	Action
7694	Red front DMD temp high	Yes	Yes	High temperature on red DMD	Check if air slots are free. Clean air filters. If problem persists, call a qualified service engineer
7693	Red front DMD temp open	Yes	Yes	Temperature sensor on Red DMD not connected	Call a qualified service engineer
7692	Red front DMD temp short	Yes	Yes	Temperature sensor on Red DMD shorted	Call a qualified service engineer
7691	Green front DMD temp low	No	Yes	Low temperature on green DMD	Switching on the lamp will heat up the DMD
7690	Green front DMD temp high	Yes	Yes	High temperature on green DMD	Check if air slots are free. Clean air filters. If problem persists, call a qualified service engineer
7689	Green front DMD temp open	Yes	Yes	Temperature sensor on green DMD not connected	Call a qualified service engineer
7888	Green front DMD temp short	Yes	Yes	Temperature sensor on green DMD shorted	Call a qualified service engineer
7687	Blue front DMD temp low	Yes	-	Low temperature on blue DMD	Switching on the lamp will heat up the DMD
7686	Blue front DMD temp high	Yes	Yes	High temperature on blue DMD	Check if air slots are free. Clean air filters. If problem persists, call a qualified service engineer
7685	Blue front DMD temp open	Yes	Yes	Temperature sensor on blue DMD not connected	Call a qualified service engineer
7684	Blue front DMD temp short	Yes	Yes	Temperature sensor on blue DMD shorted	Call a qualified service engineer
7676	Front block temp high	Yes	Yes	High temperature on front DMD cooling block	Check if air slots are free. Clean air filters. If problem persists, call a qualified service engineer
7675	Front block temp open	Yes	Yes	Temperature sensor on front cooling block not connected	Call a qualified service engineer
7674	Front block temp short	Yes	Yes	Temperature sensor on front cooling block shorted	Call a qualified service engineer
7672	Red block temp high	Yes	Yes	High temperature on red DMD cooling block	Check if air slots are free. Clean air filters. If problem persists, call a qualified service engineer
7671	Red block temp open	Yes	Yes	Temperature sensor on red DMD cooling block not connected	Call a qualified service engineer
7670	Red block temp short	Yes	Yes	Temperature sensor on red DMD cooling block shorted	Call a qualified service engineer
7668	Green block temp high	Yes	Yes	High temperature on green DMD cooling block	Check if air slots are free. Clean air filters. If problem persists, call a qualified service engineer
7667	Green block temp open	Yes	Yes	Temperature sensor on green DMD cooling block not connected	Call a qualified service engineer
7666	Green block temp short	Yes	Yes	Temperature sensor on green DMD cooling block shorted	Call a qualified service engineer

21. Troubleshooting

Error code	Description	Error	Warning	Caused by	Action
7664	Blue block temp high	Yes	Yes	High temperature on blue DMD cooling block	Check if air slots are free. Clean air filters. If problem persists, call a qualified service engineer
7663	Blue block temp open	Yes	Yes	Temperature sensor on blue DMD cooling block not connected	Call a qualified service engineer
7662	Blue block temp short	Yes	Yes	Temperature sensor on blue DMD cooling block shorted	Call a qualified service engineer
7660	Engine air temp high	Yes	Yes	High temperature on engine	Check if air slots are free. Clean air filters. If problem persists, call a qualified service engineer
7659	Engine air temp open	Yes	Yes	Temperature sensor on engine not connected	Call a qualified service engineer
7658	Engine air temp short	Yes	Yes	Temperature sensor on engine shorted	Call a qualified service engineer
7999	Fan speed cathode too low	Yes	Yes	fan is running too slow or not at all	If problem persists, call a qualified service engineer
7998	Fan speed cathode high	-	Yes		
7997	Fan speed anode too low	Yes	Yes	fan is running too slow or not at all	If problem persists, call a qualified service engineer
7996	Fan speed anode high	-	Yes		
7995	Fan speed engine too low	Yes	Yes	fan is running too slow or not at all	If problem persists, call a qualified service engineer
7994	Fan speed engine high	-	Yes		
7993	Fan speed cold mirror too low	Yes	Yes	fan is running too slow or not at all	If problem persists, call a qualified service engineer
7992	Fan speed cold mirror high				
7991	Fan speed heat ex. too low	Yes	Yes	fan is running too slow or not at all	If problem persists, call a qualified service engineer
7990	Fan speed heat ex. high	-	Yes		
7989	Fan speed smps 1 too low	Yes	Yes	fan is running too slow or not at all	If problem persists, call a qualified service engineer
7987	Fan speed smps 2 too low	Yes	Yes	fan is running too slow or not at all	If problem persists, call a qualified service engineer
7985	Red DMD temp low	No	Yes	low temperature on dmd	turning on the lamp will heat up the dmd
7984	Red DMD temp high	Yes	Yes	high temperature on dmd	check if air slot are free; clean air filters If problem persists, call a qualified service engineer
7983	Green DMD temp low	No	Yes	low temperature on dmd	turning on the lamp will heat up the dmd
7982	Green DMD temp high	Yes	Yes	high temperature on dmd	check if air slot are free; clean air filters If problem persists, call a qualified service engineer
7981	Blue DMD temp low	No	Yes	low temperature on dmd	turning on the lamp will heat up the dmd

Error code	Description	Error	Warning	Caused by	Action
7980	Blue DMD temp high	Yes	Yes	high temperature on dmd	check if air slot are free; clean air filters If problem persists, call a qualified service engineer
7978	Lamp temp high	Yes	Yes	high temperature lamp	check if air slot are free; clean air filters If problem persists, call a qualified service engineer
7976	SMPS HS temp high	Yes	Yes	high temperature on smps	check if air slot are free; clean air filters If problem persists, call a qualified service engineer
7974	Ambient temp high	Yes	Yes	ambient temperature above specification	check ambient conditions check if air slot are free; clean air filters
7973	Fan 1 voltage low	Yes	Yes	voltage on fan group 1 too low (= cathode fan)	Hardware problem in Fan control board, call a qualified service engineer
7972	Fan 1 voltage high	-	Yes	voltage on fan group 1 too high	Hardware problem in Fan control board, call a qualified service engineer
7971	Fan 2 voltage low	Yes	Yes	voltage on fan group 2 too low (= anode fan)	Hardware problem in Fan control board, call a qualified service engineer
7970	Fan 2 voltage high	-	Yes	voltage on fan group 2 too high	Hardware problem in Fan control board, call a qualified service engineer
7969	Fan 3 voltage low	Yes	Yes	voltage on fan group 3 too low (= engine fan)	Hardware problem in Fan control board, call a qualified service engineer
7968	Fan 3 voltage high	-	Yes	voltage on fan group 3 too high	Hardware problem in Fan control board, call a qualified service engineer
7967	Fan 4 voltage low	Yes	Yes	voltage on fan group 4 too low (= cold mirror + head ex. fan)	Hardware problem in Fan control board, call a qualified service engineer
7966	Fan 4 voltage high	-	Yes	voltage on fan group 4 too high (= cold mirror + head ex. fan)	Hardware problem in Fan control board, call a qualified service engineer
7965	Fan 5 voltage low	Yes	Yes	voltage on fan group 5 too low (= mains input fan)	Hardware problem in Fan control board, call a qualified service engineer
7964	Fan 5 voltage high	-	Yes	voltage on fan group 5 too high (mains input fan)	Hardware problem in Fan control board, call a qualified service engineer
7963	Fan 6 voltage low	Yes	Yes	voltage on fan group 6 too low (= smps fan)	Hardware problem in Fan control board, call a qualified service engineer
7962	Fan 6 voltage high	-	Yes	voltage on fan group 6 too low (= smps fan)	Hardware problem in Fan control board, call a qualified service engineer
7959	Pump voltage low	Yes	Yes	voltage on pump too low	If problem persists, call a qualified service engineer
7958	Pump voltage high	-	Yes	voltage on pump too high	If problem persists, call a qualified service engineer
7957	30V voltage low	No	Yes	supply voltage for fans too low	If problem persists, call a qualified service engineer
7956	30V voltage high	No	Yes	supply voltage for fans too high	If problem persists, call a qualified service engineer
7955	VTEC voltage low	No	Yes	supply voltage for DMD cooling too low	If problem persists, call a qualified service engineer

21. Troubleshooting

Error code	Description	Error	Warning	Caused by	Action
7954	VTEC voltage high	No	Yes	supply voltage for DMD cooling too high	If problem persists, call a qualified service engineer
7953	VMTR voltage low	No	Yes	supply voltage for motors too low	If problem persists, call a qualified service engineer
7952	VMTR voltage high	No	Yes	supply voltage for motors too high	If problem persists, call a qualified service engineer
7945	5V voltage low	No	Yes	supply voltage for electronics too low	If problem persists, call a qualified service engineer
7944	5V voltage high	No	Yes	supply voltage for electronics too high	If problem persists, call a qualified service engineer
7943	5V FIB voltage low	No	Yes	supply voltage for engine electronics too low	If problem persists, call a qualified service engineer
7942	5V FIB voltage high	No	Yes	supply voltage for engine electronics too high	If problem persists, call a qualified service engineer
7941	5V PMP voltage low	No	Yes	supply voltage for drawer electronics too low	If problem persists, call a qualified service engineer
7940	5V PMP voltage high	No	Yes	supply voltage for drawer electronics too high	If problem persists, call a qualified service engineer
7939	Prism	No	Yes	projection lens too close to prism	move lens away from prism (up and/or right)
7938	Lamp not inserted well	Yes	No	lamp module not correctly inserted	reinsert lamp module and screw firmly
7937	Waterflow	Yes	No	bad or no water flow in cooling circuit	If problem persists, call a qualified service engineer
7936	Tilt	No	Yes	tilt angle is out of specifications	Correct projection installation. Change the tilting so that the tilt angle becomes within the specifications.
7935	Engine not well inserted	Yes	No	engine is not correctly inserted	If problem persists, call a qualified service engineer
7934	FIB not inserted well	Yes	No	formatter interface board is not correctly inserted	If problem persists, call a qualified service engineer
7931	PFC HS high temp	Yes	Yes	high temperature on smps	check if air slot are free; clean air filters If problem persists, call a qualified service engineer
7929	SMPS HS high temp	Yes	Yes	high temperature on smps	check if air slot are free; clean air filters If problem persists, call a qualified service engineer
7928	Overtemp	Yes	No	extreme overheating of dmd's or lamp	If problem persists, call a qualified service engineer
7927	fan speed mains input too low	Yes	Yes	fan is not running or is running too slow	If problem persists, call a qualified service engineer
7926	fan speed mains input high	-	Yes		
8000	Opening shutter failed	No	Yes		If problem persists, call a qualified service engineer
8001	Closing shutter failed	No	Yes		If problem persists, call a qualified service engineer
8002	Lamp EEPROM	No	Yes		If problem persists, call a qualified service engineer
9000	Scaler unit failed	Yes	-	Initialization of the scaler failed	If problem persists, call a qualified service engineer
9198	Scaler pixel clock too high	Yes	-	BW or refresh rate of input source too high	

Error code	Description	Error	Warning	Caused by	Action
9398	Maximum image files reached	Yes	No	Reaching the maximum allowed number of files	Delete some unnecessary files
10498	Unsupported module	Yes	No	Module with obsolete firmware	Call a qualified service engineer

22. SPECIFICATIONS

Overview

- Specifications FLM R22+
- Specifications FLM 5 cable input (multi purpose)
- Specifications FLM HDSDI – SDI input
- Specifications FLM DVI input
- Specifications FLM DVI HDCP input

22.1 Specifications FLM R22+

Overview

Light Output

22.000 Center Lumen

Resolution

1400 x 1050 (native)

Contrast ratio

1800 : 1 (full field)

High contrast mode:

2400 : 1 (full field)

Lamp

3 kW Xenon

Warranty universal lamphouse: 750 Hrs

Ambient temperature

Max 40°C (104°F)

Power consumption

3600 W

Mains Voltage

200 - 240 V

Weight

99 kg (220 lbs)

Dimensions

WxLxH

707 x 1025 x 548 mm

(27.8 x 40.3 x 21.5 inch)

incl. carrying handle + rigging points

Noise Level

56 dBA (at 40°C)

ScenergiX

Standard horizontal and vertical electronic edge blending

22. Specifications

Network connection

10/100 base-T

Picture-in-picture

2 sources simultaneous

Input source compatibility

Max. input: up to QXGA (2048 x 1536)

Inputs

Modular Inputs:

- Configurable 5 cable (BNC)
- DVI
- (HD)SDI (+ loop through)

Throw Ratio

Lens	Throw ratio
TLD (HB) 0.8	0.75
TLD (HB) 1.2	1.1
TLD (HB) 1.2+	1.23
TLD (HB) 1.6 - 2.0	1.45 - 1.85
TLD (HB) 2.0 - 2.8	1.85 - 2.55
TLD (HB) 2.8 - 5.0	2.55 - 4.55
TLD (HB) 5.0 - 8.0	4.55 - 7.3

Dust filters

Dense, high quality microfilters available as spare kit, in a 6-pack & 24-pack

Order Information

Projector: R9004500

Spare lamp (universal lamp house): R9854420

6-pack dust filters: R9454470

24-pack dust filters: R9454480

RGB HV module: R9854440

FLM/SLM adaptor plate: R9854490

FLM carry handle: R9854530

FLM flight case: R9854510

Brightness uniformity

> 90% for the total screen

Display

3 Chip DLP SXGA+ (resolution of 1400 x 1050 pixels (aspect ratio 4:3)).

Lens Shift

Vertical: -10% to +110%

Horizontal: -50% to +50%

(small differences occur per lens type)

(short throw lenses have less shift)

On board display server

Ethernet control standard
remote control projector over ethernet via Projector Toolset

Outputs

HDSDI/ SDI loop out

Communication

- 1x RS-232C IN (D-9 connector)
- 1x RS-232C OUT (D-9 connector)
- 1x RS-232C IN (XLR connector)
- 2x prop. protocol (RJ45 connector)
- xlr and mini-jack for wired remote control

Compatibility

- All current video sources (PAL, SECAM, NTSC) in Composite, S-VHS, Component or RGB formats
- All current HDTV sources
- All computer graphics formats from VGA, SVGA, XGA, SXGA, full HD, UXGA to QXGA
- Most Macintosh computers
- Electronic workstations with a resolution up to QXGA (2048 x 1536 pixels at 60 Hz)
- Most computer sources with a pixel clock up to 300 MHz
- DVI sources up to DC2K (2048x1080)

Power Dissipation

max 11953BTU/h

Features

- Picture in picture
- Seamless switching with effects
- Standard light shutter
- Rigging point
- Carrying handle
- High contrast mode
- P7 color processing

Screen size

From 1-12m / 3-39ft.recommended

Scan Frequencies

Pixel clock >162Mhz (QXGA 60hz)

Lens encoders

On zoom and focus (with TLD lenses)

Safety Regulations

Compliant with UL1950 and EN60950

Electromagnetic Interference

Complies with FCC rules & regulations, part 15 Class A and CE EN55022 Class A

Lenses

Lens	Order nr
TLD (HB) 0.8	R9842040
TLD (HB) 1.2	R9840770

22. Specifications

TLD (HB) 1.2+	R9840775
TLD (HB) 1.6 - 2.0	R9842060
TLD (HB) 2.0 - 2.8	R9842080
TLD (HB) 2.8 - 5.0	R9842100
TLD (HB) 5.0 - 8.0	R9842120

Sealed DLP™ core

Standard

Convergence

Max allowed convergence drift is 0.5 pixel.

This is checked on vertical and horizontal midlines only.

Corners are not applicable for convergence error.

This is measure with TLD 1.2 lens on axis.

Shipping Dimensions

Width: 92 cm

Height: 95 cm

Depth: 123 cm

Floor Space: 1,1316 m²

Volume: 1,075020 m³

Gross Weight: 161 kg

22.2 Specifications FLM 5 cable input (multi purpose)

Front view 5 cable input

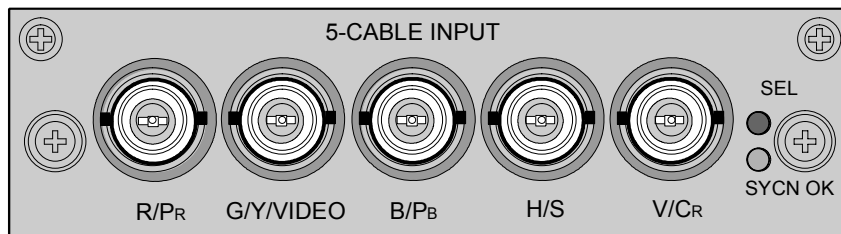

Image 22-1

Signal connectivity

Input signal	R / P _R	G / Y / VIDEO	B / P _B	H / S	V / C _R
RGBHV	R	G	B	H	V
RGBS	R	G	B	S	—
RGsB	R	Gs sync on green	B	—	—
Composite Video	—	VIDEO	—	—	—
Super Video	—	Y Luma	—	—	C Chroma

Input signal	R / P _R	G / Y / VIDEO	B / P _B	H / S	V / C _R
Component Video - SS	P _R / (R - Y)	Y	P _B / (B - Y)	S composite sync or VIDEO as sync	—
Component Video - SOY	P _R / (R - Y)	Ys	P _B / (B - Y)	—	—

Specifications

- Data and HD sources RGB and YUV [HS/VS, CS or SOG(Y)]:
 - Pixel clock maximum 275 MHz
 - 8 bit digital output
- Video sources CVBS, S-VIDEO, RGB and YUV [CS, CV or SOG(Y)]:
 - PAL B/D/I/G/H, PAL60, PAL M, PAL N, PAL Nc
 - NTSC M/J, NTSC 4.43
 - SECAM B/D/G/K/L
 - 525i, 625i, 525p, 625p
 - Macrovision copy protection robust
 - 10 bit digital output
 - Standard images "video525" and "video625"
- Automatic detection of sync inputs but with manual override:
 - automatic modes : RGB, YUV, VIDEO
 - manual modes : RGB HS/VS - CS, RGB CV, RGB SOG, YUV HS/VS - CS, YUV CV, YUV SOY, CVBS, S-VIDEO
- Possible to disconnect 75 Ohm terminations on HS and VS (TTL sync level selection)
- Signal requirements:
 - Component Video (BNC)
 - o R-Y : 0,7Vpp ±3dB 75 Ohm termination.
 - o Ys : 1Vpp ±3dB (0,7V Luma +0,3V Sync) 75 Ohm termination.
 - o B-Y : 0,7Vpp ±3dB 75 Ohm termination.
 - RG(s)B
 - o R : 0,7Vpp ±3dB 75 Ohm termination.
 - o G(s) : 1Vpp ±3dB (0,7Vpp G + 0,3Vpp Sync) 75 Ohm termination.
 - o B : 0,7Vpp ±3dB 75 Ohm termination.
- Diagnostic LED's on front panel:
 - Green LED: Lights up in case input module is selected
 - Yellow LED: Lights up in case sync detected

22.3 Specifications FLM HDSDI – SDI input

Input front view HDSDI – SDI input

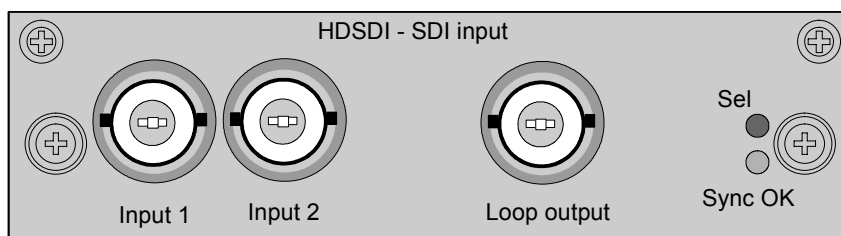

Image 22-2

Specifications

- SD SMPTE 259M-C and HD SMPTE 292M input data
- 2 inputs (BNC), 1 active loop-through output (BNC) of selected input
- Automatic selection of active input with manual override
- 10 bit digital output
- Diagnostic LED's on front panel:
 - Green LED: Lights up in case input module is selected
 - Yellow LED: Lights up in case sync detected
- SDI: 270 Mbit/s transmission (SMPTE 259M-C).
- SDI: 525/625 interlaced.
- Coax (75 Ohm).
- Supported HDSDI standards:
 - Progressive:
 - o 1280x720/60/1:1/ (SMPTE 296M)
 - o 1280x720/59.94/1:1/ (SMPTE 296M)
 - o 1920x1080/30/1:1/ (SMPTE 274M)
 - o 1920x1080/29.97/1:1/ (SMPTE 274M)
 - o 1920x1080/25/1:1/ (SMPTE 274M)
 - o 1920x1080/24/1:1/ (SMPTE 274M)
 - o 1920x1080/23.98/1:1/ (SMPTE 274M)
 - Interlaced:
 - o 1920x1035/60/2:1/ (SMPTE 260M)
 - o 1920x1035/59.94/2:1/ (SMPTE 260M)
 - o 1920x1080/60/2:1/ (SMPTE 274M)
 - o 1920x1080/59.94/2:1/ (SMPTE 274M)
 - o 1920x1080/50/2:1/ (SMPTE 274M)
 - o 1920/1080/50/2:1 (1250)/ (SMPTE 295M)
 - o 1920x1080/24/Segmented/ (SMPTE 274M)
 - o 1920x1080//23.98/Segmented/ (SMPTE 274M)

22.4 Specifications FLM DVI input

Input front view

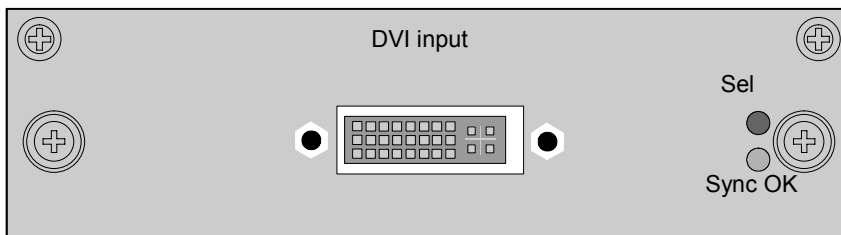

Image 22-3

Specifications

- DVI type: DVI-I (DVI-Integrated), but the analog signals are not supported. Single-link configuration.
- Single link dvi for pixelclocks up to 165MHz
- Vertical frequencies: 24 - 75 Hz
- Horizontal frequencies: 20 - 90 kHz
- Supported resolutions: up to UXGA (1600 x 1200) at 60 Hz.
- Cable lengths: up to 3 meter at UXGA speed.
- Compliance: DDC2B support according to VESA EDID Version 1.2
- Diagnostic LED's on front panel:
 - Green LED: Lights up in case input module is selected
 - Yellow LED: Lights up in case sync detected

22.5 Specifications FLM DVI HDCP input

Input front view

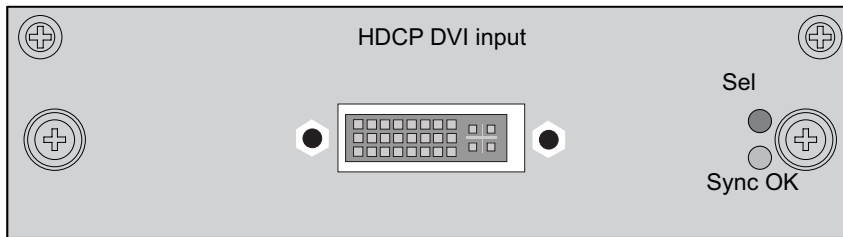

Image 22-4

Specifications

- DVI type: DVI-I (DVI-Integrated), but the analog signals are not supported. Single-link configuration.
- Supports UXGA Resolution (1600 x 1200) (Output Pixel Rates up to 165 MHz)
- True-Color, 24 Bits/Pixel, 48-Bit Dual Pixel Output Mode, 16.7M Colors at 1 or 2 Pixels Per Clock
- Digital Visual Interface (DVI) and High-Bandwidth Digital Content Protection (HDCP) Specification Compliant
- Vertical frequencies: 24 - 75 Hz
- Horizontal frequencies: 20 - 90 kHz
- Cable lengths: up to 3 meter at UXGA speed.
- Compliance: DDC2B support according to VESA EDID Version 1.2
- Diagnostic LED's on front panel:
 - Green LED: Lights up in case input module is selected
 - Yellow LED: Lights up in case sync detected

23. ORDER INFORMATION

23.1 Spare part order info

Order info:

Order info	Description
R9854490	FLM/SLM adaptor plate (for stacking an SLM projector upon an FLM projector).
R9854420	FLM lamp house (3kW lamp included).
R9854520	FLM lamp house refurbish (3kW lamp included).
R9854430	5 Cable input module.
R9854440	High bandwidth data input module (RGB).
R9854450	HDSDI - SDI input module.
R9854460	DVI input module.
R9854465	DVI HDCP input module
R848607	Cover plate for unused input slot.
R9854470	FLM front, top and bottom filters (6 pieces each).
R9854480	FLM front, top and bottom filters (24 pieces each).
R9854510	FLM flight case.
R764988	FLM remote control unit (RCU)
R820411	One rigging clamp for truss installations.
Z3499178	FLM power cord.
R9842040	TLD HB fixed lens (0.8 : 1)
R9840770	TLD HB fixed lens (1.2 : 1)
R9840775	TLD HB fixed lens (1.2+ : 1)
R9842060	TLD HB zoom lens (1.6 - 2.0 : 1)
R9842080	TLD HB zoom lens (2.0 - 2.8 : 1)
R9842100	TLD HB zoom lens (2.8 - 5.0 : 1)
R9842120	TLD HB zoom lens (5.0 - 8.0 : 1)

GLOSSARY

2:2 pull-down

The process of transferring 24-frames/sec film format into video by repeating each frame (used for PAL DVD's) as two video fields. (AD)

3:2 pull-down

Method used to map the 24 fps of film onto the 30 fps (60 fields) or 25 fps (50 fields), so that one film frame occupies three video fields, the next two, etc. It means the two fields of every other video frame come from different film frames making operations such as rotoscoping impossible, and requiring care in editing. Some sophisticated equipment can unravel the 3:2 sequence to allow frame-by-frame treatment and subsequently re-compose 3:2. The 3:2 sequence repeats every five video frames and four film frames, the latter identified as A-D. Only film frame A is fully on a video frame and so exists at one time code only, making it the editable point of the video sequence.

Art-Net DMX

DMX protocol over an Ethernet network.

Artefacts

Undesirable elements or defects in a video picture. These may occur naturally in the video process and must be eliminated in order to achieve a high-quality picture. Most common in analog are cross color and cross luminance. Most common in digital are macroblocks, which resemble pixelation of the video image.

Aspect ratio

Relation between the horizontal & vertical dimension in which the window will be displayed, e.g. 4 by 3 or 16 by 9. Can also be expressed as a decimal number, such as 1.77. The larger the ratio or decimal, the wider are less square the image.

Color space

A color space or color standard is a mathematical representation for a color. For example the RGB color space is based on a Cartesian coordinate system.

Color temperature

The coloration (reddish, white, bluish, greenish, etc.) of white in an image, measured using the Kelvin (degrees K) temperature scale. Higher temperatures output more light.

Common address

Projector will always execute the command coming from a RCU programmed with that common address.

Default Gateway

A router that serves as an entry point into and exit point out of a network. For example, a local network (LAN) may need a gateway to connect it to a wide area network (WAN) or to the Internet.

DHCP

Dynamic host configuration protocol. DHCP is a communications protocol that lets network administrators manage centrally and automate the assignment of IP addresses in an organization's network. Using the Internet Protocol, each machine that can connect to the Internet needs a unique IP address. When an organization sets up its computer users with a connection to the Internet, an IP address must be assigned to each machine. Without DHCP, the IP address must be entered manually at each computer and, if computers move to another location in another part of the network, a new IP address must be entered. DHCP lets a network administrator supervise and distribute IP addresses from a central point and automatically sends a new IP address when a computer is plugged into a different place in the network.

DMX

DMX-512 Lighting protocol, here used over Ethernet. Carries information of 512 channels from a lighting controller to lighting devices. Standardized by USITT.

Gamma

"Gamma" is a global setting that determines what gray shades are displayed between minimum input (black) and maximum input (white) for all signals. A good gamma setting helps to optimize blacks and whites while ensuring smooth transitions for the "in-between" values utilized in other colors. Thus, unlike "Brightness" and "Contrast" controls, the overall tone of your images can be lightened or darkened without changing the extremes, and all images will be more vibrant while still showing good detail in dark areas.

HDCP

High-bandwidth Digital Content Protection (HDCP) is a form of digital copy protection developed by Intel Corporation to protect digital audio and video content as it travels across DisplayPort, Digital Visual Interface (DVI), High-Definition Multimedia Interface (HDMI), Gigabit Video Interface (GVIF), or Unified Display Interface (UDI) connections. The specification is proprietary, and implementing HDCP requires a license.

HEPA

High Efficiency Particulate Absorbing

IP

Internet Protocol. The network layer of TCP/IP. Required for communication with the internet.

MAC address

Media Access Control address. Unique hardware number, used in combination with the IP-address to connect to the network (LAN or WAN).

PiP

PiP stands for "Picture in Picture" and allows to display multiple windows containing each of them an image. The windows may be of the video or data type.

Projector address

Address installed in the projector to be individually controlled.

Restricted access location

A location for equipment where both of the following paragraphs apply:

- 1) Access can only be gained by SERVICE PERSONS or by USERS who have been instructed about the reasons for the restriction applied to the location and about the precautions that shall be taken.
- 2) Access is through the use of the tool or lock and key, or other means of security, and is controlled by the authority responsible for the location.

RS232

An Electronic Industries Association (EIA) serial digital interface standard specifying the characteristics of the communication path between two devices using either D-SUB 9 pins or D-SUB 25 pins connectors. This standard is used for relatively short-range communications and does not specify balanced control lines. RS-232 is a serial control standard with a set number of conductors, data rate, word length and type of connector to be used. The standard specifies component connection standards with regard to computer interface. It is also called RS-232-C, which is the third version of the RS-232 standard, and is functionally identical to the CCITT V.24 standard. Logical '0' is > + 3V, Logical '1' is < - 3V. The range between -3V and +3V is the transition zone.

RS422

An EIA serial digital interface standard that specifies the electrical characteristics of balanced (differential) voltage, digital interface circuits. This standard is usable over longer distances than RS-232. This signal governs the asynchronous transmission of computer data at speeds of up to 920,000 bits per second. It is also used as the serial port standard for Macintosh computers. When the difference between the 2 lines is < - 0.2V that equals with a logical '0'. When the difference is > +0.2V that equals to a logical '1'.

Subnet mask

A number that is used to identify a subnetwork so that IP addresses can be shared on a local area network.

INDEX

A

- Address 52
 - Program 52
 - RCU 52
- Adjustment 49–50
 - Quick set up 49–50
 - Lens 49
 - Lens functions 50
 - Lens key 49
 - PIP 50
- Adjustment mode 55–57
 - About 55
 - LCD display menus 57
 - Local keypad 55
 - Menu memory 57
 - Navigation 56
 - On screen menus 57
 - RCU 55
 - Shortcut keys 56
 - Start up 55
 - Test patterns 57
- Air flow 18
- Align 27, 33
 - Ceiling mount 27
 - Stacked 33
 - Table mount 27
- Alignment 117–130, 132–137, 139, 141, 145
 - Blanking 130
 - Color space 133
 - Color standard 133
 - Contrast enhancement 130
 - Gamma 132
 - Internal pattern 132
 - Lens 119
 - Focus 119
 - Mid position 119
 - Shift 119
 - Zoom 119
 - Lens adjustment 119
 - Orientation 118
 - Overview flow 117, 145
 - ScenergiX 134–137, 139, 141
 - Activation 135
 - Black level 141
 - Horizontal overlap 136
 - Introduction 134
 - Preparations 135
 - Size adjustment 139
 - Vertical overlap 137
 - White level 139
 - Side keystone 120
 - Warp 121–129
 - 4 corners 127
 - About 121
 - Barrel correction 126
 - Horizontal keystone 123
 - Load warp file 129
 - Pincushion correction 126
 - Reset 128
 - Rotation 125
 - Status 122
 - Vertical keystone 124
- Art-Net activation 157
- Art-Net DMX 153–157
 - Art-Net activation 157
 - DMX address 154
 - DMX mode 156
 - DMX monitor 155
 - DMX universe 154
 - Home lens at startup 157
- Aspect ratio 82–83
 - Custom 83

B

- Background color 65
 - No signal 65
- Blanking 130
- Box content 13
- Brightness 71
- Broadcast mode 177
- Buttons 158–159
 - APA 159
 - Auto 159
 - Shortcut keys 159
 - Standby 158

C

- Card bus 41
- Ceiling mount 27
 - Align 27
- cleaning 184
 - lens 184
- Cleaning 184
 - Exterior 184
- CLO mode 113
- CLO target 114
- Color saturation 72
- Color space 133
- Color standard 133
- Color temperature 76–77
 - Custom values 77
 - Predefined values 76
- Communication 38
 - Connection 38
- Configurations 14–15
 - Front projection 14
 - Rear projection 15
- Connection 35, 37–38
 - Communication 38
 - Power 35
 - Source 37
- Connections 35, 47
 - Switching off 47
- Contrast 71
- Contrast enhancement 130
- Convergence 172
 - Service patterns 172
- Cooling circuit 183
 - Pressure 183
- Cooling liquid circuit warning 7
- Copy 108
 - Layout 108
- Cover 193
 - Removal 193
- Custom aspect ratio 83
- Custom color temperature 77

D

- Delete 107
 - Layout 107
- Diagnosis 167, 169–171
 - Fan speeds 170
 - SPI 171
 - Start up 167, 169
 - Temperatures 169
- Dimensions 201–203
 - Flight case 202
 - Projector 201
 - Rigging clamps 203
- DMX address 154
- DMX chart 207–209
 - Basic 207
 - Extended 208

- Full 209
 - DMX mode 156
 - DMX monitor 155
 - DMX universe 154
 - Download plug-in 18
 - Download Projector Toolset 18
 - Dust filter 181–183
 - Bottom 182
 - Front 181
 - Top 183
- E**
- Error codes 213
 - Error logging 172
 - Start up 172
 - Ethernet 40
 - Exterior 184
 - Cleaning 184
- F**
- Fan speeds 170
 - Diagnosis 170
 - File services 88
 - Manual load file 88
 - Film mode detection 86
 - Flight case 14
 - Front projection 14
 - Fuses 36
- G**
- Gamma 132
 - General 18
 - Download plug-in 18
 - Download Projector Toolset 18
 - General info 11
 - Getting started 43, 45, 49, 52–53
 - Operating 45
 - Projector address 52
 - Quick setup 49
 - Source selection 53
 - Terminology overview 43
 - Getting Started 43, 45, 47, 54
 - Controlling the projector 54
 - RCU & local keypad 43
 - Switching on 45
 - Using the RCU 47
- H**
- Hang up 28
 - Projector 28
 - Hue 73
- I**
- Identification 114
 - Lamp 114
 - Image 69–76, 78–79, 82–84, 86, 88–93
 - Advanced settings 84, 86
 - Clamp delay 84
 - Clamp width 84
 - Field polarity 84
 - Film mode detection 86
 - Aspect ratio 82
 - File services 88
 - Manual load file 88
 - Film mode detection 86
 - Image file services 88
 - Image services 88–92
 - Copy file 91
 - Delete file 89–90
 - File manipulations 88
 - File options 92
 - Files 88
 - Rename file 90
 - Save custom settings 93
 - Source timings 83
 - Start up 70
 - Timings 83–84
 - Advanced settings 84
 - Image file services 88
 - Image files 205
 - standard 205
 - Image services 88–93
 - Copy file 91
 - Delete file 89–90
 - File manipulations 88
 - File options 92
 - Files 88
 - Rename file 90
 - Save custom settings 93
 - Infra red 38
 - Input 59–61, 63, 65–66
 - Configuration 60
 - Input locking 61
 - Minimum delay 63
 - Module type 59
 - Native resolution 63
 - No signal 65–66
 - Background color 65
 - Shutdown 66
 - Shutdown retarding time 66
 - Overview flow 59
 - Slot module type 59
 - Source switching 65
 - Input & communication unit 186, 189
 - Install 189
 - Remove 186
 - Input balance 78–81
 - Adjusting 79
 - Black balance 80
 - Introduction 78
 - White balance 81
 - Input module 187, 190
 - Install 190
 - Remove 187
 - Input setup 59
 - About 59
 - Install 188–190, 196–199
 - Front cover 196
 - Input & communication unit 189
 - Input cover 199
 - Input module 190
 - Lamp cover 198
 - Lamp house 188
 - Side cover 197
 - Installation 11, 19
 - Requirements 11
 - Installation requirements 11–12
 - Ambient temperature 11
 - Clean air 11
 - Humidity 11
 - Image size 12

- Projector weight 11
- Screen type 11
- Internal pattern 132
 - Selection 132
- IR communication 38
- IR control 153

K

- Keystone 120

L

- Lamp 111–115, 191
 - Identification 114
 - Overview flow 111
 - Power 112–114
 - CLO mode 113
 - CLO target 114
 - Power mode 111
 - Realign 191
 - Z-axis 115
- Lamp house 185, 188
 - Install 188
 - Remove 185
- Lamp identification 114
- Lamp power 112
- Lamp power mode 111
- Language 51, 162
 - Selection 51, 162
- Laser Beams 8
- Layout 95–96, 99, 101–102, 105–109
 - Copy 108
 - Delete 107
 - Layout file services 106
 - Layout services 106–108
 - Copy 108
 - Delete 107
 - Load 106
 - Rename 107
 - Save as 108
 - Load 106
- Main window 95–96, 99
 - Position 99
 - Size 96
 - Source 96
- Overview flow 95
- PIP 101–102, 105
 - Activation 101
 - Position 105
 - Size 102
 - Source 101
 - Rename 107
 - Save as 108
 - Zoom - Focus 109
- LCD display menus 57
 - lens 184
 - cleaning 184
- Lens 23–24, 26, 119
 - Available 23
 - Focus 119
 - Formulas 24
 - Install 24
 - Mid position 119
 - Removal 26
 - Selection 23
 - Shift 119
 - Zoom 119
- Lens adjustment 119
- Lenses 23
- Load 106
 - Layout 106

M

- Maintenance 181
- Menu memory 57
- Menu position 160–161
 - Bar scale 161
 - On screen menu 160
- Minimum delay 63

N

- Native resolution 63
- Navigation 56
 - Adjustment mode 56
- Network 149–152
 - DHCP 150
 - Gateway 152
 - Introduction 150
 - IP-address 151
 - Subnet-mask 151
- No signal 65–66
 - Background color 65
 - Shutdown 66
 - Shutdown retarding time 66
- Noise reduction 75
- Notice on safety 5

O

- Off-Axis 16
- On screen menus 57
- On-Axis 16
- Order information 229
- Orientations 14–15
 - Front projection 14
 - Rear projection 15

P

- PCMCIA 41
- Phase 73
- Physical installation 23
 - Lenses 23
- PIP 100–102, 105
 - Activation 101
 - Introduction 100
 - Position 105
 - Size 102
 - Source 101
- Position 99
 - Main window 99
- Positioning 16
- Power 35
 - Connection 35
- Preset color temperature 76
- Pressure 183
 - Cooling circuit 183
- Prevent 6–8, 20
 - Battery explosion 8, 20
 - Device damage 7
 - Electrical shock 6
 - Fire hazard 8
 - Personal injury 7
- Projector 14, 16–18
 - Air inlets 18
 - Air outlets 18
 - Configurations 14
 - Orientations 14
 - Positioning 16
 - Shift range 16
 - Tilt range 17
- Projector address 52–53, 146–147
 - Address 146
 - Common address 147
 - Controlling 53
- Projector control 145–162

- Art-Net DMX 153–157
 - Art-Net activation 157
 - DMX address 154
 - DMX mode 156
 - DMX monitor 155
 - DMX universe 154
 - Home lens at startup 157
- Buttons 158–159
 - APA 159
 - Auto 159
 - Shortcut keys 159
 - Standby 158
- IR control 153
- Language 162
 - Selection 162
- Local LCD 161
- Local LCD contrast 162
- Local LCD time out 161
- Menu position 160–161
 - Bar scale 161
 - On screen menu 160
- Network 149–152
 - DHCP 150
 - Gateway 152
 - Introduction 150
 - IP-address 151
 - Subnet-mask 151
- Projector address 146–147
 - Address 146
 - Common address 147
- Serial communication 148–149
 - Baud rate setup 148
 - Interface standard 148
 - RS422 termination 149
- Projector status 38

Q

- Quick language 51
 - Selection 51
- Quick layout 51
 - Rigging key 51
 - Selection 51
- Quick set up 49–50
 - Lens 49–50
 - Lens functions 50
 - LENS key 49
 - PIP 50
 - Text on/off 49
- Quick setup 19

R

- RCU 19, 21–22
 - Possibilities 22
 - Rugged case 21
 - XLR adaptor 21
- Realign 191
 - Lamp 191
- Rear projection 15
- Refill mode 176
- Remote control 19–20, 38
 - Battery 20
- Remote Control 50
 - Lens functions 50
 - PIP 50
- Remove 185–187, 193–195
 - Front cover 193
 - Input & communication unit 186
 - Input module 187
 - Lamp cover 195
 - Lamp house 185
 - Side cover 194
- Rename 107
 - Layout 107

- Replace 181–183
 - Dust filter 181–183
 - Bottom 182
 - Front 181
 - Top 183
- Reset formatter 175
- Restore factory defaults 174
- Rigging clamps 28
- Rigging key 51
 - Quick layout selection 51
- Rigging points 28
- RS232 39
- RS422 39

S

- Safety 5–9, 20
 - Battery explosion 20
 - Cooling liquid circuit 7
 - Device damage 7
 - Electrical shock 6
 - Fire hazard 8
 - Flight cases 9
 - General 5
 - Important instructions 6
 - Personal injury 7
 - Replacement parts 8
 - Servicing 8
- Saturation 72
- Save as 108
 - Layout 108
- Save custom settings 176
- ScenergiX 134–137, 139, 141
 - Activation 135
 - Black level 141
 - Horizontal overlap 136
 - Introduction 134
 - Preparations 135
 - Size adjustment 139
 - Vertical overlap 137
 - White level 139
- Serial communication 39, 148–149
 - Baud rate setup 148
 - Interface standard 148
 - RS422 termination 149
- Service 165–178
 - Broadcast mode 177
 - Convergence 172
 - Diagnosis 167, 169–171
 - Fan speeds 170
 - SPI 171
 - Start up 167, 169
 - Temperatures 169
- Error logging 172
 - Start up 172
- Identification 166
- Internal service patterns 173
- Overview flow 165
- Refill mode 176
- Reset formatter 175
- Restore factory defaults 174
- Save custom settings 176
- USB memory 178
- Versions 167
 - Start up 167
- Voltages 168
 - Start up 168
- Service patterns 173
 - Internal patterns 173
- Servicing 185
- Sharpness 74
- Shift range 16
- Shortcut keys 56
- Shutdown, automatic 66
 - No signal 66
 - Retarding time 66

Side keystone 120
Size 96
 Main window 96
Source 37
 Connection 37
Source files 205
Source selection 53
Source switching 65
Source timings 83
Spare parts 229
Spare power plug 36
Specifications 221, 224–227
 5 cable input 224
 DVI HDCP 227
 DVI input 226
 FLM R22+ 221
 HDSI–SDI input 225
SPI 171
 Diagnosis 171
Stacked 33
 Align 33
Stacking 31
Start up 46, 55
 Adjustment mode 55
 Errors and warnings 46
Startup errors 46
Startup warnings 46
Suspend 28
 Projector 28
Switching off 47
Switching to standby 46

T

Table mount 27
 Align 27
Temperatures 169
 Diagnosis 169
Test patterns 57
 Adjustment mode 57
Text on/off 49
Tilt range 17
Timings 83
Tint 73

Troubleshooting 213
 Error codes 213

U

Unpacking 12
USB memory 178
USB port 41

V

Versions 167
 Start up 167
Volt meter 36
Voltages 168
 Start up 168

W

Warnings 7
 Cooling liquid circuit 7
Warp geometry settings 121–129
 4 corners 127
 About 121
 Barrel correction 126
 Horizontal keystone 123
 Load warp file 129
 Pincushion correction 126
 Reset 128
 Rotation 125
 Vertical keystone 124
 Warp status 122
Window 95, 100
 PIP window 100

Z

Z-axis 115
 Lamp 115
Z-axis adjustment 115
Zoom - Focus 109
 Layout 109

Revision Sheet

To:

► **Barco nv Media & Entertainment Division/Documentation**
Noordlaan 5, B-8520 Kuurne
Phone: +32 56.36.82.11, Fax: +32 56.36.88.24
E-mail: service.mne@barco.com, Web: www.barco.com

From: _____

Date: _____

Please correct the following points in this documentation (**R59770179/04**):

page	wrong	correct